

# Dell™ Chassis Management Controller Firmware Version 1.1 User Guide

# Notes and Notices



**NOTE:** A NOTE indicates important information that helps you make better use of your computer.



**NOTICE:** A NOTICE indicates either potential damage to hardware or loss of data and tells you how to avoid the problem.

---

**Information in this document is subject to change without notice.**

© 2008 Dell Inc. All rights reserved.

Reproduction of these materials in any manner whatsoever without the written permission of Dell Inc. is strictly forbidden.

Trademarks used in this text: *Dell*, the *DELL* logo, *OpenManage*, and *PowerEdge* are trademarks of Dell Inc.; *Microsoft*, *Active Directory*, *Internet Explorer*, *Windows*, *Windows NT*, *Windows Server*, and *Windows Vista* are either trademarks or registered trademarks of Microsoft Corporation in the United States and other countries; *Red Hat* and *Red Hat Enterprise Linux* are registered trademarks of Red Hat, Inc.; *Novell* and *SUSE* are registered trademarks of Novell Corporation in the United States and other countries; *Intel* is a registered trademark of Intel Corporation; *UNIX* is a registered trademark of The Open Group in the United States and other countries. *Avocent* is a trademark of Avocent Corporation; *OSCAR* is a registered trademark of Avocent Corporation or its affiliates.

Copyright 1998-2006 The OpenLDAP Foundation. All rights reserved. Redistribution and use in source and binary forms, with or without modification, are permitted only as authorized by the OpenLDAP Public License. A copy of this license is available in the file LICENSE in the top-level directory of the distribution or, alternatively, at <http://www.OpenLDAP.org/license.html>. OpenLDAP is a registered trademark of the OpenLDAP Foundation. Individual files and/or contributed packages may be copyrighted by other parties and subject to additional restrictions. This work is derived from the University of Michigan LDAP v3.3 distribution. This work also contains materials derived from public sources. Information about OpenLDAP can be obtained at <http://www.openldap.org/>. Portions Copyright 1998-2004 Kurt D. Zeilenga. Portions Copyright 1998-2004 Net Boolean Incorporated. Portions Copyright 2001-2004 IBM Corporation. All rights reserved. Redistribution and use in source and binary forms, with or without modification, are permitted only as authorized by the OpenLDAP Public License. Portions Copyright 1999-2003 Howard Y.H. Chu. Portions Copyright 1999-2003 Symas Corporation. Portions Copyright 1998-2003 Hallvard B. Furuseth. All rights reserved. Redistribution and use in source and binary forms, with or without modification, are permitted provided that this notice is preserved. The names of the copyright holders may not be used to endorse or promote products derived from this software without their specific prior written permission. This software is provided "as is" without express or implied warranty. Portions Copyright (c) 1992-1996 Regents of the University of Michigan. All rights reserved. Redistribution and use in source and binary forms are permitted provided that this notice is preserved and that due credit is given to the University of Michigan at Ann Arbor. The name of the University may not be used to endorse or promote products derived from this software without specific prior written permission. This software is provided "as is" without express or implied warranty.

Other trademarks and trade names may be used in this document to refer to either the entities claiming the marks and names or their products. Dell Inc. disclaims any proprietary interest in trademarks and trade names other than its own.

June 2008

Rev. A00

# Contents

1	CMC Overview . . . . .	23
	<b>CMC Management Features</b> . . . . .	23
	<b>Security Features</b> . . . . .	24
	<b>Chassis Overview</b> . . . . .	25
	<b>Hardware Specifications</b> . . . . .	25
	TCP/IP Ports . . . . .	25
	<b>Supported Remote Access Connections</b> . . . . .	27
	<b>Supported Platforms</b> . . . . .	27
	<b>Supported Web Browsers</b> . . . . .	27
	<b>Supported Management Console Applications</b> . . . . .	28
	<b>WS-Management Support</b> . . . . .	28
	<b>Other Documents You May Need</b> . . . . .	30
2	Installing and Setting Up the CMC . . . . .	33
	<b>Before You Begin</b> . . . . .	33
	<b>Installing the CMC Hardware</b> . . . . .	33

<b>Installing Remote Access Software on a Management Station . . . . .</b>	<b>34</b>
Installing RACADM on a Linux Management Station . . . . .	35
Uninstalling RACADM From a Linux Management Station . . . . .	35
<b>Configuring a Web Browser . . . . .</b>	<b>35</b>
Proxy Server . . . . .	36
Microsoft® Phishing Filter . . . . .	37
Certificate Revocation List (CRL) Fetching . . . . .	37
Downloading Files From CMC With Internet Explorer . . . . .	38
Allow Animations in Internet Explorer . . . . .	38
<b>Setting Up Initial Access to the CMC . . . . .</b>	<b>38</b>
Basic CMC Network Connection . . . . .	39
Daisy-chain CMC Network Connection . . . . .	39
Configuring the CMC Network . . . . .	41
Configuring Networking Using the LCD Configuration Wizard . . . . .	42
<b>Accessing the CMC Through a Network . . . . .</b>	<b>46</b>
<b>Installing or Updating the CMC Firmware. . . . .</b>	<b>48</b>
Downloading the CMC Firmware . . . . .	48
<b>Configuring CMC Properties . . . . .</b>	<b>49</b>
Configuring Power Budgeting . . . . .	50
Configuring CMC Network Settings . . . . .	50
Adding and Configuring Users . . . . .	50
Adding SNMP and E-mail Alerts . . . . .	51
<b>Understanding the Redundant CMC Environment. . . . .</b>	<b>51</b>
About the Standby CMC . . . . .	51
Primary CMC Election Process . . . . .	52

	Planning Deployment of Redundant CMCs . . . . .	52
	Obtaining Health Status of Redundant CMC . . . . .	52
<b>3</b>	<b>Configuring CMC to Use Command Line Consoles . . . . .</b>	<b>53</b>
	<b>Command Line Console Features on the CMC . . . . .</b>	<b>53</b>
	<b>Using a Telnet Console With the CMC . . . . .</b>	<b>53</b>
	<b>Using SSH With the CMC . . . . .</b>	<b>54</b>
	Enabling SSH on the CMC . . . . .	54
	Changing the SSH Port . . . . .	54
	Enabling the Front Panel to iKVM Connection . . . . .	55
	<b>Configuring Terminal Emulation Software . . . . .</b>	<b>55</b>
	Configuring Linux Minicom for Serial Console Emulation . . . . .	56
	Configuring Linux for Serial Console Redirection During Boot . . . . .	58
	Enabling Login to the Console After Boot . . . . .	60
	<b>Using a Serial or Telnet Console . . . . .</b>	<b>63</b>
	<b>Connecting to Modules With the Connect Command . . . . .</b>	<b>63</b>
<b>4</b>	<b>Using the RACADM Command Line Interface . . . . .</b>	<b>65</b>
	<b>Using a Serial or Telnet Console . . . . .</b>	<b>66</b>
	Logging in to the CMC . . . . .	66
	Starting a Text Console . . . . .	66

<b>Using RACADM</b> . . . . .	<b>66</b>
RACADM Subcommands . . . . .	67
Accessing RACADM Remotely . . . . .	70
Enabling and Disabling the RACADM Remote Capability . . . . .	71
Using RACADM Remotely. . . . .	71
RACADM Error Messages . . . . .	72
<b>Using RACADM to Configure the CMC</b> . . . . .	<b>72</b>
<b>Configuring CMC Network Properties</b> . . . . .	<b>72</b>
Setting Up Initial Access to the CMC. . . . .	72
Viewing Current Network Settings . . . . .	73
Configuring the Network LAN Settings. . . . .	74
Configuring the Network Security Settings. . . . .	77
<b>Using RACADM to Configure Users</b> . . . . .	<b>77</b>
Before You Begin . . . . .	77
Adding a CMC User. . . . .	78
Enabling a CMC User With Permissions . . . . .	79
Disabling a CMC User. . . . .	79
<b>Configuring SNMP and E-mail Alerting</b> . . . . .	<b>80</b>
<b>Configuring Multiple CMCs in Multiple Chassis</b> . . . . .	<b>80</b>
Creating a CMC Configuration File . . . . .	81
Parsing Rules . . . . .	83
Modifying the CMC IP Address. . . . .	85
<b>Troubleshooting</b> . . . . .	<b>86</b>

<b>5</b>	<b>Using the CMC Web Interface . . . . .</b>	<b>87</b>
	<b>    Accessing the CMC Web Interface . . . . .</b>	<b>87</b>
	Logging In. . . . .	88
	Logging Out. . . . .	88
	<b>    Configuring Basic CMC Settings . . . . .</b>	<b>89</b>
	Setting the Chassis Name . . . . .	89
	Setting the Date and Time on the CMC. . . . .	89
	<b>    Monitoring System Health Status . . . . .</b>	<b>89</b>
	Viewing Chassis and Component Summaries . . . . .	89
	Viewing Chassis and Component Health Status . . . . .	89
	Viewing Power Budget Status . . . . .	90
	Viewing the Health Status of All Servers. . . . .	90
	Editing Slot Names . . . . .	91
	Setting the First Boot Device for Servers . . . . .	92
	Viewing the Health Status of an Individual Server. . . . .	94
	Viewing the Health Status of IOMs. . . . .	96
	Viewing the Health Status of the Fans . . . . .	96
	Viewing the iKVM Status . . . . .	97
	Viewing the Health Status of the PSUs. . . . .	97
	Viewing Status of the Temperature Sensors. . . . .	99
	<b>    Configuring CMC Network Properties . . . . .</b>	<b>100</b>
	Setting Up Initial Access to the CMC. . . . .	100
	Configuring the Network LAN Settings. . . . .	100
	Configuring CMC Network Security Settings . . . . .	105
	<b>    Adding and Configuring CMC Users. . . . .</b>	<b>107</b>
	User Types . . . . .	107
	Adding and Managing Users . . . . .	114

<b>Configuring and Managing Microsoft Active Directory Certificates</b> . . . . .	<b>117</b>
Configuring Active Directory (Standard Schema and Extended Schema) . . . . .	118
Uploading an Active Directory Certificate Authority-Signed Certificate . . . . .	122
Viewing an Active Directory Certificate Authority-Signed Certificate . . . . .	122
<b>Securing CMC Communications Using SSL and Digital Certificates</b> . . . . .	<b>123</b>
Secure Sockets Layer (SSL) . . . . .	123
Certificate Signing Request (CSR) . . . . .	124
Accessing the SSL Main Menu . . . . .	124
Generating a New Certificate Signing Request . . . . .	125
Uploading a Server Certificate . . . . .	128
Viewing a Server Certificate . . . . .	128
<b>Managing Sessions</b> . . . . .	<b>129</b>
<b>Configuring Services</b> . . . . .	<b>130</b>
<b>Configuring Power Budgeting</b> . . . . .	<b>137</b>
<b>Managing Firmware</b> . . . . .	<b>138</b>
Viewing the Current Firmware Versions . . . . .	138
Updating CMC and iKVM Firmware . . . . .	138
Recovering iDRAC Firmware Using the CMC . . . . .	140
<b>FlexAddress</b> . . . . .	<b>141</b>
Viewing FlexAddress Status . . . . .	142
Configuring FlexAddress . . . . .	145
Chassis-Level Fabric and Slot FlexAddress Configuration . . . . .	145



Server-Level Slot FlexAddress Configuration . . . . .	146
<b>Frequently Asked Questions</b> . . . . .	<b>148</b>
<b>Troubleshooting the CMC</b> . . . . .	<b>150</b>
<b>6 Using FlexAddress</b> . . . . .	<b>151</b>
<b>Activating FlexAddress</b> . . . . .	<b>152</b>
Verifying FlexAddress Activation. . . . .	153
<b>Deactivating FlexAddress</b> . . . . .	<b>155</b>
Deactivating FlexAddress . . . . .	155
<b>Viewing FlexAddress Status Using the CLI</b> . . . . .	<b>156</b>
<b>Configuring FlexAddress Using the CLI</b> . . . . .	<b>156</b>
Additional FlexAddress Configuration for Linux . . . . .	157
<b>Wake-On-LAN with FlexAddress</b> . . . . .	<b>157</b>
<b>Troubleshooting FlexAddress</b> . . . . .	<b>158</b>
<b>FlexAddress DELL SOFTWARE LICENSE AGREEMENT</b> . . . . .	<b>163</b>
<b>7 Using the CMC With Microsoft Active Directory</b> . . . . .	<b>167</b>
<b>Active Directory Schema Extensions</b> . . . . .	<b>167</b>
Extended Schema Versus Standard Schema . . . . .	167
<b>Extended Schema Overview</b> . . . . .	<b>168</b>
Active Directory Schema Extensions . . . . .	168
Overview of the RAC Schema Extensions . . . . .	168

Active Directory Object Overview . . . . .	169
Configuring Extended Schema Active Directory to Access Your CMC . . . . .	173
Extending the Active Directory Schema . . . . .	173
Installing the Dell Extension to the Active Directory Users and Computers Snap-In. . . . .	179
Adding CMC Users and Privileges to Active Directory . . . . .	180
Configuring the CMC With Extended Schema Active Directory and the Web Interface . . . . .	183
Configuring the CMC With Extended Schema Active Directory and RACADM . . . . .	185
<b>Standard Schema Active Directory Overview. . . . .</b>	<b>187</b>
Configuring Standard Schema Active Directory to Access Your CMC . . . . .	190
Configuring the CMC With Standard Schema Active Directory and Web Interface . . . . .	190
Configuring the CMC With Standard Schema Active Directory and RACADM . . . . .	193
<b>Frequently Asked Questions. . . . .</b>	<b>194</b>
<b>8 Power Management. . . . .</b>	<b>197</b>
<b>Overview. . . . .</b>	<b>197</b>
Power Budgeting for Hardware Modules . . . . .	197
Dynamic PSU Engagement . . . . .	198
<b>Redundancy Policies. . . . .</b>	<b>199</b>
AC Redundancy. . . . .	200
Power Supply Redundancy. . . . .	200
No Redundancy. . . . .	201
Power Conservation and Power Budget Changes. . . . .	201

<b>Configuring and Managing Power</b> . . . . .	<b>205</b>
Viewing the Health Status of the PSUs. . . . .	205
Viewing Power Budget Status . . . . .	207
Configuring Power Budget and Redundancy . . . . .	213
Assigning Priority Levels to Servers . . . . .	217
Setting the Power Budget . . . . .	218
Setting the Power Warning Threshold . . . . .	219
Enabling Throttling to Maintain Power Budget . . . . .	220
Executing Power Control Operations on the Chassis . . . . .	221
Executing Power Control Operations on an IOM . . . . .	222
Executing Power Control Operations on a Server. . . . .	223
<b>9 Using the iKVM Module.</b> . . . . .	<b>225</b>
<b>Overview.</b> . . . . .	<b>225</b>
iKVM User Interface . . . . .	225
Security . . . . .	225
Scanning . . . . .	225
Server Identification . . . . .	225
Video . . . . .	226
Plug and Play . . . . .	226
FLASH Upgradable . . . . .	226
<b>Physical Connection Interfaces</b> . . . . .	<b>226</b>
iKVM Connection Precedences . . . . .	226
Tiering Through the ACI Connection . . . . .	227
<b>Using OSCAR.</b> . . . . .	<b>227</b>
Navigation Basics . . . . .	227
Configuring OSCAR. . . . .	229

<b>Managing Servers With iKVM</b> . . . . .	<b>231</b>
Peripherals Compatibility and Support . . . . .	231
Viewing and Selecting Servers . . . . .	232
Setting Console Security . . . . .	235
Scanning Your System . . . . .	240
Broadcasting to Servers . . . . .	241
<b>Managing iKVM From the CMC</b> . . . . .	<b>243</b>
Enabling or Disabling the Front Panel . . . . .	243
Enabling the Dell CMC Console via iKVM. . . . .	243
Viewing the iKVM Status and Properties. . . . .	244
Updating the iKVM Firmware . . . . .	245
<b>Troubleshooting</b> . . . . .	<b>246</b>
<b>10 I/O Fabric Management</b> . . . . .	<b>251</b>
<b>Fabric Management</b> . . . . .	<b>251</b>
<b>Invalid Configurations</b> . . . . .	<b>253</b>
Invalid MC Configuration . . . . .	253
Invalid IOM-MC Configuration . . . . .	253
Invalid IOM-IOM Configuration . . . . .	253
<b>Fresh Power-up Scenario</b> . . . . .	<b>254</b>
<b>Monitoring IOM Health</b> . . . . .	<b>254</b>
Viewing the Health Status of an Individual IOM . . . . .	256

<b>11 Troubleshooting and Recovery . . . . .</b>	<b>259</b>
<b>Overview . . . . .</b>	<b>259</b>
<b>Chassis Monitoring Tools . . . . .</b>	<b>259</b>
Configuring LEDs to Identify Components on the Chassis . . . . .	259
Configuring SNMP Alerts . . . . .	260
Configuring E-mail Alerts . . . . .	265
<b>First Steps to Troubleshooting a Remote System . . . . .</b>	<b>268</b>
<b>Monitoring Power and Executing Power Control     Commands on the Chassis . . . . .</b>	<b>268</b>
Viewing Power Budget Status . . . . .	268
Executing a Power Control Operation . . . . .	268
<b>Viewing Chassis Summaries . . . . .</b>	<b>268</b>
<b>Viewing Chassis and Component Health Status . . . . .</b>	<b>272</b>
<b>Viewing the Event Logs . . . . .</b>	<b>273</b>
Viewing the Hardware Log . . . . .	273
Viewing the CMC Log . . . . .	275
<b>Using the Diagnostic Console . . . . .</b>	<b>277</b>
<b>Interpreting LED Colors and Blinking Patterns . . . . .</b>	<b>278</b>
<b>Troubleshooting a Non-responsive CMC . . . . .</b>	<b>281</b>
Observing the LEDs to Isolate the Problem . . . . .	281
Obtain Recovery Information From the DB-9 Serial Port . . . . .	281
Recovering the Firmware Image . . . . .	282
<b>Troubleshooting Network Problems . . . . .</b>	<b>283</b>
<b>Troubleshooting Alerting . . . . .</b>	<b>283</b>

A RACADM Subcommands . . . . .	285
? and ? <command> . . . . .	285
arp . . . . .	286
chassisaction . . . . .	287
clrraclog . . . . .	288
clrsel . . . . .	289
cmcchangeover . . . . .	289
config . . . . .	290
deploy . . . . .	292
feature . . . . .	294
featurecard . . . . .	295
fwupdate . . . . .	296
getassettag . . . . .	298
getchassisname . . . . .	299
getconfig . . . . .	299
getdcinfo . . . . .	302
getflexaddr . . . . .	303
getioinfo . . . . .	305
getkvminfo . . . . .	306
getled . . . . .	306
getmacaddress . . . . .	307

<b>getmodinfo</b> . . . . .	<b>308</b>
<b>getniccfg</b> . . . . .	<b>309</b>
<b>getpbinfo</b> . . . . .	<b>311</b>
<b>getraclog</b> . . . . .	<b>313</b>
<b>getractime</b> . . . . .	<b>314</b>
<b>getredundancymode</b> . . . . .	<b>315</b>
<b>getsel</b> . . . . .	<b>315</b>
<b>getsensorinfo</b> . . . . .	<b>316</b>
<b>getslotname</b> . . . . .	<b>317</b>
<b>getssninfo</b> . . . . .	<b>318</b>
<b>getsvctag</b> . . . . .	<b>319</b>
<b>getsysinfo</b> . . . . .	<b>321</b>
<b>gettracelog</b> . . . . .	<b>322</b>
<b>help and help &lt;command&gt;</b> . . . . .	<b>324</b>
<b>ifconfig</b> . . . . .	<b>325</b>
<b>netstat</b> . . . . .	<b>325</b>
<b>ping</b> . . . . .	<b>326</b>
<b>racdump</b> . . . . .	<b>326</b>
<b>racreset</b> . . . . .	<b>329</b>
<b>racresetcfg</b> . . . . .	<b>330</b>
<b>serveraction</b> . . . . .	<b>331</b>

<b>setchassisname</b> . . . . .	<b>332</b>
<b>setassettag</b> . . . . .	<b>333</b>
<b>setflexaddr</b> . . . . .	<b>333</b>
<b>setled</b> . . . . .	<b>335</b>
<b>setniccfg</b> . . . . .	<b>335</b>
<b>setractime</b> . . . . .	<b>337</b>
<b>setslotname</b> . . . . .	<b>339</b>
<b>setsysinfo</b> . . . . .	<b>340</b>
<b>sslcertdownload</b> . . . . .	<b>340</b>
<b>sslcertupload</b> . . . . .	<b>341</b>
<b>sslcertview</b> . . . . .	<b>342</b>
<b>sslcsrgen</b> . . . . .	<b>344</b>
<b>testemail</b> . . . . .	<b>345</b>
<b>testtrap</b> . . . . .	<b>346</b>

## **B CMC Property Database Group and Object Definitions . . . . . 347**

<b>Displayable Characters</b> . . . . .	<b>347</b>
<b>idRacInfo (read only)</b> . . . . .	<b>347</b>
#idRacType . . . . .	348
#idRacProductInfo . . . . .	348
#idRacDescriptionInfo . . . . .	348
#idRacVersionInfo . . . . .	348



#idRacBuildInfo . . . . .	348
#idRacName . . . . .	348
<b>cfgLanNetworking . . . . .</b>	<b>349</b>
cfgNicEnable . . . . .	349
cfgNicIpAddress . . . . .	349
cfgNicNetmask . . . . .	349
cfgNicGateway . . . . .	350
cfgDNSServersFromDHCP (Read/Write) . . . . .	350
cfgDNSServer1 (Read/Write) . . . . .	350
cfgDNSServer2 (Read/Write) . . . . .	350
cfgDNSRacName . . . . .	351
cfgDNSDomainName . . . . .	351
cfgDNSDomainNameFromDHCP . . . . .	351
cfgDNSRegisterRac . . . . .	351
<b>cfgCurrentLanNetworking (read only) . . . . .</b>	<b>352</b>
# cfgNicCurrentIpAddress . . . . .	352
# cfgNicCurrentNetmask . . . . .	352
# cfgNicCurrentGateway . . . . .	352
# cfgNicCurrentDhcpWasUsed . . . . .	352
# cfgDNSCurrentServer1 . . . . .	353
# cfgDNSCurrentServer1 . . . . .	353
# cfgDNSCurrentDomainName . . . . .	353
<b>cfgRemoteHosts . . . . .</b>	<b>353</b>
cfgRhostsFwUpdateTftpEnable . . . . .	353
cfgRhostsFwUpdateIpAddr . . . . .	354
cfgRhostsFwUpdatePath . . . . .	354
cfgRhostsSmtServerIpAddr . . . . .	354
<b>cfgUserAdmin . . . . .</b>	<b>354</b>
# cfgUserAdminIndex . . . . .	355
cfgUserAdminEnable . . . . .	355
cfgUserAdminUserName . . . . .	355

# cfgUserAdminPassword . . . . .	355
cfgUserAdminPrivilege . . . . .	356
<b>cfgEmailAlert . . . . .</b>	<b>357</b>
# cfgEmailAlertIndex . . . . .	357
cfgEmailAlertEnable . . . . .	357
# cfgEmailAlertAddress . . . . .	358
cfgEmailAlertEmailName . . . . .	358
<b>cfgSessionManagement . . . . .</b>	<b>358</b>
cfgSsnMgtWebserverTimeout . . . . .	359
cfgSsnMgtTelnetIdleTimeout . . . . .	359
cfgSsnMgtSshIdleTimeout . . . . .	359
cfgSsnMgtRacadmTimeout . . . . .	359
<b>cfgSerial . . . . .</b>	<b>360</b>
cfgSerialBaudRate . . . . .	360
cfgSerialConsoleEnable . . . . .	360
cfgSerialConsoleQuitKey . . . . .	360
cfgSerialConsoleIdleTimeout . . . . .	361
cfgSerialConsoleCommand . . . . .	361
cfgSerialConsoleHistorySize . . . . .	361
cfgSerialTelnetEnable . . . . .	361
cfgSerialSshEnable . . . . .	361
<b>cfgNetTuning . . . . .</b>	<b>362</b>
cfgNetTuningNicSpeed . . . . .	362
cfgNetTuningNicFullDuplex . . . . .	362
cfgNetTuningNicMtu . . . . .	363
cfgNetTuningNicAutoneg . . . . .	363
<b>cfgOobSnmp . . . . .</b>	<b>363</b>
cfgOobSnmpAgentEnable . . . . .	363
cfgOobSnmpAgentCommunity . . . . .	364

<b>cfgTraps</b> . . . . .	<b>364</b>
# cfgTrapsIndex. . . . .	364
cfgTrapsEnable . . . . .	364
cfgTrapsAlertDestIpAddr . . . . .	364
cfgTrapsCommunityName . . . . .	365
<b>cfgAlerting</b> . . . . .	<b>365</b>
cfgAlertingEnable. . . . .	365
cfgAlertingFilterMask . . . . .	365
<b>cfgRacTuning</b> . . . . .	<b>366</b>
cfgRacTuneRemoteRacadmEnable . . . . .	366
cfgRacTuneWebserverEnable . . . . .	366
cfgRacTuneHttpPort . . . . .	366
cfgRacTuneHttpsPort. . . . .	367
cfgRacTuneTelnetPort . . . . .	367
cfgRacTuneSshPort . . . . .	367
cfgRacTunelpRangeEnable. . . . .	367
cfgRacTunelpRangeAddr. . . . .	367
cfgRacTunelpRangeMask . . . . .	368
cfgRacTunelpBlkEnable . . . . .	368
cfgRacTunelpBlkFailCount . . . . .	368
cfgRacTunelpBlkFailWindow. . . . .	368
cfgRacTunelpBlkPenaltyTime . . . . .	368
cfgRacTuneTimezoneOffset . . . . .	369
cfgRacTuneDaylightOffset . . . . .	369
<b>cfgRacSecurity</b> . . . . .	<b>369</b>
cfgRacSecCsrKeySize . . . . .	370
cfgRacSecCsrCommonName . . . . .	370
cfgRacSecCsrOrganizationName . . . . .	370
cfgRacSecCsrOrganizationUnit . . . . .	370
cfgRacSecCsrLocalityName . . . . .	370
cfgRacSecCsrStateName . . . . .	370

cfgRacSecCsrCountryCode . . . . .	371
cfgRacSecCsrEmailAddr . . . . .	371
<b>cfgActiveDirectory . . . . .</b>	<b>371</b>
cfgADEnable . . . . .	372
cfgADRacDomain . . . . .	372
cfgADRootDomain . . . . .	372
cfgADRacName . . . . .	372
cfgADAuthTimeout . . . . .	372
cfgADType . . . . .	372
cfgADSpecifyServerEnable . . . . .	373
cfgADDomainController . . . . .	373
cfgADGlobalCatalog . . . . .	373
<b>cfgStandardSchema . . . . .</b>	<b>373</b>
# cfgSSADRoleGroupIndex . . . . .	374
cfgSSADRoleGroupName . . . . .	374
cfgSSADRoleGroupDomain . . . . .	374
cfgSSADRoleGroupPrivilege . . . . .	374
<b>cfgChassisPower . . . . .</b>	<b>375</b>
# cfgChassisActualACPowerConsumption . . . . .	375
# cfgChassisPeakPowerConsumption . . . . .	375
# cfgChassisPeakPowerConsumptionTimestamp . . . . .	375
# cfgChassisMinPowerConsumption . . . . .	375
# cfgChassisMinPowerConsumptionTimestamp . . . . .	375
# cfgChassisPowerStatus . . . . .	375
# cfgChassisRedundantState . . . . .	376
cfgChassisMaxACPowerLimit . . . . .	376
cfgChassisACPowerWarningThreshold . . . . .	376
cfgChassisServerPowerThrottling . . . . .	376
cfgChassisRedundancyPolicy . . . . .	376
cfgChassisDynamicPSUEngagementEnable . . . . .	376
# cfgChassisDCMaxPowerCapacity . . . . .	377

# cfgChassisDCRedundancyReserve . . . . .	377
cfgChassisDCPowerServerAllocation . . . . .	377
# cfgChassisInfrastructureDCPowerAllocation . . . . .	377
# cfgChassisTotalDCPowerAvailable . . . . .	377
# cfgChassisStandbyPowerCapacity . . . . .	377
# cfgChassisPowerConsumptionClear . . . . .	378
# cfgChassisPowerConsumptionClearTimestamp . . . . .	378
cfgChassisPowerButtonEnable . . . . .	378
<b>cfgServerInfo . . . . .</b>	<b>379</b>
# cfgServerInfoIndex . . . . .	379
# cfgServerSlotNumber . . . . .	379
# cfgServerServiceTag . . . . .	379
cfgServerName . . . . .	379
# cfgServerNic1MacAddress . . . . .	380
# cfgServerNic2MacAddress . . . . .	380
cfgServerPriority . . . . .	380
cfgServerNicEnable . . . . .	380
cfgServerIPMIOverLanEnable . . . . .	380
<b>cfgKVMInfo . . . . .</b>	<b>381</b>
cfgKVMAccessToCMCEnable . . . . .	381
cfgKVMFrontPanelEnable . . . . .	381

## C Using the LCD Panel Interface . . . . . 383

<b>LCD Navigation . . . . .</b>	<b>383</b>
Main Menu . . . . .	383
LCD Setup Menu . . . . .	384
Language Setup Screen . . . . .	384
Default Screen . . . . .	384
Graphical Server Status Screen . . . . .	385
Graphical Module Status Screen . . . . .	386
Enclosure Menu Screen . . . . .	386

Module Status Screen . . . . .	387
Server Status Screen . . . . .	387
IP Summary Screen. . . . .	387
<b>Diagnostics. . . . .</b>	<b>387</b>
<b>LCD Hardware Troubleshooting . . . . .</b>	<b>388</b>
<b>Front Panel LCD Messages . . . . .</b>	<b>391</b>
<b>LCD Error Messages . . . . .</b>	<b>392</b>
<b>LCD Module and Server Status Information. . . . .</b>	<b>402</b>
Glossary . . . . .	407
Index . . . . .	415

# CMC Overview

The Dell™ Chassis Management Controller (CMC) is a hot-pluggable systems management hardware and software solution designed to provide remote management capabilities and power control functions for Dell M1000e chassis systems.

You can configure the CMC to send e-mail alerts or SNMP trap alerts for warnings or errors related to temperatures, hardware misconfigurations, power outages, and fan speeds.

The CMC, which has its own microprocessor and memory, is powered by the modular chassis into which it is plugged.

To get started with the CMC, see "Installing and Setting Up the CMC" on page 33.

## CMC Management Features

The CMC provides the following management features:

- Dynamic Domain Name System (DNS) registration
- Remote system management and monitoring using SNMP, a Web interface, iKVM, or Telnet/SSH connection
- Support for Microsoft® Active Directory™ authentication — Centralizes CMC user IDs and passwords in Active Directory using the Standard Schema or an Extended Schema
- Monitoring — Provides access to system information and status of components
- Access to system event logs — Provides access to the hardware log and CMC log
- Dell OpenManage™ software integration — Enables you to launch the CMC Web interface from Dell OpenManage Server Administrator or IT Assistant
- CMC alert — Alerts you to potential managed node issues through an e-mail message or SNMP trap

- Remote power management — Provides remote power management functions, such as shutdown and reset on any chassis component, from a management console
- Secure Sockets Layer (SSL) encryption — Provides secure remote system management through the Web interface
- Password-level security management — Prevents unauthorized access to a remote system
- Role-based authority — Provides assignable permissions for different systems management tasks
- Launch point for the Integrated Dell Remote Access Controller (iDRAC) Web interface
- Support for WS-Management (for more information, see "WS-Management Support" on page 28)
- FlexAddress feature - Replaces the factory-assigned World Wide Name/Media Access Control (WWN/MAC) IDs with chassis assigned WWN/MAC IDs for a particular slot; an optional upgrade in CMC 1.1 (for more information, see "Using FlexAddress" on page 151)

## Security Features

The CMC provides the following security features:

- User authentication through Microsoft Active Directory (optional) or hardware-stored user IDs and passwords
- Role-based authority, which enables an administrator to configure specific privileges for each user
- User ID and password configuration through the Web interface
- Web interface supports 128-bit SSL encryption and 40-bit SSL encryption (for countries where 128-bit is not acceptable)



**NOTE:** Telnet does not support SSL encryption.

- Configurable IP ports (where applicable)
- Login failure limits per IP address, with login blocking from the IP address when the limit is exceeded
- Limited IP address range for clients connecting to the CMC
- Secure Shell (SSH), which uses an encrypted layer for higher security



# Chassis Overview

Figure 1-1 shows the facing edge of a CMC (inset) and the locations of the CMC slots in the chassis.

**Figure 1-1. Dell M1000e Chassis and CMC**

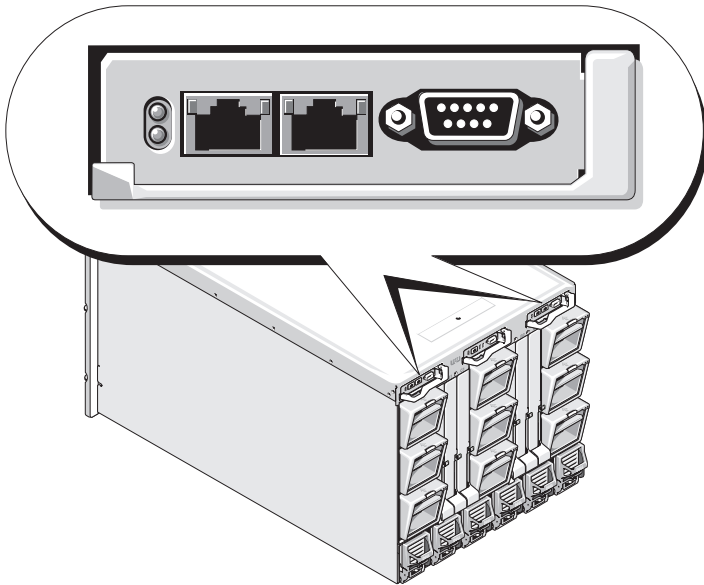

## Hardware Specifications

### TCP/IP Ports

You must provide port information when opening firewalls for remote access to a CMC.

Table 1-1 identifies the ports on which the CMC listens for server connections. Table 1-2 identifies the ports that the CMC uses as clients.

**Table 1-1. CMC Server Listening Ports**

<b>Port Number</b>	<b>Function</b>
22*	SSH
23*	Telnet
80*	HTTP
161	SNMP Agent
443*	HTTPS

\* Configurable port

**Table 1-2. CMC Client Port**

<b>Port Number</b>	<b>Function</b>
25	SMTP
53	DNS
68	DHCP-assigned IP address
69	TFTP
162	SNMP trap
636	LDAPS
3269	LDAPS for global catalog (GC)

# Supported Remote Access Connections

Table 1-3 lists the connection features.

**Table 1-3. Supported Remote Access Connections**

Connection	Features
CMC NIC	<ul style="list-style-type: none"><li>• 10Mbps/100Mbps/1Gbps Ethernet via CMC GbE port</li><li>• DHCP support</li><li>• SNMP traps and e-mail event notification</li><li>• Dedicated network interface for the CMC Web interface</li><li>• Network interface for the iDRAC and I/O Modules (IOMs)</li><li>• Support for Telnet/SSH command console and RACADM CLI commands including system boot, reset, power-on, and shutdown commands</li></ul>
Serial port	<ul style="list-style-type: none"><li>• Support for serial console and RACADM CLI commands including system boot, reset, power-on, and shutdown commands</li><li>• Support for binary interchange for applications specifically designed to communicate with a binary protocol to a particular type of IOM</li><li>• Serial port can be switched to IOMs using the <code>connect</code> command</li></ul>
Other connections	<ul style="list-style-type: none"><li>• Access to the Dell CMC Console through the Avocent<sup>®</sup> Integrated KVM Switch Module (iKVM)</li></ul>

## Supported Platforms

The CMC supports modular systems designed for the M1000e platform. For information about compatibility with the CMC, see the documentation for your device.

For the latest supported platforms, see the *Dell PowerEdge Compatibility Guide* located on the Dell Support website at [support.dell.com](http://support.dell.com).

## Supported Web Browsers

Table 1-4 lists the Web browsers supported as CMC clients.

For the latest information on supported Web browsers, see the *Dell OpenManage Server Administrator Compatibility Guide* located on the Dell Support website at [support.dell.com](http://support.dell.com).

**Table 1-4. Supported Web Browsers**

<b>Operating System</b>	<b>Supported Web Browser</b>
Windows <sup>®</sup>	Internet Explorer <sup>®</sup> 6.0 (32-bit) with Service Pack 2 (SP2) for Windows XP and Windows 2003 R2 SP2 only.  Internet Explorer 7.0 for Windows Vista <sup>®</sup> , Windows XP, and Windows 2003 R2 SP2 only.
Linux	Mozilla Firefox 1.5 (32-bit) for SUSE <sup>®</sup> Enterprise Linux (version 10) only.  Mozilla Firefox 2.0 (32-bit).

To view localized versions of the CMC Web interface:

- 1 Open the **Windows Control Panel**.
- 2 Double-click the **Regional Options** icon.
- 3 Select the desired locale from the **Your locale (location)** drop-down menu.

## Supported Management Console Applications

The CMC supports integration with Dell OpenManage IT Assistant. For more information, refer to the documentation for the OpenManage IT Assistant.

## WS-Management Support

The CMC firmware includes an implementation of the WS-Management specification. WS-Management, a new Web Services specification over SOAP-based protocol for systems management, provides a universal language for devices to share data so they can be managed more easily.

Access to WS-Management requires Administrator (or root) user privileges using Basic authentication over Secured Socket Layer (SSL) protocol at port 443. For information on setting user accounts, see "cfgSessionManagement" on page 358.

The data available through WS-Management is a subset of data provided by the CMC instrumentation interface mapped to the following DMTF profiles version 1.0.0:

- Allocation Capabilities Profile
- Base Metrics Profile
- Base Server Profile
- Computer System Profile
- Modular System Profile
- Physical Asset Profile
- Dell Power Allocation Profile
- Dell Power Supply Profile
- Dell Power Topology Profile
- Power State Management Profile
- Profile Registration Profile
- Record Log Profile
- Resource Allocation Profile
- Role Based Authorization Profile
- Sensors Profile
- Service Processor Profile
- Simple Identity Management Profile

For more information, refer to [www.dmtf.org/standards/profiles/](http://www.dmtf.org/standards/profiles/). For updates to this list or information, refer to WS-Management release notes or readme file.

The WS-Management implementation complies with the DMTF Web Services for Management (WS Management) specification version 1.0.0. Known compatible tools that support WS-Management protocol include (but are not limited to) the Microsoft WinRM and OpenWSMan CLI tools.

For specific WS-Management support, see your management application documentation. Additional documentation is available on the Web:

- [www.wbemsolutions.com/ws\\_management.html](http://www.wbemsolutions.com/ws_management.html)
- DMTF WS-Management Specifications:  
[www.dmtf.org/standards/wbem/wsman](http://www.dmtf.org/standards/wbem/wsman)
- DMTF Management Profiles: [www.dmtf.org/standards/profiles/](http://www.dmtf.org/standards/profiles/)

## Other Documents You May Need

In addition to this *User's Guide*, the following documents provide additional information about the setup and operation of the CMC:

- The CMC online help provides information about using the Web interface.
- The *Chassis Management Controller (CMC) Secure Digital (SD) Card Technical Specification* provides minimum BIOS and firmware version, installation and usage information.
- The *Integrated Dell Remote Access Controller Firmware Version 1.0 User's Guide* provides information about installation, configuration and maintenance of the iDRAC on management and managed systems.
- The *Dell OpenManage™ IT Assistant User's Guide* provides information about IT Assistant.
- Documentation specific to your third-party management console application.
- The *Dell OpenManage Server Administrator's User's Guide* provides information about installing and using Server Administrator.
- The *Dell Update Packages User's Guide* provides information about obtaining and using Dell Update Packages as part of your system update strategy.

The following system documents are also available to provide more information about the system in which your CMC is installed:

- The *Product Information Guide* provides important safety and regulatory information. Warranty information may be included within this document or as a separate document.

- The *Rack Installation Guide* and *Rack Installation Instructions* included with your rack solution describe how to install your system into a rack.
- The *Hardware Owner's Manual* provides information about system features and describes how to troubleshoot the system and install or replace system components.
- Systems management software documentation describes the features, requirements, installation, and basic operation of the software.
- Documentation for any components you purchased separately provides information to configure and install these options.
- Updates are sometimes included with the system to describe changes to the system, software, and/or documentation.



**NOTE:** Always read the updates first because they often supersede information in other documents.

- Release notes or readme files may be included to provide last-minute updates to the system or documentation or advanced technical reference material intended for experienced users or technicians.





# Installing and Setting Up the CMC

This section provides information about how to install your CMC hardware, establish access to the CMC, and configure your management environment to use the CMC.

This chapter guides you through the next steps for configuring the CMC:

- Set up initial access to the CMC
- Access the CMC through a network
- Add and configure CMC users
- Update the CMC firmware

Additionally, you can find information about installing and setting up redundant CMC environment at "Understanding the Redundant CMC Environment" on page 51.

## Before You Begin

Prior to setting up your CMC environment, download the latest version of the CMC firmware from the Dell Support website at [support.dell.com](http://support.dell.com).

Then, gather the following items that were included with your system:

- *Dell™ PowerEdge™ Installation and Server Management CD*
- *Dell Systems Management Consoles CD*
- *Dell PowerEdge Service and Diagnostic Utilities CD*
- *Dell PowerEdge Documentation CD*
- *Dell iDRAC Firmware 1.0 User's Guide*

## Installing the CMC Hardware

Because the CMC is preinstalled on your chassis, no installation is required. To get started with the CMC that is installed on your system, see "Installing Remote Access Software on a Management Station" on page 34.

You can install a second CMC to run as a standby to the primary CMC. For more information about a standby CMC, see "Understanding the Redundant CMC Environment" on page 51.

## Installing Remote Access Software on a Management Station

You can access the CMC using the Telnet, Secure Shell (SSH), or serial console utilities provided on your operating system or using the Web interface.

If you want to use remote RACADM from your management station, you will need to install it. Your system includes the Dell OpenManage System Management Software Kit. This kit includes, but is not limited to, the following components:

- *Dell PowerEdge Installation and Server Management* CD — A bootable CD that provides the tools you need to configure your system and install your operating system. This CD contains the latest systems management software products, including Dell OpenManage Server Administrator diagnostics, storage management, and remote access services.
- *Dell Systems Management Consoles* CD — Contains all the latest Dell systems management console products, including Dell OpenManage IT Assistant. Run **Setup** to install the remote RACADM utility for all supported operating systems on your management station.
- *Dell PowerEdge Service and Diagnostic Utilities* CD — Provides the tools you need to configure your system and delivers firmware, diagnostics, and Dell-optimized drivers for your system.
- *Dell PowerEdge Documentation* CD — Helps you stay current with documentation for systems, systems management software products, peripherals, and RAID controllers.

For information about installing Server Administrator software, see your *Server Administrator User's Guide*.

## Installing RACADM on a Linux Management Station

- 1 Log on to the system where you want to install the management station components.
- 2 If necessary, mount the *Dell Systems Management Consoles CD* using the following command or a similar command:

```
mount /media/cdrom
```

- 3 Navigate to the `/linux/rac` directory and execute the following command:

```
rpm -ivh *.rpm
```

For help with the RACADM command, type `racadm help` after issuing the previous commands. For more information about RACADM, see "Using the RACADM Command Line Interface" on page 65.



**NOTE:** When using the RACADM remote capability, you must have write permission on the folders where you are using the RACADM subcommands involving file operations, for example:

```
racadm getconfig -f <file name>
```

or

```
racadm sslcertupload -t 1 -f c:\cert\cert.txt
```

## Uninstalling RACADM From a Linux Management Station

Open a text console on your management station and type:

```
rpm -e <racadm_package_name>
```

where `<racadm_package_name>` is the rpm package that was used to install the RAC software.

For example, if the rpm package name is `srvadmin-racadm5`, then type:

```
rpm -e srvadmin-racadm5
```

## Configuring a Web Browser

You can configure and manage the CMC and the servers and modules installed in the chassis through a Web browser. See "Supported Web Browsers" on page 27 for a list of the Web browsers you can use with the CMC.

Your CMC and the management station where you use your browser must be on the same network, which is called the *management network*. Depending on your security requirements, the management network can be an isolated, highly secure network.

You must ensure that security measures on the management network, such as firewalls and proxy servers, do not prevent your Web browser from accessing the CMC.

Also, be aware that some browser features can interfere with connectivity or performance, especially if the management network does not have a route to the Internet. If your management station is running a Windows operating system, there are Internet Explorer settings that can interfere with connectivity even when you are using a command line interface to access the management network.

## **Proxy Server**

If you have a proxy server for browsing and it does not have access to the management network, you can add the management network addresses to the browser's exception list. This instructs the browser to bypass the proxy server when accessing the management network.

### ***Internet Explorer***

Follow these steps to edit the exception list in Internet Explorer:

- 1** Start Internet Explorer.
- 2** Click **Tools**→ **Internet Options...**, then click **Connections**.
- 3** In the **Local Area Network (LAN) settings** section, click **LAN Settings....**
- 4** In the **Proxy server** section, click **Advanced....**
- 5** In the **Exceptions** section, add the addresses for CMCs and iDRACs on the management network to the semicolon-separated list. You can use DNS names and wildcards in your entries.

### ***Mozilla FireFox***

Follow these steps to edit the exception list in Mozilla FireFox:

- 1** Start FireFox.
- 2** Click **Tools**→ **Options...**→ **Advanced**, then click the **Network** tab.

- 3 Click **Settings...**
- 4 In the **No Proxy for** field, add the addresses for CMCs and iDRACs on the management network to the comma-separated list. You can use DNS names and wildcards in your entries.

### **Microsoft® Phishing Filter**

If the Microsoft Phishing Filter is enabled in Internet Explorer 7 on your management system and your CMC does not have Internet access, you may experience delays of several seconds when accessing the CMC, whether you are using the browser or another interface such as remote RACADM. Follow these steps to disable the phishing filter:

- 1 Start Internet Explorer.
- 2 Click **Tools**→ **Phishing Filter**, and then click **Phishing Filter Settings**.
- 3 Check the **Disable Phishing Filter** checkbox.
- 4 Click **OK**.

### **Certificate Revocation List (CRL) Fetching**

If your CMC has no route to the Internet, you should disable the certificate revocation list (CRL) fetching feature in Internet Explorer. This feature tests whether a server such as the CMC Web server is using a certificate that is on a list of revoked certificates retrieved from the Internet. If the Internet is inaccessible, this feature can cause delays of several seconds when you access the CMC using the browser or with a command line interface such as remote RACADM.

Follow these steps to disable CRL fetching:

- 1 Start Internet Explorer.
- 2 Click **Tools**→ **Internet Options...**, then click **Advanced**.
- 3 Scroll to the Security section and uncheck **Check for publisher's certificate revocation**.
- 4 Click **OK**.

## Downloading Files From CMC With Internet Explorer

When you use Internet Explorer to download files from the CMC you may experience problems when the **Do not save encrypted pages to disk** option is not enabled.

Follow these steps to enable the **Do not save encrypted pages to disk** option:

- 1 Start Internet Explorer.
- 2 Click **Tools**→**Internet Options...**, then click **Advanced**.
- 3 Scroll to the Security section and check **Do not save encrypted pages to disk**.

## Allow Animations in Internet Explorer

When transferring files to and from the Web interface, a file transfer icon spins to show transfer activity. For Internet Explorer, this requires that the browser be configured to play animations, which is the default setting.

Follow these steps to configure Internet Explorer to play animations:

- 1 Start Internet Explorer.
- 2 Click **Tools**→**Internet Options...**, then click **Advanced**.
- 3 Scroll to the Multimedia section and check **Play animations in web pages**.

## Setting Up Initial Access to the CMC

To manage the CMC remotely, connect the CMC to your management network and then configure the CMC network settings. This initial configuration assigns the TCP/IP networking parameters that enable access to the CMC.

The CMC is connected to the management network. All external access to the CMC and iDRACs is accomplished through the CMC. Access to the managed servers, conversely, is accomplished through network connections to I/O modules (IOMs). This allows the application network to be isolated from the management network.

If you have one chassis, connect the CMC, and the standby CMC if present, to the management network. If you have more than one chassis, you can choose between the basic connection, where each CMC is connected to the management network, or a daisy-chained chassis connection, where the

chassis are connected in series and only one is connected to the management network. The basic connection type uses more ports on the management network and provides greater redundancy. The daisy-chain connection type uses fewer ports on the management network but introduces dependencies between CMCs, reducing the redundancy of the system.

### **Basic CMC Network Connection**

For the highest degree of redundancy, connect each CMC to your management network. If a chassis has just one CMC, make one connection on the management network. If the chassis has a redundant CMC in the secondary CMC slot, make two connections to the management network.

Each CMC has two RJ-45 Ethernet ports, labeled "GB1" and "GB2". With basic cabling, you connect the GB1 port to the management network and leave the GB2 port unused.

### **Daisy-chain CMC Network Connection**

If you have multiple chassis in a rack, you can reduce the number of connections to the management network by daisy-chaining up to four chassis together. If each of four chassis contains a redundant CMC, by daisy-chaining you reduce the number of management network connections required from eight to two. If each chassis has only one CMC, you reduce the connections required from four to one.

When daisy-chaining chassis together, GB1 is the "uplink" port and GB2 is the "stacking" port. A GB1 port must connect to the management network or to the GB2 port of the CMC in a chassis that is closer to network. The GB2 port must only receive a connection from a GB1 port further from the chain.

Create separate chains for the CMCs in the primary CMC slot and the second CMC slot.

Figure 2-1 illustrates the arrangement of cables for four daisy-chained chassis, each with CMCs in the primary and secondary slots.

**Figure 2-1. Daisy-chained CMC Network Connection**

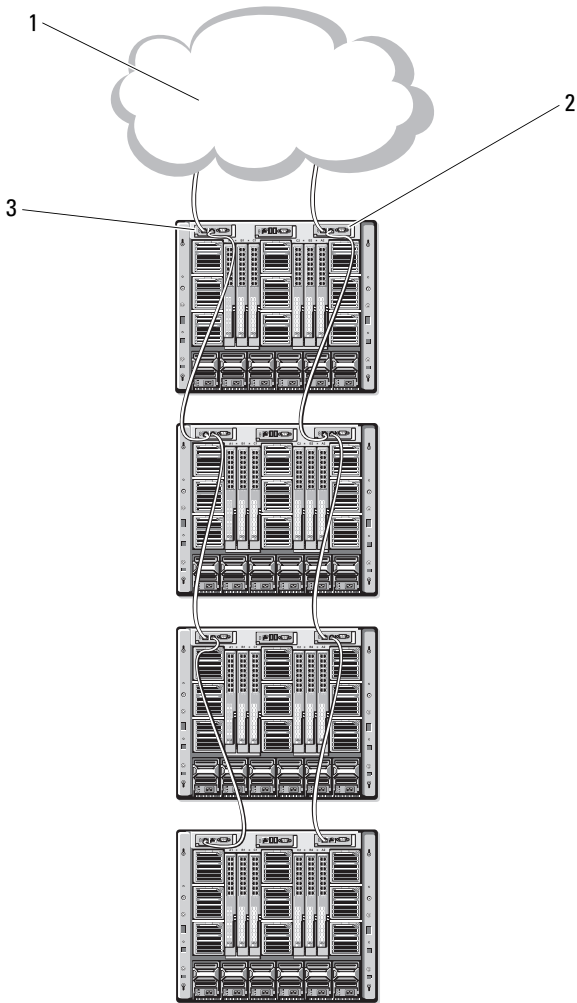

1 management network

2 secondary CMC

3 primary CMC



Follow these steps to daisy-chain up to four chassis:

- 1 Connect the GB1 port of the primary CMC in the first chassis to the management network.
- 2 Connect the GB1 port of the primary CMC in the second chassis to the GB2 port of the primary CMC in the first chassis.
- 3 If you have a third chassis, connect the GB1 port of its primary CMC to the GB2 port of the primary CMC in the second chassis.
- 4 If you have a fourth chassis, connect the GB1 port of its primary CMC to the GB2 port of the third chassis.
- 5 If you have redundant CMCs in the chassis, connect them using the same pattern.



**NOTICE:** The GB2 port on any CMC must never be connected to the management network. It can only be connected to the GB1 port on another chassis. Connecting a GB2 port to the management network can disrupt the network.



**NOTE:** Never connect a primary CMC to a secondary CMC.



**NOTE:** Resetting a CMC whose GB2 port is chained to another CMC can disrupt the network for CMCs later in the chain. The "child" CMCs may log messages indicating that the network link has been lost and they may fail over to their redundant CMCs.

## Configuring the CMC Network



**NOTICE:** Changing your CMC Network settings may disconnect your current network connection.

You can perform the initial network configuration of the CMC before or after the CMC has an IP address. If you configure the CMC's initial network settings *before* you have an IP address, you can use either of the following interfaces:

- The LCD panel on the front of the chassis
- Dell CMC serial console

If you configure initial network settings after the CMC has an IP address, you can use any of the following interfaces:

- Command line interfaces (CLIs) such as a serial console, Telnet, SSH, or the Dell CMC Console via iKVM
- Remote RACADM
- The CMC Web interface

## Configuring Networking Using the LCD Configuration Wizard

**NOTE:** The option to configure the CMC using the LCD Configuration Wizard is available only until the CMC is deployed or the default password is changed. If the password is not changed, the LCD can continue to be used to reconfigure the CMC causing a possible security risk.

The LCD is located on the bottom left corner on the front of the chassis.

Figure 2-2 illustrates the LCD panel.

**Figure 2-2. LCD Display**

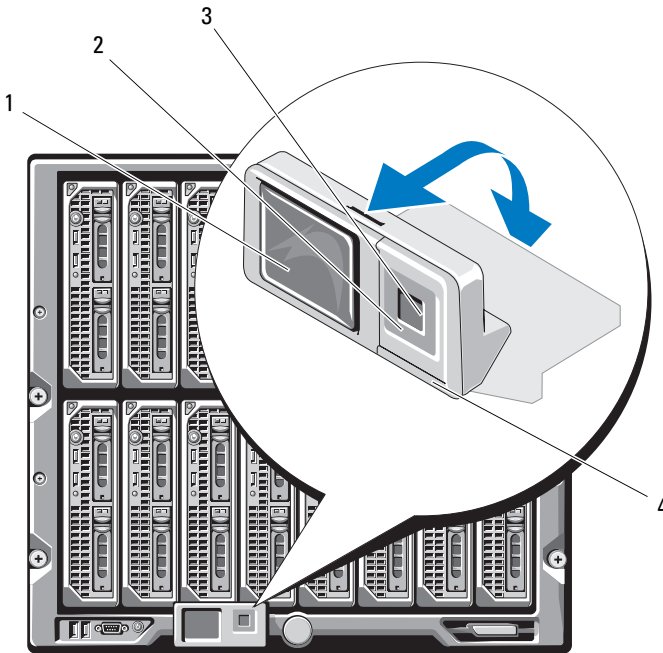

- |   |                            |   |                      |
|---|----------------------------|---|----------------------|
| 1 | LCD screen                 | 2 | scroll buttons (4)   |
| 3 | selection ("check") button | 4 | status indicator LED |

The LCD screen displays menus, icons, pictures, and messages.

A status indicator LED on the LCD panel provides an indication of the overall health of the chassis and its components.

- Solid blue indicates good health.
- Blinking amber indicates that at least one component has a fault condition.
- Blinking blue is an ID signal, used to identify one chassis in a group of chassis.

### **Navigating in the LCD Screen**

The right side of the LCD panel contains five buttons: four arrow buttons (up, down, left, and right) and a center button.

- *To move between screens*, use the right (next) and left (previous) arrow buttons. At any time while using the Configuration Wizard, you can return to a previous screen.
- *To scroll through options on a screen*, use the down and up arrow buttons.
- *To select and save an item on a screen and move to the next screen*, use the center button.

For more information about using the LCD panel see "Using the LCD Panel Interface" on page 383.

### **Using the LCD Configuration Wizard**

- 1** If you have not already done so, press the chassis power button to turn it on.

The LCD screen displays a series of initialization screens as it powers up. When it is ready, the **Language Setup** screen displays.

- 2** Select your language using the down arrow button, and then press the center button.

The **Enclosure** screen displays with the following question: "Configure Enclosure?"

- 3** Press the center button to continue to the **CMC Network Settings** screen.

- 4 Select your network speed (10Mbps, 100Mbps, 1Gbps, or Auto) using the down arrow button.



**NOTE:** The Network Speed setting must match your network configuration for effective network throughput. Setting the Network Speed lower than the speed of your network configuration increases bandwidth consumption and slows network communication. **Determine whether your network supports the above network speeds and set it accordingly.** If your network configuration does not match any of these values, Dell recommends that you use Auto Negotiation (the Auto option) or refer to your network equipment manufacturer.

Press the center button to continue to the next **CMC Network Settings** screen.

- 5 Select the duplex mode (half or full) that matches your network environment.



**NOTE:** The network speed and duplex mode settings are not available if Auto Negotiation is set to On or 1000MB (1Gbps) is selected.



**NOTE:** If auto negotiation is turned on for one device but not the other, then the device using auto negotiation can determine the network speed of the other device, but not the duplex mode; in this case, duplex mode defaults to the half duplex setting during auto negotiation. Such a duplex mismatch will result in a slow network connection.

Press the center button to continue to the next **CMC Network Settings** screen.

- 6 Select the mode in which you want the CMC to obtain the NIC IP addresses:

**Dynamic Host Configuration Protocol (DHCP)**

The CMC retrieves IP configuration (IP address, mask, and gateway) automatically from a DHCP server on your network. The CMC will be assigned a unique IP address allotted over your network. If you have selected the DHCP option, press the center button. The **Register DNS?** screen appears; go to step 7.

## Static

You manually enter the IP address, gateway, and subnet mask in the screens immediately following.

If you have selected the **Static** option, press the center button to continue to the next **CMC Network Settings** screen, then:

- a Set the **Static IP Address** by using the right or left arrow keys to move between positions, and the up and down arrow keys to select a number for each position. When you have finished setting the **Static IP Address**, press the center button to continue.
- b Set the subnet mask, and then press the center button.
- c Set the gateway, and then press the center button. The **Network Summary** screen displays.

The **Network Summary** screen lists the **Static IP Address**, **Subnet Mask**, and **Gateway** settings you entered. Review the settings for accuracy. To correct a setting, use the left arrow key to return to the screen for that setting. After making a correction, press the center button.

- d When you have confirmed the accuracy of the settings you entered, press the center button. The **Register DNS?** screen appears.

## 7 If you selected Static in the previous step, go to step 8.

To register your DNS server's IP address, press the center button to proceed. If you have no DNS, press the right arrow key. The **Configure iDRAC?** screen appears; go to step 8.

Set the **DNS IP Address** using the right or left arrow keys to move between positions, and the up and down arrow keys to select a number for each position. When you have finished setting the DNS IP address, press the center button to continue.

## 8 Indicate whether you want to configure iDRAC:

- **No:** Press the right arrow button. The **IP Summary** screen appears. Skip to step 9.
- **Yes:** Press the center button to proceed.



**NOTE:** You cannot set a static IP address for the iDRAC using the LCD Configuration Wizard. To set a static IP address, use the CMC Web interface or RACADM.

When you have made your selection, press the center button. The **IP Summary** screen displays, listing the IP addresses you provided.

- 9 On the **IP Summary** screen, review for accuracy the IP addresses you provided. To correct a setting, use the left arrow key to return to the screen for that setting. After making a correction, press the center button. If necessary, use the right arrow button to return to the **IP Summary** screen.

When you have confirmed the accuracy of the settings you entered, press the center button. The Configuration Wizard closes and returns you to the **Main Menu** screen.

The CMC is now available on the network. You can access the CMC on the assigned IP address using the Web interface or CLIs such as a serial console, Telnet, and SSH.



**NOTE:** After you have completed network setup through the LCD Configuration Wizard, the Wizard is no longer available.

## Accessing the CMC Through a Network

After you have configured the CMC network settings, you can remotely access the CMC using any of the following interfaces:

- Web interface
- RACADM
- Telnet console
- SSH

Table 2-1 describes each CMC network interface.

**Table 2-1. CMC Interfaces**

<b>Interface</b>	<b>Description</b>
Web interface	Provides remote access to the CMC using a graphical user interface. The Web interface is built into the CMC firmware and is accessed through the NIC interface from a supported Web browser on the management station.  For a list of supported Web browsers, see "Supported Web Browsers" on page 27.
Remote RACADM command line interface	Provides remote access to the CMC from a management station using a command line interface (CLI). Remote RACADM uses the <code>racadm -r</code> option with the CMC's IP address to execute commands on the CMC.
Telnet	Provides command line access to the CMC through the network. The RACADM command line interface and the <code>connect</code> command, which is used for server and IO module debugging, are available from the CMC command line.  <b>NOTE:</b> Telnet is an unsecure protocol that transmits all data—including passwords—in plain text. When transmitting sensitive information, use the SSH interface.
SSH	Provides the same capabilities as Telnet using an encrypted transport layer for greater security.



**NOTE:** The CMC default user name is `root` and the default password is `calvin`.

You can access the CMC and iDRAC Web interfaces through the CMC NIC using a supported Web browser; you can also launch them from the Dell Server Administrator or Dell OpenManage IT Assistant.

For a list of supported Web browsers, see "Supported Web Browsers" on page 27. To access the CMC using a supported Web browser, see "Accessing the CMC Web Interface" on page 87. For information on Dell Server Administrator and Dell OpenManage IT Assistant, see "Installing Remote Access Software on a Management Station" on page 34.

To access the CMC interface using Dell Server Administrator, launch Server Administrator on your management station. From the system tree on the left pane of the Server Administrator home page, click **System** → **Main System Chassis** → **Remote Access Controller**. For more information, see your *Dell Server Administrator User's Guide*.

To access the CMC command line using Telnet or SSH, see "Configuring CMC to Use Command Line Consoles" on page 53.

For information about using RACADM, see "Using the RACADM Command Line Interface" on page 65.

For information about using the **connect** command to connect to servers and IO modules, see "Connecting to Modules With the Connect Command" on page 63.

## Installing or Updating the CMC Firmware

### Downloading the CMC Firmware

Before beginning the firmware update, download the latest firmware version from the Dell Support website at [support.dell.com](http://support.dell.com), and save it to your local system.

The following software components are included with your CMC firmware package:

- Compiled CMC firmware code and data
- Web interface, JPEG, and other user interface data files
- Default configuration files



**NOTE:** During updates of CMC firmware, some or all of the fan units in the chassis will spin at 100%. This is normal.



**NOTE:** The firmware update, by default, retains the current CMC settings. During the update process, you have the option to reset the CMC configuration settings back to the factory default settings.



**NOTE:** If you have redundant CMCs installed in the chassis, it is important to update both to the same firmware version. If the CMCs have different firmware and a failover occurs, unexpected results may occur.



You can use the RACADM `getsysinfo` command (see "getsysinfo" on page 321) or the **Chassis Summary** page (see "Viewing the Current Firmware Versions" on page 138) to view the current firmware versions for the CMCs installed in your chassis.

If you have a standby CMC, it is recommended that you update the firmware in the standby CMC first. When the standby CMC has been updated, swap the CMCs' roles so that the newly updated CMC becomes the primary CMC and the CMC with the older firmware becomes the standby. (See "cmchangeover" on page 289 for help swapping roles.) This allows you to verify that the update succeeded and that the new firmware is working properly before you update the firmware in the second CMC. When both CMCs are updated, you can use the `cmchangeover` command to restore the CMCs to their previous roles.

### Updating CMC Firmware Using the Web Interface

For instructions on using the Web interface to update CMC firmware, see "Updating CMC and iKVM Firmware" on page 138.

### Updating the CMC Firmware Using RACADM

For instructions on using the RACADM `fwupdate` subcommand to update CMC firmware, see "fwupdate" on page 296.

## Configuring CMC Properties

You can configure CMC properties such as power budgeting, network settings, users, and SNMP and e-mail alerts using the Web interface or RACADM.

For more information about using the Web interface, see "Accessing the CMC Web Interface" on page 87. For more information about using RACADM, see "Using the RACADM Command Line Interface" on page 65.

You can configure the CMC using one of the following configuration tools:

- The CMC Web interface. For more information, see "Using the CMC Web Interface" on page 87.
- A local RACADM command line interface (CLI). For more information, see "Using the RACADM Command Line Interface" on page 65.



**NOTICE:** Using more than one CMC configuration tool at the same time may generate unexpected results.

## Configuring Power Budgeting

The CMC offers a power budgeting service that allows you to configure power budget, redundancy, and dynamic power for the chassis.

The chassis ships with either three or six power supply units (PSUs). If your chassis has only three PSUs, you can add up to three more. The power management service enables optimization of power consumption and re-allocation of power to different modules based on demand.

For more information about CMC power management, see "Power Management" on page 197.

For instructions on configuring power budgeting and other power settings using the Web interface, see "Configuring Power Budgeting" on page 137.

## Configuring CMC Network Settings



**NOTE:** Changing your CMC network settings may disconnect your current network connection.

You can configure the CMC network settings using one of the following tools:

- RACADM — see "Configuring Multiple CMCs in Multiple Chassis" on page 80



**NOTE:** If you are deploying the CMC in a Linux environment, see "Installing RACADM on a Linux Management Station" on page 35.

- Web interface — see "Configuring CMC Network Properties" on page 100

## Adding and Configuring Users

You can add and configure CMC users using either RACADM or the CMC Web interface. You can also utilize Microsoft<sup>®</sup> Active Directory<sup>®</sup> to manage users.

For instructions on adding and configuring users using RACADM, see "Adding a CMC User" on page 78. For instructions on adding and configuring users using the Web interface, see "Adding and Configuring CMC Users" on page 107.

For instructions on using Active Directory with your CMC, see "Using the CMC With Microsoft Active Directory" on page 167.

## Adding SNMP and E-mail Alerts

You can configure the CMC to generate SNMP and/or e-mail alerts when certain chassis events occur. For more information, see "Configuring SNMP Alerts" on page 260 and "Configuring E-mail Alerts" on page 265.

## Understanding the Redundant CMC Environment

You can install a standby CMC that takes over if your primary CMC fails.

Failovers can occur when you:

- Run the RACADM `cmchangeover` command. (See "cmchangeover" on page 289.)
- Run the RACADM `racreset` command on the active CMC. (See "racreset" on page 329.)
- Remove the network cable from the active CMC
- Remove the active CMC from the chassis
- Initiate a CMC firmware flash on the active CMC
- Primary CMC is no longer functional



**NOTE:** In the event of CMC failover, all iDRAC connections and all active CMC sessions will be lost. Users who lose sessions must reconnect to the new primary CMC.

### About the Standby CMC

The standby CMC is identical to and is maintained as a mirror of the active CMC. The active and standby CMCs must both be installed with the same firmware revision. If the firmware revisions differ, the system will report as redundancy degraded.

The standby CMC assumes the same settings and properties of the primary CMC. You must maintain the same firmware version on both CMCs, but you do not need to duplicate configuration settings on the standby CMC.



**NOTE:** For information about installing a standby CMC, see the *Hardware Owner's Manual*. For instructions on installing the CMC firmware on your standby CMC, follow the instructions in "Installing or Updating the CMC Firmware" on page 48.

## Primary CMC Election Process

There is no difference between the two CMC slots; that is, slot does not dictate precedence. Instead, the CMC that is installed or booted first assumes the role of the active CMC. If AC power is applied with two CMCs installed, the CMC installed in CMC chassis slot 1 (the left) normally assumes the active role. The active CMC is indicated by the blue LED.

If two CMCs are inserted into a chassis that is already powered on, automatic active/standby negotiation can take up to two minutes. Normal chassis operation resumes when the negotiation is complete.

## Planning Deployment of Redundant CMCs

When planning CMC deployment and chassis cabling, it is recommended that you choose the left CMC to act as the primary and the right CMC to act as secondary, and then maintain those roles. This is best practice because it is the default arrangement when the chassis is powered on and redundancy is increased when all of the primary CMCs in daisy-chained chassis are cabled together. When a failover occurs and a CMC in the right slot becomes primary, use the `RACADM cmchangeover` command to reset the CMC in the left slot to primary.

## Obtaining Health Status of Redundant CMC

You can view the health status of the standby CMC in the Web interface. For more information about accessing CMC health status in the Web interface, see "Viewing Chassis and Component Health Status" on page 89.

# Configuring CMC to Use Command Line Consoles

This section provides information about the CMC command line console (or *serial/Telnet/Secure Shell console*) features, and explains how to set up your system so you can perform systems management actions through the console. For information on using the RACADM commands in CMC via the command line console, see "Using the RACADM Command Line Interface" on page 65.

## Command Line Console Features on the CMC

The CMC supports the following serial and Telnet console features:

- One serial client connection and up to four simultaneous Telnet client connections
- Up to four simultaneous Secure Shell (SSH) client connections
- RACADM command support
- Built-in **connect** command for debugging servers and I/O modules
- Command Line editing and history
- Session timeout control on all console interfaces

## Using a Telnet Console With the CMC

The managed system provides access between the CMC and the Telnet console to enable you to turn on, turn off, or reset the managed system, and access logs.

Up to four Telnet client systems and four SSH clients may connect at any given time. The management station connection to the managed system Telnet console requires management station terminal emulation software. For more information, see "Configuring Terminal Emulation Software" on page 55.

## Using SSH With the CMC

SSH is a command line session that includes the same capabilities as a Telnet session, but with session negotiation and encryption to improve security. The CMC supports SSH version 2 with password authentication. SSH is enabled on the CMC by default.

 **NOTE:** The CMC does not support SSH version 1.

When an error occurs during the login procedure, the SSH client issues an error message. The message text is dependent on the client and is not controlled by the CMC.

 **NOTE:** OpenSSH should be run from a VT100 or ANSI terminal emulator on Windows. Running OpenSSH at the Windows command prompt does not provide full functionality (that is, some keys do not respond and no graphics are displayed). For Linux, run SSH Client Services to connect to CMC with any shell.

Four simultaneous SSH sessions are supported at any given time. The session timeout is controlled by the `cfgSsnMgtSshIdleTimeout` property (see "RACADM Subcommands" on page 285) or from the **Services Management** page in the Web interface (see "Configuring Services" on page 130).

### Enabling SSH on the CMC

SSH is enabled by default. If SSH is disabled, then you can enable it using any other supported interface.

For instructions on enabling SSH connections on the CMC using RACADM, see "config" on page 290 and "cfgSerial" on page 360. For instructions on enabling SSH connections on the CMC using the Web interface, see "Configuring Services" on page 130.

### Changing the SSH Port

To change the SSH port, use the following command:

```
racadm config -g cfgRacTuning -o cfgRacTuneSshPort  
<port number>
```

For more information about `cfgSerialSshEnable` and `cfgRacTuneSshPort` properties, see "CMC Property Database Group and Object Definitions" on page 347.

The CMC SSH implementation supports multiple cryptography schemes, as shown in Table 3-1.

**Table 3-1. Cryptography Schemes**

<b>Scheme Type</b>	<b>Scheme</b>
Asymmetric Cryptography	Diffie-Hellman DSA/DSS 512–1024 (random) bits per NIST specification
Symmetric Cryptography	<ul style="list-style-type: none"> <li>• AES256-CBC</li> <li>• RIJNDAEL256-CBC</li> <li>• AES192-CBC</li> <li>• RIJNDAEL192-CBC</li> <li>• AES128-CBC</li> <li>• RIJNDAEL128-CBC</li> <li>• BLOWFISH-128-CBC</li> <li>• 3DES-192-CBC</li> <li>• ARCFOUR-128</li> </ul>
Message Integrity	<ul style="list-style-type: none"> <li>• HMAC-SHA1-160</li> <li>• HMAC-SHA1-96</li> <li>• HMAC-MD5-128</li> <li>• HMAC-MD5-96</li> </ul>
Authentication	Password

### **Enabling the Front Panel to iKVM Connection**

For information and instructions on using the iKVM front panel ports, see "Enabling or Disabling the Front Panel" on page 243.

## **Configuring Terminal Emulation Software**

Your CMC supports a serial or Telnet text console from a management station running one of the following types of terminal emulation software:

- Linux Minicom in an Xterm
- Hilgraeve’s HyperTerminal Private Edition (version 6.3)

- Linux Telnet in an Xterm
- Microsoft® Telnet

Perform the steps in the following subsections to configure your type of terminal software. If you are using Microsoft Telnet, configuration is not required.

## Configuring Linux Minicom for Serial Console Emulation

Minicom is a serial port access utility for Linux. The following steps are valid for configuring Minicom version 2.0. Other Minicom versions may differ slightly but require the same basic settings. Use the information in "Required Minicom Settings for Serial Console Emulation" on page 57 to configure other versions of Minicom.

### Configuring Minicom Version 2.0 for Serial Console Emulation



**NOTE:** To ensure that the text displays properly, Dell recommends that you use an Xterm window to display the Telnet console instead of the default console provided by the Linux installation.

- 1 To start a new Xterm session, type `xterm &` at the command prompt.
- 2 In the Xterm window, move your mouse arrow to the lower right-hand corner of the window and resize the window to 80 x 25.
- 3 If you do not have a Minicom configuration file, go to the next step. If you have a Minicom configuration file, type `minicom <Minicom config file name>` and skip to step 17.
- 4 At the Xterm command prompt, type `minicom -s`.
- 5 Select **Serial Port Setup** and press `<Enter>`.
- 6 Press `<a>`, and then select the appropriate serial device (for example, `/dev/ttyS0`).
- 7 Press `<e>`, and then set the **Bps/Par/Bits** option to **115200 8N1**.
- 8 Press `<f>`, and then set **Hardware Flow Control** to **Yes** and set **Software Flow Control** to **No**.  
To exit the **Serial Port Setup** menu, press `<Enter>`.
- 9 Select **Modem and Dialing** and press `<Enter>`.



- 10** In the **Modem Dialing and Parameter Setup** menu, press <Backspace> to clear the **init**, **reset**, **connect**, and **hangup** settings so that they are blank.
- 11** Press <Enter> to save each blank value.
- 12** When all specified fields are clear, press <Enter> to exit the **Modem Dialing and Parameter Setup** menu.
- 13** Select **Save setup as config\_name** and press <Enter>.
- 14** Select **Exit From Minicom** and press <Enter>.
- 15** At the command shell prompt, type `minicom <Minicom config file name>`.  
To expand the Minicom window to 80 x 25, drag the corner of the window.
- 16** Press <Ctrl+a>, <z>, <x> to exit Minicom.

Ensure that the Minicom window displays a command prompt such as `[idrac@root]#`. When the command prompt appears, your connection is successful and you are ready to connect to the managed system console using the **connect** serial command.

### Required Minicom Settings for Serial Console Emulation

Use Table 3-2 to configure any version of Minicom.

**Table 3-2. Minicom Settings for Serial Console Emulation**

Setting Description	Required Setting
Bps/Par/Bits	115200 8N1
Hardware flow control	Yes
Software flow control	No
Terminal emulation	ANSI
Modem dialing and parameter settings	Clear the <b>init</b> , <b>reset</b> , <b>connect</b> , and <b>hangup</b> settings so that they are blank
Window size	80 x 25 (to resize, drag the corner of the window)

## Running Telnet Using Windows XP or Windows 2003

If your management station is running Windows XP or Windows 2003, you may experience an issue with the characters in a CMC Telnet session. This issue may occur as a frozen login where the return key does not respond and the password prompt does not appear.

To fix this issue, download hotfix 824810 from the Microsoft Support website at [support.microsoft.com](http://support.microsoft.com). See Microsoft Knowledge Base article 824810 for more information.

## Configuring Linux for Serial Console Redirection During Boot

The following steps are specific to the Linux GRand Unified Bootloader (GRUB). Similar changes would be necessary for using a different boot loader.



**NOTE:** When you configure the client VT100 emulation window, set the window or application that is displaying the redirected console to 25 rows x 80 columns to ensure proper text display; otherwise, some text screens may be garbled.

Edit the `/etc/grub.conf` file as follows:

- 1 Locate the general setting sections in the file and add the following two new lines:  

```
serial --unit=1 --speed=57600  
terminal --timeout=10 serial
```
- 2 Append two options to the kernel line:  

```
kernel..... console=ttyS1,57600
```
- 3 If the `/etc/grub.conf` contains a `splashimage` directive, comment it out.

The following example shows the changes described in this procedure.

```
# grub.conf generated by anaconda  
#  
# Note that you do not have to rerun grub after making  
# changes  
# to this file  
# NOTICE: You do not have a /boot partition. This  
# means that  
#         all kernel and initrd paths are relative to  
#         /, e.g.  
#         root (hd0,0)
```

```

#          kernel /boot/vmlinuz-version ro root=
/dev/sda1
#          initrd /boot/initrd-version.img
#
#boot=/dev/sda
default=0
timeout=10
#splashimage=(hd0,2)/grub/splash.xpm.gz

serial --unit=1 --speed=57600
terminal --timeout=10 serial

title Red Hat Linux Advanced Server (2.4.9-e.3smp)
    root (hd0,0)
    kernel /boot/vmlinuz-2.4.9-e.3smp ro root=
/dev/sda1 hda=ide-scsi console=ttyS0 console=
ttyS1,57600
    initrd /boot/initrd-2.4.9-e.3smp.img
title Red Hat Linux Advanced Server-up (2.4.9-e.3)
    root (hd0,00)
    kernel /boot/vmlinuz-2.4.9-e.3 ro root=/dev/sda1 s
    initrd /boot/initrd-2.4.9-e.3.im

```

When you edit the `/etc/grub.conf` file, use the following guidelines:

- Disable GRUB's graphical interface and use the text-based interface; otherwise, the GRUB screen will not be displayed in console redirection. To disable the graphical interface, comment out the line starting with `splashimage`.
- To start multiple GRUB options to start console sessions through the serial connection, add the following line to all options:

```
console=ttyS1,57600
```

The example shows `console=ttyS1,57600` added to only the first option.

## Enabling Login to the Console After Boot

Edit the file `/etc/inittab`, as follows:

- Add a new line to configure `agetty` on the COM2 serial port:  
`co:2345:respawn:/sbin/agetty -h -L 57600 ttyS1  
ansi`

The following example shows the file with the new line.

```
#
# inittab This file describes how the INIT process
#         should set up the system in a certain
#         run-level.
#
# Author:  Miquel van Smoorenburg
#         Modified for RHS Linux by Marc Ewing and
#         Donnie Barnes
#
# Default runlevel. The runlevels used by RHS are:
#  0 - halt (Do NOT set initdefault to this)
#  1 - Single user mode
#  2 - Multiuser, without NFS (The same as 3, if you
#     do not have networking)
#  3 - Full multiuser mode
#  4 - unused
#  5 - X11
#  6 - reboot (Do NOT set initdefault to this)
#
id:3:initdefault:

# System initialization.
si::sysinit:/etc/rc.d/rc.sysinit

10:0:wait:/etc/rc.d/rc 0
11:1:wait:/etc/rc.d/rc 1
12:2:wait:/etc/rc.d/rc 2
13:3:wait:/etc/rc.d/rc 3
```

```

14:4:wait:/etc/rc.d/rc 4
15:5:wait:/etc/rc.d/rc 5
16:6:wait:/etc/rc.d/rc 6

# Things to run in every runlevel.
ud::once:/sbin/update

# Trap CTRL-ALT-DELETE
ca::ctrlaltdel:/sbin/shutdown -t3 -r now

# When our UPS tells us power has failed, assume we
# have a few
# minutes of power left. Schedule a shutdown for 2
# minutes from now.
# This does, of course, assume you have power
# installed and your
# UPS is connected and working correctly.
pf::powerfail:/sbin/shutdown -f -h +2 "Power Failure;
System Shutting Down"
# If power was restored before the shutdown kicked in,
# cancel it.
pr:12345:powerokwait:/sbin/shutdown -c "Power
Restored; Shutdown Cancelled"

# Run gettys in standard runlevels
co:2345:respawn:/sbin/agetty -h -L 57600 ttyS1 ansi
1:2345:respawn:/sbin/mingetty tty1
2:2345:respawn:/sbin/mingetty tty2
3:2345:respawn:/sbin/mingetty tty3
4:2345:respawn:/sbin/mingetty tty4
5:2345:respawn:/sbin/mingetty tty5
6:2345:respawn:/sbin/mingetty tty6

# Run xdm in runlevel 5
# xdm is now a separate service
x:5:respawn:/etc/X11/prefdm -nodaemon

```

Edit the file `/etc/securetty`, as follows:

- Add a new line, with the name of the serial tty for COM2:  
`ttys1`

The following example shows a sample file with the new line.

```
vc/1
vc/2
vc/3
vc/4
vc/5
vc/6
vc/7
vc/8
vc/9
vc/10
vc/11
tty1
tty2
tty3
tty4
tty5
tty6
tty7
tty8
tty9
tty10
tty11
ttys1
```

# Using a Serial or Telnet Console

When you connect to the CMC command line, you are able to enter these commands:

**Table 3-3. CMC Command Line Commands**

Command	Description
racadm	RACADM commands begin with the keyword <b>racadm</b> and are followed by a subcommand, such as <b>getconfig</b> , <b>serveraction</b> , or <b>getsensorinfo</b> . See "Using the RACADM Command Line Interface" on page 65 for details on using RACADM.
connect	Connects to a server or I/O module for debugging. See "Connecting to Modules With the Connect Command" on page 63 for help using the <b>connect</b> command.
exit, logout, and quit	These commands all perform the same action: they end the current session and return to a login prompt.

## Connecting to Modules With the Connect Command

While in a command line connection, the CMC supports the **connect** command to establish a serial connection to server and IOM modules. Connection to server modules is only provided for operating system debugging. To connect to server modules to use operating system remote consoles, you should use the iDRAC Web interface console redirection feature or the iDRAC Serial Over LAN (SOL) functionality.



**NOTICE:** When executed from the CMC serial console, the **connect -b** option stays connected until the CMC resets. This connection is a potential security risk.



**NOTE:** The **connect** command provides the **-b** (binary) option. The **-b** option passes raw binary data, and **cfgSerialConsoleQuitKey** is not used. Additionally, when connecting to a server using the CMC serial console, transitions in the DTR signal (for example, if the serial cable is removed to connect a debugger) do not cause a logout.



**NOTE:** If an IOM does not support console redirection, the **connect** command will display an empty console. In that case, to return to the CMC console, type the Escape sequence. The default console escape sequence is **<Ctrl>\**.

There are up to six IOMs on the managed system. To connect to an IOM, type:

```
connect switch-n
```

where *n* is an IOM number 1 through 6.

IOMs are labeled A1, A2, B1, B2, C1, and C2. (See Table 10-1 for an illustration of the placement of IOMs in the chassis.) When you reference the IOMs in the **connect** command, the IOMs are mapped to switches as shown in Table 3-4.

**Table 3-4. Mapping I/O Modules to Switches**

I/O Module Label	Switch
A1	switch-1
A2	switch-2
B1	switch-3
B2	switch-4
C1	switch-5
C2	switch-6



**NOTE:** There can only be one IOM connection per chassis at a time.



**NOTE:** You cannot connect to passthroughs from the serial console.

To connect to a managed server for debugging, use the command *connect server-*n**, where *-n* is the slot number of the server you wish to debug. When you connect to a server, binary communication is assumed and the escape character is disabled. If the iDRAC is not available, you will see a `No route to host` error message. Ensure that your server is inserted properly and the iDRAC has had time to complete the boot routine.

For details on how to connect through a serial connection, see "Configuring CMC to Use Command Line Consoles" on page 53.



# Using the RACADM Command Line Interface

RACADM provides a set of commands that allow you to configure and manage the CMC through a text-based interface. RACADM can be accessed using a Telnet/SSH or serial connection, using the Dell CMC console on the iKVM, or remotely using the RACADM command line interface installed on a management station.

The RACADM interface is classified as "local" or "remote," depending on the location of the `racadm` executable program you are using:



**NOTE:** Remote RACADM is included on the *Dell™ Systems Management Consoles* CD and is installed on a management station.

- Remote RACADM — you execute RACADM commands on a management station with the `-r` option and the DNS name or IP address of the CMC.
- Local RACADM — you log into the CMC using Telnet, SSH, a serial connection, or the iKVM. With local RACADM, you are executing the RACADM implementation that is part of the CMC firmware.

You can use remote RACADM commands in scripts to configure multiple CMCs. The CMC does not have support for scripting, so you cannot execute scripts directly on the CMC. For more information about configuring multiple CMCs, see "Configuring Multiple CMCs in Multiple Chassis" on page 80.

This section provides the following information:

- Using the `serial` and `racadm` commands. See "Using a Serial or Telnet Console" on page 66 or "Using RACADM" on page 66.
- Configuring your CMC through RACADM. See "Using RACADM to Configure the CMC" on page 72.
- Using the RACADM configuration file to configure multiple CMCs. See "Configuring Multiple CMCs in Multiple Chassis" on page 80.

## Using a Serial or Telnet Console

You can log in to the CMC either through a serial or Telnet/SSH connection, or through Dell CMC console on iKVM. To configure the CMC for serial or remote access, see "Configuring CMC to Use Command Line Consoles" on page 53. Commonly used subcommand options are listed in Table 4-2. A complete list of RACADM subcommands is listed in "RACADM Subcommands" on page 285.

### Logging in to the CMC

After you have configured your management station terminal emulator software and managed node BIOS, perform the following steps to log into the CMC:

- 1 Connect to the CMC using your management station terminal emulation software.
- 2 Type your CMC user name and password, and then press <Enter>. You are logged into the CMC.

### Starting a Text Console

You can log in to the CMC using Telnet or SSH through a network, serial port, or a Dell CMC console through the iKVM. Open a Telnet or SSH session, connect and log on to the CMC.

For information about connecting to the CMC through iKVM, see "Using the iKVM Module" on page 225.

## Using RACADM

RACADM subcommands can be run remotely from the serial or Telnet console command prompt or through a normal command prompt.

Use RACADM subcommands to configure CMC properties and perform remote management tasks. To display a list of RACADM subcommands, type:

```
racadm help
```

When run without options or subcommands, RACADM displays syntax information and instructions on how to access subcommands and help. To list syntax and command-line options for individual subcommands, type:

```
racadm help <subcommand>
```

## RACADM Subcommands

Table 4-1 provides a brief list of common subcommands used in RACADM. For a complete list of RACADM subcommands, including syntax and valid entries, see "RACADM Subcommands" on page 285.



**NOTE:** The connect, exit, quit, and logout commands are built-in CMC commands, not RACADM commands. They cannot be used with remote RACADM. See "Using a Serial or Telnet Console" on page 63 for information about using these commands.

When entering a RACADM subcommand, prefix the command with racadm. For example:

```
racadm help
```

**Table 4-1. RACADM Subcommands**

Command	Description
help	Lists CMC subcommand descriptions.
help <subcommand>	Lists usage summary for the specified subcommand.
?	Lists CMC subcommand descriptions.
? <subcommand>	Lists usage summary for the specified subcommand.
arp	Displays the contents of the ARP table. ARP table entries may not be added or deleted.
chassisaction	Executes power-up, power-down, reset, and power-cycle on the chassis, switch, and KVM.
clrraclog	Clears the CMC log and creates a single entry indicating the user and time that the log was cleared.
clrsel	Clears the System Event Log entries.
cmchangeover	Changes the state of the CMC from active to standby, or vice versa, in redundant CMC environments.
config	Configures the CMC.
deploy	Deploys a server by specifying required properties.

**Table 4-1. RACADM Subcommands (continued)**

<b>Command</b>	<b>Description</b>
feature	Displays active features and feature deactivation.
featurecard	Displays feature card status information.
fwupdate	Executes or displays status on system firmware updates.
getassettag	Displays the asset tag for the chassis.
getchassisname	Displays the name of the chassis.
getconfig	Displays the current CMC configuration properties.
getdcinfo	Displays general I/O module and daughter card misconfiguration information.
getflexaddr	Displays the FlexAddress enabled/disabled status on a per slot/fabric basis. If used with the <code>-i</code> option, the command displays WWN and MAC address for a particular slot.
getioinfo	Displays general I/O module information.
getkvminfo	Displays information about the iKVM.
getled	Displays the LED settings on a module.
getmacaddress	Displays a server's MAC address.
getmodinfo	Displays module configuration and status information.
getniccfg	Displays the current IP configuration for the controller.
getpbinfo	Displays power budget status information.
getraclog	Displays the CMC log.
getrctime	Displays the CMC time.
getredundancymode	Displays the redundancy mode of the CMC.
getsel	Displays the system event log (hardware log).
getsensorinfo	Displays information about system sensors.
getslotname	Displays the name of a slot in the chassis.
getssninfo	Displays information about active sessions.
getsvctag	Displays service tags.
getsysinfo	Displays general CMC and system information.

**Table 4-1. RACADM Subcommands (continued)**

<b>Command</b>	<b>Description</b>
gettracelog (Dell internal use only)	Displays the CMCTrace log. If used with the <code>-i</code> option, the command displays the number of entries in the CMC trace log.
ifconfig	Displays the current CMC IP configuration.
netstat	Displays the routing table and the current connections.
ping	Verifies that the destination IP address is reachable from the CMC with the current routing-table contents.
racdump	Dumps CMC status and state information for debug.
racreset	Resets the CMC.
racresetcfg	Resets the CMC to the default configuration.
serveraction	Performs power management operations on the managed system.
setassettag	Sets the asset tag for the chassis.
setchassisname	Sets the name of the chassis.
setflexaddr	Enables/disables FlexAddress on a particular slot/fabric, when the FlexAddress feature is activated on the chassis
setled	Sets the LED settings on a module.
setniccfg	Sets the IP configuration for the controller.
setractime	Sets the CMC time.
setslotname	Sets the name of a slot in the chassis.
setsysinfo	Sets the name and location of the chassis.
sslcertdownload	Downloads a certificate authority-signed certificate.
sslcertupload	Uploads a certificate authority-signed certificate or server certificate to the CMC.
sslcertview	Views a certificate authority-signed certificate or server certificate in the CMC.
sslsrgen	Generates and downloads the SSL CSR.
testemail	Forces the CMC to send an e-mail over the CMC NIC.
testtrap	Forces the CMC to send an SNMP over the CMC NIC.

## Accessing RACADM Remotely

Table 4-2 lists the options for the remote RACADM subcommands.

**Table 4-2. Remote RACADM Subcommand Options**

Option	Description
<code>-r &lt;racIpAddr&gt;</code>	Specifies the controller's remote IP address.
<code>-r &lt;racIpAddr&gt;:&lt;port&gt;</code>	Use <i>&lt;port number&gt;</i> if the CMC port number is not the default port (443)
<code>-i</code>	Instructs RACADM to interactively query the user for user name and password.
<code>-u &lt;usrName&gt;</code>	Specifies the user name that is used to authenticate the command transaction. If the <code>-u</code> option is used, the <code>-p</code> option must be used, and the <code>-i</code> option (interactive) is not allowed.
<code>-p &lt;password&gt;</code>	Specifies the password used to authenticate the command transaction. If the <code>-p</code> option is used, the <code>-i</code> option is not allowed.

To access RACADM remotely, type the following commands:

```
racadm -r <CMC IP address> -u <username> -p <password>  
<subcommand> <subcommand options>
```

```
racadm -i -r <CMC IP address> <subcommand> <subcommand  
options>
```



**NOTE:** The `-i` option instructs RACADM to interactively prompt for user name and password. Without the `-i` option, you must provide the user name and password in the command using the `-u` and `-p` options.

For example:

```
racadm -r 192.168.0.120 -u root -p calvin getsysinfo  
racadm -i -r 192.168.0.120 getsysinfo
```

If the HTTPS port number of the CMC has been changed to a custom port other than the default port (443), the following syntax must be used:

```
racadm -r <CMC IP address>:<port> -u <username> -p  
<password> <subcommand> <subcommand options>
```

```
racadm -i -r <CMC IP address>:<port> <subcommand>  
<subcommand options>
```

## Enabling and Disabling the RACADM Remote Capability



**NOTE:** Dell recommends that you run these commands at the chassis.

The RACADM remote capability on the CMC is enabled by default. In the following commands, **-g** specifies the configuration group the object belongs to, and **-o** specifies the configuration object to configure.

To disable the RACADM remote capability, type:

```
racadm config -g cfgRacTuning -o  
cfgRacTuneRemoteRacadmEnable 0
```

To re-enable RACADM remote capability, type:

```
racadm config -g cfgRacTuning -o  
cfgRacTuneRemoteRacadmEnable 1
```

## Using RACADM Remotely



**NOTE:** Configure the IP address on your CMC before using the RACADM remote capability. For more information about setting up your CMC, see "Installing and Setting Up the CMC" on page 33.

The RACADM console's remote option (**-r**) allows you to connect to the managed system and execute RACADM subcommands from a remote console or management station. To use the remote capability, you need a valid user name (**-u** option) and password (**-p** option), and the CMC IP address.

Before you try to access RACADM remotely, confirm that you have permissions to do so. To display your user privileges, type:

```
racadm getconfig -g cfguseradmin -i n
```

where *n* is your user ID (1–16).

If you do not know your user ID, try different values for *n*.

 **NOTE:** The RACADM remote capability is supported only on management stations through a supported browser. See "Supported Web Browsers" on page 27 for more information.

 **NOTE:** When using the RACADM remote capability, you must have write permissions on the folders where you are using the RACADM subcommands involving file operations. For example:

```
racadm getconfig -f <file name> -r <IP address>
```

or

```
racadm sslcertupload -t 1 -f c:\cert\cert.txt
```

## RACADM Error Messages

For information about RACADM CLI error messages, see "Troubleshooting" on page 86.

## Using RACADM to Configure the CMC

 **NOTE:** In order to configure CMC the first time. You must be logged in as user `root` to execute RACADM commands on a remote system. Another user can be created that will give him or her the permission to configure the CMC.

The CMC Web interface is the quickest way to configure the CMC (see "Using the CMC Web Interface" on page 87). However, if you prefer CLI or script configuration or need to configure multiple CMCs, use RACADM, which is installed with the CMC agents on the management station.

## Configuring CMC Network Properties

### Setting Up Initial Access to the CMC

Before you can begin configuring the CMC, you must first configure the CMC network settings to allow the CMC to be managed remotely. This initial configuration assigns the TCP/IP networking parameters that enable access to the CMC.



This section explains how to perform the initial CMC network configuration using RACADM commands. All of the configuration described in this section can be performed using the front panel LCD. See "Configuring Networking Using the LCD Configuration Wizard" on page 42.

 **NOTICE:** Changing your CMC Network settings may disconnect your current network connection.

For more information about network subcommands, see "RACADM Subcommands" on page 285 and "CMC Property Database Group and Object Definitions" on page 347.

 **NOTE:** You must have **Chassis Configuration Administrator** privilege to set up CMC network settings.

By default, the CMC requests and obtains a CMC IP address from the Dynamic Host Configuration Protocol (DHCP) server automatically.

You can disable this feature and specify static CMC IP address, gateway, and subnet mask.

To disable DHCP and specify static CMC IP address, gateway, and subnet mask, type:

```
racadm config -g cfgLanNetworking -o cfgNicUseDHCP 0
racadm config -g cfgLanNetworking -o cfgNicIpAddress
<static IP address>
```

```
racadm config -g cfgLanNetworking -o cfgNicGateway
<static gateway>
```

```
racadm config -g cfgLanNetworking -o cfgNicNetmask
<static subnet mask>
```

## Viewing Current Network Settings

To view a summary of NIC, DHCP, network speed, and duplex settings, type:

```
racadm getniccfg
```

or

```
racadm getconfig -g cfgCurrentLanNetworking
```

To view IP address and DHCP, MAC address, and DNS information for the chassis, type:

```
racadm getsysinfo
```

## Configuring the Network LAN Settings



**NOTE:** To perform the following steps, you must have **Chassis Configuration Administrator** privilege.



**NOTE:** The LAN settings, such as community string and SMTP server IP address, affect both the CMC and the external settings of the chassis.



**NOTE:** If you have two CMCs (primary and standby) on the chassis, and they are both connected to the network, the standby CMC automatically assumes the network settings in the event of failover of the primary CMC.

### Enabling the CMC NIC

To enable the CMC NIC, type:

```
racadm config -g cfgLanNetworking -o cfgNicEnable 1
```

### Enabling or Disabling DHCP for the NIC Address

When enabled, the CMC's DHCP for NIC address feature requests and obtains an IP address from the Dynamic Host Configuration Protocol (DHCP) server automatically. This feature is enabled by default.

You can disable the DHCP for NIC address feature and specify a static IP address, subnet mask, and gateway. For instructions, see "Setting Up Initial Access to the CMC" on page 72.



**NOTE:** If you disable the DHCP for NIC address feature and then re-enable it later, the static IP address, subnet mask, and gateway settings are lost.

### Enabling or Disabling DHCP for DNS IP Addresses

By default, the CMC's DHCP for DNS address feature is disabled. When enabled, this feature obtains the primary and secondary DNS server addresses from the DHCP server. Using this feature, you do not have to configure static DNS server IP addresses.

To disable the DHCP for DNS address feature and specify static preferred and alternate DNS server addresses, type:

```
racadm config -g cfgLanNetworking -o  
cfgDNSServersFromDHCP
```

## Setting Static DNS IP addresses



**NOTE:** These settings are not valid unless the DHCP for DNS address feature is disabled.

To set the preferred DNS IP address, type:

```
racadm config -g cfgLanNetworking -o cfgDNSServer1  
<IP-address>
```

To set the secondary DNS IP address, type:

```
racadm config -g cfgLanNetworking -o cfgDNSServer2  
<IP-address>
```

## Configuring DNS Settings

- **CMC Registration.** To register the CMC on the DNS server, type:

```
racadm config -g cfgLanNetworking -o  
cfgDNSRegisterRac 1
```



**NOTE:** Some DNS servers will only register names of 31 characters or fewer. Make sure the designated name is within the DNS required limit.



**NOTE:** The following settings are valid only if you have registered the CMC on the DNS server by setting `cfgDNSRegisterRac` to 1.

- **CMC Name.** By default, the CMC name on the DNS server is `cmc-<service tag>`. To change the CMC name on the DNS server, type:

```
racadm config -g cfgLanNetworking -o cfgDNSRacName  
<name>
```

where `<name>` is a string of up to 63 alphanumeric characters and hyphens; the name must begin with a letter. For example, `cmc-1, d-345`.

- **DNS Domain Name.** The default DNS domain name is a single blank character. To set a DNS domain name, type:

```
racadm config -g cfgLanNetworking -o  
cfgDNSDomainName <name>
```

where `<name>` is a string of up to 254 alphanumeric characters and hyphens; the DNS domain name must begin with a letter. For example: `p45, a-tz-1, r-id-001`.

## Configuring Auto Negotiation, Duplex Mode, and Network Speed

When enabled, the auto negotiation feature determines whether the CMC automatically sets the duplex mode and network speed by communicating with the nearest router or switch. Auto negotiation is enabled by default.

You can disable auto negotiation and specify the duplex mode and network speed by typing:

```
racadm config -g cfgNetTuning -o cfgNetTuningNicEnable 0
```

```
racadm config -g cfgNetTuning -o cfgNetTuningNicFullDuplex <duplex mode>
```

```
racadm config -g cfgNetTuning -o cfgNetTuningNicSpeed <speed>
```

where:

- *<duplex mode>* is 0 (half duplex) or 1 (full duplex, default)
- *<speed>* is 10, 100 or 1000 (default).

## Setting the Maximum Transmission Unit (MTU)

The MTU property allows you to set a limit for the largest packet that can be passed through the interface. To set the MTU, type:

```
racadm config -g cfgNetTuning -o cfgNetTuningMtu <mtu>
```

where *<mtu>* is a value between 576–1500 (inclusive; default is 1500).

## Setting the SMTP Server IP Address

You can enable the CMC to send e-mail alerts using Simple Mail Transfer Protocol (SMTP) to a specified IP address. To enable this feature, type:

```
racadm config -g cfgRemoteHosts -o  
cfgRhostsFwUpdateIpAddr <SMTP IP address>
```

where *<SMTP IP address>* is the IP address of the network SMTP server.



**NOTE:** If your network has an SMTP server that releases and renews IP address leases periodically, and the addresses are different, then there will be a duration when this property setting will not work due to change in the specified SMTP server IP address. In such cases, use the DNS name.

## Configuring the Network Security Settings



**NOTE:** To perform the following steps, you must have **Chassis Configuration Administrator** privilege.

### Enabling IP Range Checking

IP filtering compares the IP address of an incoming login to the IP address range that is specified in the following **cfgRacTuning** properties:

- **cfgRacTuneIpRangeAddr**
- **cfgRacTuneIpRangeMask**

The **cfgRacTuneIpRangeMask** property is applied to both the incoming IP address and to the **cfgRacTuneIpRangeAddr** properties. If the results are identical, the incoming login request is allowed to access the iDRAC. Logins from IP addresses outside this range receive an error.

The login proceeds if the following expression equals zero:

```
cfgRacTuneIpRangeMask & (<incoming-IP-address> ^  
cfgRacTuneIpRangeAddr)
```

where **&** is the bitwise AND of the quantities and **^** is the bitwise exclusive-OR.

## Using RACADM to Configure Users

### Before You Begin

You can configure up to 16 users in the CMC property database. Before you manually enable a CMC user, verify if any current users exist. If you are configuring a new CMC or you ran the RACADM **racresetcfg** command, the only current user is **root** with the password **calvin**. The **racresetcfg** subcommand resets the CMC back to the original defaults.



**NOTE:** Use caution when using the **racresetcfg** command, because it will reset *all* configuration parameters to the original defaults. Any previous changes are lost.



**NOTE:** Users can be enabled and disabled over time, and disabling a user does not delete the user from the database. If a user is disabled and then added again, the user may have a different index number on each chassis.

To verify if a user exists, open a Telnet/SSH text console to the CMC, log in, and type:

```
racadm getconfig -u <username>
```

or

type the following command once for each index of 1–16:

```
racadm getconfig -g cfgUserAdmin -i <index>
```

 **NOTE:** You can also type `racadm getconfig -f <myfile.cfg>` to view or edit the `myfile.cfg` file, which includes all CMC configuration parameters.

Several parameters and object IDs are displayed with their current values. Two objects of interest are:

```
# cfgUserAdminIndex=XX
```

```
cfgUserAdminUserName=
```

If the `cfgUserAdminUserName` object has no value, that index number, which is indicated by the `cfgUserAdminIndex` object, is available for use. If a name appears after the "=", that index is taken by that user name.

 **NOTE:** When you manually enable or disable a user with the `RACADM config` subcommand, you *must* specify the index with the `-i` option. Observe that the `cfgUserAdminIndex` object displayed in the previous example contains a # character. Also, if you use the `racadm config -f racadm.cfg` command to specify any number of groups/objects to write, the index cannot be specified. A new user is added to the first available index. This behavior allows more flexibility in configuring a second CMC with the same settings as the main CMC.

## Adding a CMC User

To add a new user to the CMC configuration, you can use a few basic commands. Perform the following procedures:

- 1 Set the user name.
- 2 Set the password.
- 3 Set the user privileges. For information about user privileges, see Table 5-9 and Table 5-10.
- 4 Enable the user.

## Example

The following example describes how to add a new user named "John" with a "123456" password and LOGIN privilege to the CMC.



**NOTE:** See Table B-1 for a list of valid bit mask values for specific user privileges. The default privilege value is 0, which indicates the user has no privileges enabled.

```
racadm config -g cfgUserAdmin -o cfgUserAdminUserName  
-i 2 john
```

```
racadm config -g cfgUserAdmin -o cfgUserAdminPassword  
-i 2 123456
```

```
racadm config -g cfgUserAdmin -i 2 -o cfgUserPrivilege  
0x00000001
```

```
racadm config -g cfgUserAdmin -i 2 -o  
cfgUserAdminEnable 1
```

To verify that the user was added successfully with the correct privileges, use one of the following commands:

```
racadm getconfig -u john
```

or

```
racadm getconfig -g cfgUserAdmin -i 2
```

## Enabling a CMC User With Permissions

To enable a user with specific administrative permissions (role-based authority), first locate an available user index by performing the steps in "Before You Begin" on page 77. Next, type the following command lines with the new user name and password.



**NOTE:** See Table B-1 for a list of valid bit mask values for specific user privileges. The default privilege value is 0, which indicates the user has no privileges enabled.

```
racadm config -g cfgUserAdmin -o  
cfgUserAdminPrivilege -i <index> <user privilege bitmask value>
```

## Disabling a CMC User

Using RACADM, you can only disable CMC users manually and on an individual basis. You cannot delete users by using a configuration file.

The following example illustrates the command syntax that can be used to delete a CMC user:

```
racadm config -g cfgUserAdmin -o cfgUserAdminUserName  
-i <index> ""
```

A null string of double quote characters ("" ) instructs the CMC to remove the user configuration at the specified index and reset the user configuration to the original factory defaults.

## Configuring SNMP and E-mail Alerting

You can configure the CMC to send SNMP event traps and/or e-mail alerts when certain events occur on the chassis. For more information and instructions, see "Configuring SNMP Alerts" on page 260 and "Configuring E-mail Alerts" on page 265.

## Configuring Multiple CMCs in Multiple Chassis

Using RACADM, you can configure one or more CMCs with identical properties.

When you query a specific CMC card using its group ID and object ID, RACADM creates the `racadm.cfg` configuration file from the retrieved information. By exporting the file to one or more CMCs, you can configure your controllers with identical properties in a minimal amount of time.

 **NOTE:** Some configuration files contain unique CMC information (such as the static IP address) that must be modified before you export the file to other CMCs.

- 1 Use RACADM to query the target CMC that contains the desired configuration.

 **NOTE:** The generated configuration file is `myfile.cfg`. You can rename the file.

 **NOTE:** The `.cfg` file does not contain user passwords. When the `.cfg` file is uploaded to the new CMC, you must re-add all passwords.

Open a Telnet/SSH text console to the CMC, log in, and type:

```
racadm getconfig -f myfile.cfg
```

 **NOTE:** Redirecting the CMC configuration to a file using `getconfig -f` is only supported with the remote RACADM interface.



2 Modify the configuration file using a plain-text editor (optional). Any formatting in the configuration file may corrupt the RACADM database.

3 Use the newly created configuration file to modify a target CMC.

At the command prompt, type:

```
racadm config -f myfile.cfg
```

4 Reset the target CMC that was configured. At the command prompt, type:

```
racadm reset
```

The `getconfig -f myfile.cfg` subcommand (step 1) requests the CMC configuration for the primary CMC and generates the `myfile.cfg` file. If required, you can rename the file or save it to a different location.

You can use the `getconfig` command to perform the following actions:

- Display all configuration properties in a group (specified by group name and index)
- Display all configuration properties for a user by user name

The `config` subcommand loads the information into other CMCs. The Server Administrator uses the `config` command to synchronize the user and password database.

## Creating a CMC Configuration File

The CMC configuration file, `<filename>.cfg`, is used with the `racadm config -f <filename>.cfg` command to create a simple text file. The command allows you to build a configuration file (similar to an `.ini` file) and configure the CMC from this file.

You may use any file name, and the file does not require a `.cfg` extension (although it is referred to by that designation in this subsection).



**NOTE:** For more information about the `getconfig` subcommand, see "getconfig" on page 299.

RACADM parses the `.cfg` when it is first loaded onto the CMC to verify that valid group and object names are present and that some simple syntax rules are being followed. Errors are flagged with the line number that detected the error, and a message explains the problem. The entire file is parsed for

correctness, and all errors display. Write commands are not transmitted to the CMC if an error is found in the `.cfg` file. You must correct *all* errors before any configuration can take place.

To check for errors before you create the configuration file, use the `-c` option with the `config` subcommand. With the `-c` option, config only verifies syntax and does *not* write to the CMC.

Use the following guidelines when you create a `.cfg` file:

- If the parser encounters an indexed group, it is the value of the anchored object that differentiates the various indexes.

The parser reads in all of the indexes from the CMC for that group. Any objects within that group are modifications when the CMC is configured. If a modified object represents a new index, the index is created on the CMC during configuration.

- You cannot specify a desired index in a `.cfg` file.

Indexes may be created and deleted. Over time the group may become fragmented with used and unused indexes. If an index is present, it is modified. If an index is not present, the first available index is used. This method allows flexibility when adding indexed entries where you do not need to make exact index matches between all the CMCs being managed. New users are added to the first available index. A `.cfg` file that parses and runs correctly on one CMC may not run correctly on another if all indexes are full and you must add a new user.

- Use the `racresetcfg` subcommand to configure both CMCs with identical properties.

Use the `racresetcfg` subcommand to reset the CMC to original defaults, and then run the `racadm config -f <filename>.cfg` command. Ensure that the `.cfg` file includes all desired objects, users, indexes, and other parameters. See "CMC Property Database Group and Object Definitions" on page 347 for a complete list of objects and groups.



**NOTICE:** Use the `racresetcfg` subcommand to reset the database and the CMC NIC settings to the original default settings and remove all users and user configurations. While the root user is available, other users' settings are also reset to the default settings.

## Parsing Rules

- Lines that start with a hash character (#) are treated as comments. A comment line *must* start in column one. A "#" character in any other column is treated as a # character.

Some modem parameters may include # characters in their strings. An escape character is not required. You may want to generate a .cfg from a `racadm getconfig -f <filename>.cfg` command, and then perform a `racadm config -f <filename>.cfg` command to a different CMC, without adding escape characters.

Example:

```
#
# This is a comment
[cfgUserAdmin]
cfgUserAdminPageModemInitString=<Modem init # not
a comment>
```

- All group entries must be surrounded by open- and close-brackets ([ and ]).

The starting [ character that denotes a group name *must* be in column one. This group name *must* be specified before any of the objects in that group. Objects that do not include an associated group name generate an error. The configuration data is organized into groups as defined in "CMC Property Database Group and Object Definitions" on page 347.

The following example displays a group name, object, and the object's property value:

```
[cfgLanNetworking] -{group name}
cfgNicIpAddress=143.154.133.121 {object name}
{object value}
```

- All parameters are specified as "object=value" pairs with no white space between the object, =, or value.

White spaces that are included after the value are ignored. A white space inside a value string remains unmodified. Any character to the right of the = (for example, a second =, a #, [, ], and so on) is taken as-is. These characters are valid modem chat script characters.

```
[cfgLanNetworking] -{group name}
cfgNicIpAddress=143.154.133.121 {object value}
```

- The `.cfg` parser ignores an index object entry. You *cannot* specify which index is used. If the index already exists, it is either used or the new entry is created in the first available index for that group.

The `racadm getconfig -f <filename>.cfg` command places a comment in front of index objects, allowing you to see the included comments.

 **NOTE:** You may create an indexed group manually using the following command:

```
racadm config -g <groupName> -o <anchored
object> -i <index 1-16> <unique anchor name>
```

- The line for an indexed group *cannot* be deleted from a `.cfg` file. If you do delete the line with a text editor, RACADM will stop when it parses the configuration file and alert you of the error.

You must remove an indexed object manually using the following command:

```
racadm config -g <groupName> -o <objectName> -i
<index 1-16> " "
```

 **NOTE:** A NULL string (identified by two " characters) directs the CMC to delete the index for the specified group.

To view the contents of an indexed group, use the following command:

```
racadm getconfig -g <groupName> -i <index 1-16>
```

- For indexed groups the object anchor *must* be the first object after the [ ] pair. The following are examples of the current indexed groups:

```
[cfgUserAdmin]
```

```
cfgUserAdminUserName=<USER_NAME>
```

If you type `racadm getconfig -f <myexample>.cfg`, the command builds a `.cfg` file for the current CMC configuration. This configuration file can be used as an example and as a starting point for your unique `.cfg` file.

## Modifying the CMC IP Address

When you modify the CMC IP address in the configuration file, remove all unnecessary `<variable>=<value>` entries. Only the actual variable group's label with `[ and ]` remains, including the two `<variable>=<value>` entries pertaining to the IP address change.

Example:

```
#  
#   Object Group "cfgLanNetworking"  
#  
[cfgLanNetworking]  
cfgNicIpAddress=10.35.10.110  
cfgNicGateway=10.35.10.1
```

This file will be updated as follows:

```
#  
#   Object Group "cfgLanNetworking"  
#  
[cfgLanNetworking]  
cfgNicIpAddress=10.35.9.143  
# comment, the rest of this line is ignored  
cfgNicGateway=10.35.9.1
```

The command `racadm config -f <myfile>.cfg` parses the file and identifies any errors by line number. A correct file will update the proper entries. Additionally, you can use the same `getconfig` command from the previous example to confirm the update.

Use this file to download company-wide changes or to configure new systems over the network with the command, `racadm getconfig -f <myfile>.cfg`.



**NOTE:** "Anchor" is a reserved word and should not be used in the `.cfg` file.

# Troubleshooting

Table 4-3 lists common problems related to remote RACADM.

**Table 4-3. Using the Serial and RACADM Commands: Frequently Asked Questions**

Question	Answer
After performing a CMC reset (using the RACADM <code>racreset</code> subcommand), I issue a command and the following message is displayed:	You must wait until the CMC completes the reset before issuing another command.
<pre>racadm &lt;subcommand&gt; Transport: ERROR: (RC=-1)</pre>	
What does this message mean?	
When I use the RACADM subcommands, I get errors that I do not understand.	You may encounter one or more of the following errors when using RACADM: <ul style="list-style-type: none"><li>• Local error messages — Problems such as syntax, typographical errors, and incorrect names. Example: <pre>ERROR: &lt;message&gt;</pre>Use the RACADM <code>help</code> subcommand to display correct syntax and usage information.</li><li>• CMC-related error messages — Problems where the CMC is unable to perform an action. Also might say "racadm command failed." Type <code>racadm gettracelog</code> for debugging information.</li></ul>
While I was using remote RACADM, the prompt changed to a ">" and I cannot get the "\$" prompt to return.	If you type a double quotation mark (") in the command, the CLI will change to ">" prompt and queue all commands. To return to the "\$" prompt, type <code>&lt;Ctrl&gt;-d</code> .

# Using the CMC Web Interface

The CMC provides a Web interface that enables you to configure the CMC properties and users, perform remote management tasks, and troubleshoot a remote (managed) system for problems. For everyday chassis management, use the CMC Web interface. This chapter provides information about how to perform common chassis management tasks using the CMC Web interface.

You can also perform all of the Web interface configuration tasks using local RACADM commands or command line consoles (serial console, Telnet, or SSH). For more information about using local RACADM, see "Using the RACADM Command Line Interface" on page 65. For information on using command line consoles, see "Configuring CMC to Use Command Line Consoles" on page 53.



**NOTE:** If you are using Microsoft® Internet Explorer®, connecting through a proxy, and see the error "The XML page cannot be displayed," you will need to disable the proxy to continue.

## Accessing the CMC Web Interface

To access the CMC Web interface:

- 1 Open a supported Web browser window.  
For more information, see "Supported Web Browsers" on page 27.
- 2 Type the following URL in the **Address** field, and then press <Enter>:

```
https://<CMC IP address>
```





If the default HTTPS port number (port 443) has been changed, type:

```
https://<CMC IP address>:<port number>
```

where <IP address> is the IP address for the CMC and *port number* is the HTTPS port number.



The CMC **Login** page appears.

## Logging In

-  **NOTE:** To log in to the CMC, you must have a CMC account with **Log In to CMC** privilege.
-  **NOTE:** The default CMC user name is **root**, and the password is **calvin**. The root account is the default administrative account that ships with the CMC. For added security, Dell strongly recommends that you change the default password of the root account during initial setup.
-  **NOTE:** The CMC does not support extended ASCII characters, such as ß, å, é, ü, or other characters used primarily in non-English languages.
-  **NOTE:** You cannot log in to the Web interface with different user names in multiple browser windows on a single workstation.



You can log in as either a CMC user or as a Microsoft® Active Directory® user.

To log in:

- 1 In the **Username** field, type your user name:
  - CMC user name: *<user name>*
  - Active Directory user name: *<domain>\<user name>*,  
*<domain>/<user name>* or *<user>@<domain>*. **NOTE:** This field is case sensitive.
- 2 In the **Password** field, type your CMC user password or Active Directory user password. **NOTE:** This field is case sensitive.
- 3 Click **OK** or press **<Enter>**.

## Logging Out

When you are logged in to the Web interface, you can log out at any time by clicking **Logout** in the upper right corner of any page.

-  **NOTE:** Be careful to apply (save) any settings or information you enter on a page. If you log out or navigate away from that page without applying your changes, the changes will be lost.
-  **NOTE:** Closing the browser without logging out first causes your session to remain open until it times out. Dell strongly recommends that you log out properly, by clicking the **Logout** button, before you close the browser.



# Configuring Basic CMC Settings

## Setting the Chassis Name

You can set the name used to identify the chassis on the network. (The default name is "Dell Rack System.") For example, an SNMP query on the chassis name will return the name you configure.

To set the chassis name:

- 1 Log in to the CMC Web interface. The **Component Health** page displays.
- 2 Click the **Setup** tab. The **General Chassis Settings** page displays.
- 3 Type the new name in the **Chassis Name** field, and then click **Apply**.

## Setting the Date and Time on the CMC

- 1 Log in to the CMC Web interface. The **Component Health** page displays.
- 2 Click the **Setup** tab. The **General Chassis Settings** page displays.
- 3 Click the **Date/Time** sub-tab. The **Date/Time** page displays.
- 4 Set date, time, and time zone settings, and then click **Apply**.

# Monitoring System Health Status

## Viewing Chassis and Component Summaries

The CMC provides rollup overviews of the chassis, primary and stand by CMCs, iKVM, and I/O modules (IOMs). For instructions on viewing chassis and components summaries, see "Viewing Chassis Summaries" on page 268.

## Viewing Chassis and Component Health Status

The **Component Health** page provides rollup overviews of the chassis, primary and standby CMCs, iKVM, fans, temperature sensors, and I/O modules (IOMs).

For instructions on viewing chassis and component health status, see "Viewing Chassis and Component Health Status" on page 272.

## Viewing Power Budget Status

The **Power Budget Status** page displays the power budget status for the chassis, servers, and chassis power supply units (PSUs).

For instructions on viewing power budget status, see "Viewing Power Budget Status" on page 207. For more information about CMC power management, see "Power Management" on page 197.

## Viewing the Health Status of All Servers



The **Servers Status** page provides overviews of the servers in the chassis.

To view health status for all servers:

- 1 Log in to the CMC Web interface.
- 2 Select **Servers** in the system tree. The **Servers Status** page appears.

Table 5-1 provides descriptions of the information provided on the **Servers Status** page.

**Table 5-1. All Servers Status Information**

Item	Description
Slot #	Displays the location of the server. The slot number is a sequential number that identifies the server by its location within the chassis.
Present	Indicates whether the server is present in the slot ( <b>Present</b> or <b>Absent</b> ). When the server is absent, the health, power state, and service tag information of the server is unknown (not displayed).
Health	 OK Indicates that the server is present and communicating with the CMC.
	 Informational Displays information about the server when no change in health status has occurred.
	 Warning Indicates that only warning alerts have been issued, and <b>corrective action must be taken within the time frame set by the administrator</b> . If corrective actions are not taken within the administrator-specified time, critical or severe failures that can affect the integrity of the device could occur.

**Table 5-1. All Servers Status Information (continued)**

Item	Description
Health (continued)	 Severe Indicates at least one Failure alert has been issued. Severe status represents a system failure on the server, and <b>corrective action must be taken immediately</b> .  No Value When the server is absent from the slot, health information is not provided.
Name	Indicates the name of the server, which by default is identified by its <b>slot name</b> (SLOT-01 to SLOT-16). <b>NOTE:</b> You can change the server name from the default. For instructions, see "Editing Slot Names".
Power State	Indicates the power status of the system: <b>On</b> , <b>Off</b> , or <b>N/A</b> (Absent).
Service Tag	Displays the service tag for the server. The service tag a unique identifier provided by the manufacturer for support and maintenance. If the server is absent, this field is empty.

## Editing Slot Names

The **Slot Names** page allows you to update slot names in the chassis. Slot names are used to identify individual servers. When choosing slot names, the following rules apply:

- Names may contain only printable ASCII characters (ASCII codes 32 through 126), excluding the double quote (", ASCII 34).
- Slot names must be unique within the chassis. No two slots may have the same name.
- Strings are not case-sensitive. **Server-1**, **server-1**, and **SERVER-1** are equivalent names.
- Slot names must not begin with the following strings:
  - Switch-
  - Fan-
  - PS-
  - KVM
  - DRAC-

- MC-
- Chassis
- Housing-Left
- Housing-Right
- Housing-Center
- The strings `Server-1` through `Server-16` may be used, but only for the corresponding slot. For example, `Server-3` is a valid name for slot 3, but not for slot 4. Note that `Server-03` is a valid name for *any* slot.



**NOTE:** To change a slot name in the Web interface, you must have **Chassis Configuration Administrator** privilege.



**NOTE:** The slot name setting in the Web interface resides on the CMC only. If a server is removed from the chassis, the slot name setting does not remain with the server.



**NOTE:** The slot name setting in the CMC Web interface always overrides any change you make to the display name in the iDRAC interface.

To edit a slot name:

- 1 Log in to the CMC Web interface.
- 2 Select **Servers** in the **Chassis** menu in the system tree.
- 3 Click the **Setup** tab. The **Slot Names** page displays.
- 4 Type the updated or new name for a slot in the **Slot Name** field. Repeat this action for each slot you want to rename.
- 5 Click **Apply**.

## Setting the First Boot Device for Servers

The **First Boot Device** page allows you to specify the boot device for each server. You can set the default boot device and you can also set a one-time boot device so that you can boot a special image to perform tasks such as running diagnostics or reinstalling an operating system.

The boot device that you specify must exist and contain bootable media. Table 5-2 lists the boot devices that you can specify.

**Table 5-2. Boot Devices**

<b>Boot Device</b>	<b>Description</b>
PXE	Boot from a Preboot Execution Environment (PXE) protocol on the network interface card.
Hard Drive	Boot from the hard drive on the server.
Local CD/DVD	Boot from a CD/DVD drive on the server.
Virtual Floppy	Boot from the virtual floppy drive. The floppy drive (or a floppy disk image) is on another computer on the management network, and is attached using the iDRAC GUI console viewer.
Virtual CD/DVD	Boot from a virtual CD/DVD drive or CD/DVD ISO image. The optical drive or ISO image file is located on another computer or disk available on the management network and is attached using the iDRAC GUI console viewer.
iSCSI	Boot from an Internet Small Computer System Interface (iSCSI) device.
Floppy	Boot from a floppy disc in the local Floppy disc drive.



**NOTE:** To set the first boot device for servers you must have **Server Administrator** privilege or **Chassis Configuration Administrator** privilege and a login on the iDRAC.

To set the first boot device for some or all servers in the chassis:

- 1 Log in to the CMC Web interface.
- 2 Click **Servers** in the system tree and then click **Setup**→**Deploy First Boot Device**. A list of servers is displayed, one per row.
- 3 Select the boot device you want to use for each server. from the list box.

- 4 If you want the server to boot from the selected device every time it boots, uncheck the **Boot Once** checkbox for the server.  
If you want the server to boot from the selected device only on the next boot cycle, select the **Boot Once** checkbox for the server.
- 5 Click **Apply**.

## Viewing the Health Status of an Individual Server

The **Server Status** page (separate from the *Servers Status* page) provides an overview of the server and a launch point to the Web interface for the Integrated Dell Remote Access Controller (iDRAC), which is the firmware used to manage the server.



**NOTE:** To use the iDRAC user interface, you must have an iDRAC user name and password. For more information about iDRAC and the using the iDRAC Web interface, see the *Integrated Dell Remote Access Controller Firmware Version 1.00 User's Guide*.

To view the health status of an individual server:





- 1 Log in to the CMC Web interface.
- 2 Expand **Servers** in the system tree. All of the servers (1–16) appear in the expanded **Servers** list.
- 3 Click the server you want to view. The **Server Status** page displays.

Table 5-3 provides descriptions of the information provided on the **Server Status** page.

**Table 5-3. Individual Server Status Information**

Item	Description
Slot	Indicates the slot occupied by the server on the chassis. Slot numbers are sequential IDs, from 1 through 16 (there are 16 slots available on the chassis), that help identify the location of the server in the chassis.
Slot Name	Indicates the name of the slot where the server resides.
Present	Indicates whether the server is present in the slot (Present or Absent). When the server is absent, the health, power state, and service tag information of the server is unknown (not displayed).

**Table 5-3. Individual Server Status Information (continued)**

Item	Description
Health	 OK Indicates that the server is present and communicating with the CMC. In the event of a communication failure between the CMC and the server, the CMC cannot obtain or display health status for the server.
	 Informational Displays information about the server when no change in health status (OK, Warning, Severe) has occurred.
	 Warning Indicates that only warning alerts have been issued, and <b>corrective action must be taken within the time frame set by the administrator</b> . If corrective actions are not taken within the administrator-specified time, critical or severe failures that can affect the integrity of the server could occur.
	 Severe Indicates at least one Failure alert has been issued. Severe status represents a system failure on the server, and <b>corrective action must be taken immediately</b> .
	No Value When the server is absent from the slot, health information is not provided.
Server Model	Indicates the model of the server in the chassis. Examples: <b>PowerEdge M600</b> or <b>PowerEdge M605</b> .
Service Tag	Displays the service tag for the server. The service tag a unique identifier provided by the manufacturer for support and maintenance. If the server is absent, this field is empty.
Server Firmware	Indicates the iDRAC version currently installed on the server.
BIOS version	Indicates the BIOS version on the server.
Operating System	Indicates the operating system on the server.

## Viewing the Health Status of IOMs

The **I/O Modules Status** page provides overviews of all IOMs associated with the chassis. For instructions on viewing IOM health through the Web interface or RACADM, see "Monitoring IOM Health" on page 254.

## Viewing the Health Status of the Fans



**NOTE:** During updates of CMC or iDRAC firmware on a server, some or all of the fan units in the chassis will spin at 100%. This is normal.

The **Fans Status** page provides the status and speed measurements (in revolutions per minute, or RPM) of the fans in the chassis. There can be one or more fans.

The CMC, which controls fan speeds, automatically increases or decreases fan speeds based on system wide events. The CMC generates an alert and increases the fan speeds when the following events occur:

- The CMC ambient temperature threshold is exceeded.
- A fan fails.
- A fan is removed from the chassis.

To view the health status of the fan units:

- 1 Log in to the CMC Web interface.
- 2 Select **Fans** in the system tree. The **Fans Status** page displays.



Table 5-4 provides descriptions of the information provided on the **Fans Status** page.

**Table 5-4. Fans Health Status Information**

Item	Description
Present	Indicates whether the temperature probe is present ( <b>Yes</b> or <b>No</b> ).
Health	 OK Indicates that the fan unit is present and communicating with the CMC. In the event of a communication failure between the CMC and the fan unit, the CMC cannot obtain or display health status for the IOM.



**Table 5-4. Fans Health Status Information (continued)**

Item	Description
 Severe	Indicates at least one Failure alert has been issued. Severe status represents a system failure on the IOM, and <b>corrective action must be taken immediately</b> to prevent overheating and system shutdown.
 Unknown	Displayed when the chassis is first powered on. In the event of a communication failure between the CMC and the fan unit, the CMC cannot obtain or display health status for the fan unit.
Name	Displays the fan name in the format <b>FAN-<i>n</i></b> , where <i>n</i> is the fan number.
Speed	Indicates the speed of the fan in revolutions per minute (RPM).

## Viewing the iKVM Status

The local access KVM module for your Dell M1000e server chassis is called the Avocent<sup>®</sup> Integrated KVM Switch Module, or iKVM.

For instructions on viewing iKVM status and setting properties for the iKVM, see:

- "Viewing the iKVM Status and Properties" on page 244
- "Enabling or Disabling the Front Panel" on page 243
- "Enabling the Dell CMC Console via iKVM" on page 243
- "Updating the iKVM Firmware" on page 245

For more information about iKVM, see "Using the iKVM Module" on page 225.

## Viewing the Health Status of the PSUs



The **Power Supply Status** page displays the status and readings of the PSUs associated with the chassis. For more information about CMC power management, see "Power Management" on page 197.

To view the health status of the PSUs:

- 1 Log in to the CMC Web interface.
- 2 Select **Power Supplies** in the system tree. The **Power Supply Status** page displays.

Table 5-5 provides descriptions of the information provided on the **Power Supply Status** page.

**Table 5-5. Power Supply Health Status Information**

Item	Description	
Present	Indicates whether the power supply is present (Yes or No).	
Health	 OK	Indicates that the PSU is present and communicating with the CMC. Indicates that the health of the PSU is OK. In the event of a communication failure between the CMC and the fan unit, the CMC cannot obtain or display health status for the PSU.
	 Severe	Indicates that the PSU has a failure and the health is critical. <b>Corrective action must be taken immediately.</b> Failure to do so may cause the component to shutdown due to power loss.
	 Unknown	Displayed with the chassis is first powered on. In the event of a communication failure between the CMC and the PSU, the CMC cannot obtain or display health status for the PSU.
Name	Displays the name of the PSU: PS- <b>■</b> , where <b>■</b> is the power supply number.	
Power Status	Indicates the power state of the PSU: <b>Online</b> , <b>Off</b> , or <b>Slot Empty</b> .	
Capacity	Displays the power capacity in watts.	

## Viewing Status of the Temperature Sensors

The **Temperature Sensors Information** page displays the status and readings of the temperature probes on the entire chassis (chassis, servers, IOMs, and iKVM).



**NOTE:** The temperature probes value cannot be edited. Any change beyond the threshold will generate an alert that will cause the fan speed to vary. For example, if the CMC ambient temperature probe exceeds threshold, the speed of the fans on the chassis will increase.

To view the health status of the temperature probes:

- 1 Log in to the CMC Web interface.
- 2 Select **Temperature Sensors** in the system tree. The **Temperature Sensors Information** page displays.

Table 5-6 provides descriptions of the information provided on the **Temperature Sensors Information** page.

**Table 5-6. Temperature Sensors Health Status Information**

Item	Description
Present	Indicates whether the sensor is present (Yes) or absent (No) in the chassis.
Temperature ID	Displays the numeric ID of the temperature probe.
Name	Displays the name of each temperature probe on the chassis, servers, IOMs, and iKVM. Examples: Ambient Temp, Server 1 Temp, I/O Module 1, iKVM Temp.
Reading	Indicates the current temperature in degrees Centigrade.
Threshold Maximum	Indicates the highest temperature, in degrees Centigrade, at which a Failure alert is issued.
Threshold Minimum	Indicates the lowest temperature, in degrees Centigrade, at which a Failure alert is issued.

# Configuring CMC Network Properties

## Setting Up Initial Access to the CMC

 **NOTE:** You must have **Chassis Configuration Administrator** privilege to set up CMC network settings.

- 1 Log in to the Web interface.
- 2 Select **Chassis** in the system tree. The **Component Health** page appears.
- 3 Click the **Network/Security** tab. The **Network Configuration** page appears.
- 4 Enable or disable DHCP for the CMC by selecting or clearing the **Use DHCP (For CMC NIC IP Address)** check box.
- 5 If you disabled DHCP, type the IP address, gateway, and subnet mask.
- 6 Click **Apply Changes** at the bottom of the page.

## Configuring the Network LAN Settings

 **NOTE:** To perform the following steps, you must have **Chassis Configuration Administrator** privilege.

 **NOTE:** The settings on the **Network Configuration** page, such as community string and SMTP server IP address, affect both the CMC and the external settings of the chassis.

 **NOTE:** If you have two CMCs (primary and standby) on the chassis, and they are both connected to the network, the standby CMC automatically assumes the network settings in the event of failover of the primary CMC.

- 1 Log in to the Web interface.
- 2 Click the **Network/Security** tab.
- 3 Configure the CMC network settings described in Table 5-7.
- 4 Click **Apply Changes**.

To configure IP range and IP blocking settings, click the **Advanced Settings** button (see "Configuring CMC Network Security Settings" on page 105).

To refresh the contents of the **Network Configuration** page, click **Refresh**.

To print the contents of the **Network Configuration** page, click **Print**.

**Table 5-7. Network Settings**

<b>Setting</b>	<b>Description</b>
MAC Address	Displays the chassis' MAC address, which is a unique identifier for the chassis over the network.
Enable NIC	<p>Enables the NIC of the CMC.</p> <p><b>Default:</b> Enabled. If this option is checked:</p> <ul style="list-style-type: none"><li>• The CMC communicates with and is accessible over the computer network.</li><li>• The Web interface, CLI (remote RACADM), WSMAN, Telnet, and SSH associated with the CMC are available.</li></ul> <p>If this option is not checked:</p> <ul style="list-style-type: none"><li>• The CMC NIC cannot communicate over the network.</li><li>• Communication to the chassis through CMC is not available.</li><li>• The Web interface, CLI (remote RACADM), WSMAN, Telnet, and SSH associated with the CMC are not available.</li><li>• The server iDRAC Web interface, local CLI, I/O modules, and iKVM are still accessible.</li><li>• Network addresses for the iDRAC and CMC can be obtained, in this case, from the chassis' LCD.</li></ul> <p><b>NOTE:</b> Access to the other network-accessible components in the chassis is not affected when the network on the chassis is disabled (or lost).</p>

**Table 5-7. Network Settings (continued)**

<b>Setting</b>	<b>Description</b>
Use DHCP (For CMC NIC IP Address)	<p>Enables the CMC to request and obtain an IP address from the Dynamic Host Configuration Protocol (DHCP) server automatically.</p> <p><b>Default:</b> Checked (enabled)</p> <p><b>If this option is checked,</b> the CMC retrieves IP configuration (IP address, mask, and gateway) automatically from a DHCP server on your network. The CMC will always have a unique IP address allotted over your network.</p> <p><b>NOTE:</b> When this feature is enabled, the <b>IP address, Gateway, and Mask</b> property fields (located immediately following this option on the Network Configuration page) are disabled, and any previously entered values for these properties are ignored.</p> <p>If this option is <i>not</i> checked, you must manually type the IP address, gateway, and mask in the text fields immediately following this option on the <b>Network Configuration</b> page.</p>
• Static CMC IP Address	Specifies or edits the static IP address for the CMC NIC. To change this setting, deselect the <b>Use DHCP (For NIC IP Address)</b> check box.
• Static Gateway	Specifies or edits the static gateway for the CMC NIC. To change this setting, deselect the <b>Use DHCP (For NIC IP Address)</b> check box.
• Static Subnet Mask	Specifies or edits the static mask for the CMC NIC. To change this setting, deselect the <b>Use DHCP (For NIC IP Address)</b> check box.

**Table 5-7. Network Settings (continued)**

Setting	Description
Use DHCP to Obtain DNS Server Addresses	<p>Obtains the primary and secondary DNS server addresses from the DHCP server instead of the static settings.</p> <p><b>Default:</b> Unchecked (disabled) by default</p> <p><b>NOTE:</b> If <b>Use DHCP (For NIC IP Address)</b> is enabled, then enable the <b>Use DHCP to Obtain DNS Server Addresses</b> property.</p> <p>If this option is checked, the CMC retrieves its DNS IP address automatically from a DHCP server on your network.</p> <p><b>NOTE:</b> When this property is enabled, the <b>Static Preferred DNS Server</b> and <b>Static Alternate DNS Server</b> property fields (located immediately following this option on the <b>Network Configuration</b> page) are inactivated, and any previously entered values for these properties are ignored.</p> <p>If this option is <b>not</b> checked, the CMC retrieves the DNS IP address from the <b>Static Preferred DNS Server</b> and <b>Static Alternate DNS Server</b>. The addresses of these servers are specified in the text fields immediately following this option on the <b>Network Configuration</b> page.</p>
• <b>Static Preferred DNS Server</b>	<p>Specifies the static IP address for the preferred DNS Server. The <b>Static Preferred DNS Server</b> is implemented only when <b>Use DHCP to Obtain DNS Server Addresses</b> is disabled.</p>
• <b>Static Alternate DNS Server</b>	<p>Specifies the static IP address for the alternate DNS Server. The <b>Static Alternate DNS Server</b> is implemented only when <b>Use DHCP to obtain DNS Server addresses</b> is disabled. If you do not have an alternate DNS Server, type an IP address of 0.0.0.0.</p>
Register CMC on DNS	<p>This property registers the CMC name on the DNS Server.</p> <p><b>Default:</b> Unchecked (disabled) by default</p> <p><b>NOTE:</b> Some DNS Servers will only register names of 31 characters or fewer. Make sure the designated name is within the DNS required limit.</p>

**Table 5-7. Network Settings (continued)**

<b>Setting</b>	<b>Description</b>
DNS CMC Name	Displays the CMC name only when <b>Register CMC on DNS</b> is selected. The default CMC name is <i>CMC_service_tag</i> , where <i>service tag</i> is the service tag number of the chassis. Example: CMC-00002
Use DHCP for DNS Domain Name	Uses the default DNS domain name. This check box is active only when <b>Use DHCP (For NIC IP Address)</b> is selected. <b>Default:</b> Disabled
DNS Domain Name	The default DNS Domain Name is a blank character. This field is only editable when the <b>Use DHCP for DNS Domain Name</b> check box is selected.
Auto Negotiation	Determines whether the CMC automatically sets the duplex mode and network speed by communicating with the nearest router or switch ( <b>On</b> ) or allows you to set the duplex mode and network speed manually ( <b>Off</b> ). <b>Default:</b> On <b>If Auto Negotiation is On</b> , CMC automatically communicates with the nearest router or switch. <b>If Auto Negotiation is Off</b> , you must set the duplex mode and network speed manually.
Network Speed	Set the network speed to 1Gbps, 100 Mbps, or 10 Mbps to match your network environment. <b>NOTE:</b> The Network Speed setting must match your network configuration for effective network throughput. Setting the Network Speed lower than the speed of your network configuration increases bandwidth consumption and slows network communication. <b>Determine whether your network supports the above network speeds and set it accordingly.</b> If your network configuration does not match any of these values, Dell recommends that you use Auto Negotiation or refer to your network equipment manufacturer.



**Table 5-7. Network Settings (continued)**

Setting	Description
Duplex Mode	<p>Set the duplex mode to full or half to match your network environment.</p> <p><b>Implications:</b> If <b>Auto Negotiation</b> is turned On for one device but not the other, then the device using auto negotiation can determine the network speed of the other device, but not the duplex mode. In this case, duplex mode defaults to the half duplex setting during auto negotiation. such a duplex mismatch will result in a slow network connection.</p> <p><b>NOTE:</b> The network speed and duplex mode settings are not available if Auto Negotiation is set to On.</p>
MTU	<p>Sets the size of the Maximum Transmission Unit (MTU), or the largest packet that can be passed through the interface.</p> <p><b>Configuration range:</b> 576–1500.</p> <p><b>Default:</b> 1500.</p>

## Configuring CMC Network Security Settings



**NOTE:** To perform the following steps, you must have **Chassis Configuration Administrator** privilege.

- 1 Log in to the Web interface.
- 2 Click the **Network/Security** tab. The **Network Configuration** page displays.
- 3 Click the **Advanced Settings** button. The **Network Security** page displays.
- 4 Configure the CMC network security settings.

Table 5-8 describes the settings on the **Network Security** page.

**Table 5-8. Network Security Page Settings**

Settings	Description
IP Range Enabled	Enables the IP Range checking feature, which defines a specific range of IP addresses that can access the CMC.
IP Range Address	Determines the base IP address for range checking.

**Table 5-8. Network Security Page Settings (continued)**

Settings	Description
IP Range Mask	<p>Defines a specific range of IP addresses that can access the CMC, a process called IP range checking.</p> <p>IP range checking allows access to the CMC only from clients or management stations whose IP addresses are within the user-specified range. All other logins are denied.</p> <p>For example:</p> <p>IP range mask: 255.255.255.0 (11111111.11111111.11111111.00000000)</p> <p>IP range address: 192.168.0.255 (11000000.10101000.00000000.11111111)</p> <p>The resulting IP address range is any address that contains 192.168.0, that is, any address from 192.168.0.0 through 192.168.0.255.</p>
IP Blocking Enabled	<p>Enables the IP address blocking feature, which limits the number of failed login attempts from a specific IP address for a pre-selected time span.</p>
• IP Blocking Fail Count	<p>Sets the number of login failures attempted from an IP address before the login attempts are rejected from that address.</p>
• IP Blocking Fail Window	<p>Determines the time span in seconds within which IP Blocking Fail Count failures must occur to trigger the IP Block Penalty Time.</p>
• IP Blocking Penalty Time	<p>The time span in seconds within which login attempts from an IP address with excessive failures are rejected.</p> <p><b>NOTE:</b> The IP Blocking Fail Count, IP Blocking Fail Window, and IP Blocking Penalty Time fields are active only if the IP Blocking Enabled check box (the property field preceding these fields) is checked (enabled). In that case, you must manually type IP Blocking Fail Count, IP Blocking Fail Window, and IP Blocking Penalty Time properties.</p>

**5** Click **Apply Changes** to save your settings.

To refresh the contents of the **Network Security** page, click **Refresh**.

To print the contents of the **Network Security** page, click **Print**.

## Adding and Configuring CMC Users

To manage your system with the CMC and maintain system security, create unique users with specific administrative permissions (*or role-based authority*). For additional security, you can also configure alerts that are e-mailed to specific users when a specific system event occurs.

### User Types

There are two types of users: CMC users and iDRAC users. CMC users are also known as "chassis users." Since iDRAC resides on the server, iDRAC users are also known as "server users."

CMC users can be local users or Active Directory users. iDRAC users can also be local users or Active Directory users.

Except where a CMC user has Server Administrator privilege, privileges granted to a CMC user are not automatically transferred to the same user on a server, because server users are created independently from CMC users. In other words, CMC Active Directory users and iDRAC Active Directory users reside on two different branches in the Active Directory tree. To create a local server user, the User Configuration Administrator must log into the server directly. The User Configuration Administrator cannot create a server user from CMC or vice versa. This rule protects the security and integrity of the servers.

Table 5-9, Table 5-10, and Table 5-11 describe CMC user privileges (local or Active Directory), and what operations a CMC user can execute on the chassis and on the servers based on the privileges he is granted. The term user or users, therefore, should be understood as CMC users. Server users will be explicitly specified.

**Table 5-9. User Types**

<b>Privilege</b>	<b>Description</b>
<b>CMC Login User</b>	<p>Users who have the <b>CMC Login User</b> privilege can log in to CMC. A user with only the login privilege can view all of the CMC data but cannot add or modify data or execute commands.</p> <p>It is possible for a user to have other privileges without the login privilege. This feature is useful when a user is temporarily disallowed to login. When that user's login privilege is restored, the user retains all the other privileges previously granted.</p>
<b>Chassis Configuration Administrator</b>	<p>Users who have the Chassis Configuration Administrator privilege can add or change data that:</p> <ul style="list-style-type: none"><li>• Identifies the chassis, such as chassis name and chassis location</li><li>• Is assigned specifically to the chassis, such as IP mode (static or DHCP), static IP address, static gateway, and static subnet mask</li><li>• Provides services to the chassis, such as date and time, firmware update, and CMC reset</li></ul>
<b>Chassis Configuration Administrator (continued)</b>	<ul style="list-style-type: none"><li>• Is associated with the chassis, such as slot name and slot priority. Although these properties apply to the servers, they are strictly chassis properties relating to the slots rather than the servers themselves. For this reason, slot names and slot priorities can be added or changed whether or not servers are present in the slots.</li></ul> <p>When a server is moved to a different chassis, it inherits the slot name and priority assigned to the slot of it occupies in the new chassis. Its previous slot name and priority remain with the previous chassis.</p>

**Table 5-9. User Types** *(continued)*

<b>Privilege</b>	<b>Description</b>
<b>User Configuration Administrator</b>	<p>Users who have the User Configuration Administrator privilege can:</p> <ul style="list-style-type: none"><li>• Add a new user</li><li>• Delete an existing user</li><li>• Change a user's password</li><li>• Change a user's privileges</li><li>• Enable or disable a user's login privilege but retain the user's name and other privileges in the database.</li></ul>
<b>Clear Logs Administrator</b>	<p>CMC users who have the Clear Administrator privilege can clear the hardware log and CMC log.</p>
<b>Chassis Power Administrator</b>	<p>CMC users with the Chassis Power Administrator privilege can perform all power-related operations:</p> <ul style="list-style-type: none"><li>• Control chassis power operations, including power on, power off, and power cycle.</li></ul>

**Table 5-9. User Types (continued)**

Privilege	Description
<b>Server Administrator</b>	<p data-bbox="378 280 958 368">The Server Administrator privilege is a blanket privilege granting a CMC user all rights to perform any operation on any servers present in the chassis.</p> <p data-bbox="378 379 958 555">When a user with CMC Server Administrator privilege issues an action to be performed on a server, the CMC firmware sends the command to the targeted server without checking the user's privileges on the server. In other words, the CMC Server Administrator privilege overrides any lack of administrator privileges on the server.</p> <p data-bbox="378 566 958 654">Without the Server Administrator privilege, a user created on the chassis can only execute a command on a server when all of the following conditions are true:</p> <ul data-bbox="385 665 964 802" style="list-style-type: none"><li data-bbox="385 665 796 689">• The same user name exists on the server</li><li data-bbox="385 707 953 762">• The same user name must have the exact same password on the server</li><li data-bbox="385 780 964 802">• The user must have the privilege to execute the command</li></ul> <p data-bbox="378 813 958 989">When a CMC user who does not have Server Administrator privilege issues an action to be performed on a server, the CMC will send a command to the targeted server with the user's login name and password. If the user does not exist on the server, or if the password does not match, the user is denied the ability to perform the action.</p> <p data-bbox="378 1000 958 1152">If the user exists on the target server and the password matches, the server responds with the privileges of which the user was granted on the server. Based on the privileges responding from the server, CMC firmware decides if the user has the right to perform the action.</p> <p data-bbox="378 1163 958 1279">Listed below are the privileges and the actions on the server to which the Server Administrator is entitled. These rights are applied only when the chassis user does not have the Server Administrative privilege on the chassis.</p>

**Table 5-9. User Types (continued)**

<b>Privilege</b>	<b>Description</b>
<b>Server Administrator (continued)</b>	Server Configuration Administrator: <ul style="list-style-type: none"><li>• Set IP address</li><li>• Set gateway</li><li>• Set subnet mask</li><li>• Set first boot device</li></ul> User Configuration Administrator: <ul style="list-style-type: none"><li>• Set iDRAC root password</li><li>• iDRAC reset</li></ul> Server Control Administrator: <ul style="list-style-type: none"><li>• Power on</li><li>• Power off</li><li>• Power cycle</li><li>• Graceful shutdown</li><li>• Server Reboot</li></ul>
<b>Test Alert User</b>	CMC users who have the Test Alert User privilege can send test alert messages.
<b>Debug Command Administrator</b>	CMC users who have the Debug Administrator privilege can execute system diagnostic commands.
<b>Fabric A Administrator</b>	CMC users who have the Fabric A Administrator privilege can set and configure the Fabric A IOM, which resides in either slot A1 or slot A2 of the I/O slots.
<b>Fabric B Administrator</b>	CMC users who have the Fabric B Administrator privilege can set and configure the Fabric B IOM, which resides in either slot B1 or slot B2 of the I/O slots.
<b>Fabric C Administrator</b>	CMC users who have the Fabric C Administrator privilege can set and configure the Fabric C IOM, which resides in either slot C1 or slot C2 of the I/O slots.

**Table 5-10. CMC Group Privileges**

<b>User Group</b>	<b>Privileges Granted</b>
CMC Group	Lists pre-defined user groups with assigned privileges: Administrator, Power User, Guest User, None, and Custom. <b>NOTE:</b> If you select Administrator, Power User, or Guest User, and then add or remove a privilege from the pre-defined set, the CMC Group automatically changes to Custom.
Administrator	<ul style="list-style-type: none"><li>• CMC Login User</li><li>• Chassis Configuration Administrator</li><li>• User Configuration Administrator</li><li>• Clear Logs Administrator</li><li>• Chassis Control Administrator (Power Commands)</li><li>• Super User</li><li>• Server Administrator</li><li>• Test Alert User</li><li>• Debug Command Administrator</li><li>• Fabric A Administrator</li><li>• Fabric B Administrator</li><li>• Fabric C Administrator</li></ul>
Power User	<ul style="list-style-type: none"><li>• CMC Login User</li><li>• Clear Logs Administrator</li><li>• Chassis Control Administrator (Power Commands)</li><li>• Server Administrator</li><li>• Test Alert User</li><li>• Fabric A Administrator</li><li>• Fabric B Administrator</li><li>• Fabric C Administrator</li></ul>
Guest User	CMC Login User



**Table 5-10. CMC Group Privileges (continued)**

User Group	Privileges Granted
Custom	Select any combination of the following permissions: <ul style="list-style-type: none"> <li>• CMC Login User</li> <li>• Chassis Configuration Administrator</li> <li>• User Configuration Administrator</li> <li>• Clear Logs Administrator</li> <li>• Chassis Control Administrator (Power Commands)</li> <li>• Super User</li> <li>• Server Administrator</li> <li>• Test Alert User</li> <li>• Debug Command Administrator</li> <li>• Fabric A Administrator</li> <li>• Fabric B Administrator</li> <li>• Fabric C Administrator</li> </ul>
None	No assigned permissions.

**Table 5-11. Comparison of Privileges Between CMC Administrators, Power Users, and Guest Users**

Privilege Set	Administrator Permissions	Power User Permissions	Guest User Permissions
CMC Login User	✓	✓	✓
Chassis Configuration Administrator	✓	✗	✗
User Configuration Administrator	✓	✗	✗
Clear Logs Administrator	✓	✓	✗
Chassis Control Administrator (Power Commands)	✓	✓	✗

**Table 5-11. Comparison of Privileges Between CMC Administrators, Power Users, and Guest Users (continued)**

Privilege Set	Administrator Permissions	Power User Permissions	Guest User Permissions
Super User	✓	✗	✗
Server Administrator	✓	✓	✗
Test Alert User	✓	✓	✗
Debug Command Administrator	✓	✗	✗
Fabric A Administrator	✓	✓	✗
Fabric B Administrator	✓	✓	✗
Fabric C Administrator	✓	✓	✗

### Adding and Managing Users

From the **Users** and **User Configuration** pages in the Web interface, you can view information about CMC users, add a new user, and change settings for an existing user.

You can configure up to 16 local users. If additional users are required and your company uses the Microsoft® Active Directory® service software, you can configure Active Directory to provide access to the CMC. Active Directory configuration would allow you to add and control CMC user privileges to your existing users in your Active Directory software, in addition to the 16 local users. For more information, see "Using the CMC With Microsoft Active Directory" on page 167.

Users can be logged in through Web interface, Telnet serial, SSH, and iKVM sessions. A maximum of 22 active sessions (Web interface, Telnet serial, SSH, and iKVM, in any combination) can be divided among users.

 **NOTE:** For added security, Dell strongly recommends that you change the default password of the root (User 1) account. The root account is the default administrative account that ships with the CMC. To change the default password for the root account, click **User ID 1** to open the **User Configuration** page. Help for that page is available through the Help link at the top right corner of the page.

To add and configure CMC users:

 **NOTE:** You must have **User Configuration Administrator** privilege to perform the following steps.

- 1 Log in to the Web interface.
- 2 Click the **Network/Security** tab, and then click the **Users sub-tab**. The **Users** page appears, listing each user's **user ID**, user name, CMC privilege, and **login state**, including those of the root user. User IDs available for configuration will have no user information displayed.
- 3 Click an available user ID number. The **User Configuration** page displays.

To refresh the contents of the **Users** page, click **Refresh**. To print the contents of the **Users** page, click **Print**.

- 4 Select general settings for the user.

Table 5-12 describes the **General** settings for configuring a new or existing CMC username and password.

**Table 5-12. General User Settings**

<b>Property</b>	<b>Description</b>
User ID	(Read only) Identifies a user by one of 16 preset, sequential numbers used for CLI scripting purposes. The User ID identifies the particular user when configuring the user through the CLI tool (RACADM). You cannot edit the User ID.  If you are editing information for user root, this field is static. You cannot edit the user name for root.
Enable User	Enables or disables the user's access to the CMC.

**Table 5-12. General User Settings (continued)**

Property	Description
User Name	Sets or displays the unique CMC user name associated with the user. The user name can contain up to 16 characters. CMC user names cannot include forward slash (/) or period (.) characters. <b>NOTE:</b> If you change the user name, the new name does not appear in the user interface until your next login. Any user logging in after you apply the new user name will be able to see the change immediately.
Change Password	Allows an existing user's password to be changed. Set the new password in the <b>New Password</b> field. The <b>Change Password</b> check box is not selectable if you are configuring a new user. You can select it only when changing an existing user setting.
Password	Sets a new password for an existing user. To change the password, you must also select the <b>Change Password</b> check box. The password can contain up to 20 characters, which display as dots as you type.
Confirm Password	Verifies the password you entered in the <b>New Password</b> field. <b>NOTE:</b> The <b>New Password</b> and <b>Confirm New Password</b> fields are editable only when you are (1) configuring a new user; or (2) editing the settings for an existing user, and the <b>Change Password</b> check box is selected.

- 5 Assign the user to a CMC user group. Table 5-9 describes CMC user privileges. Table 5-10 describes the **user group permissions** for the **CMC User Privileges** settings. Table 5-11 provides a comparison of privileges between Administrators, Power Users, and Guest Users.

When you select a user privilege setting from the CMC Group drop-down menu, the enabled privileges (shown as checked boxes in the list) display according to the pre-defined settings for that group.

You can customize the privileges settings for the user by checking or unchecking boxes. After you have selected a CMC Group or made Custom user privilege selections, click **Apply Changes** to keep the settings.

- 6 Click **Apply Changes**.

To refresh the contents of the **User Configuration** page, click **Refresh**.

To print the contents of the **User Configuration** page, click **Print**.

## Configuring and Managing Microsoft Active Directory Certificates



**NOTE:** To configure Active Directory settings for the CMC, you must have **Chassis Configuration Administrator** privilege.



**NOTE:** For more information about Active Directory configuration and how to configure Active Directory with Standard Schema or Extended Schema, see "Using the CMC With Microsoft Active Directory" on page 167.

You can use the Microsoft Active Directory service to configure your software to provide access to the CMC. Active Directory service allows you to add and control the CMC user privileges of your existing users.

To access the **Active Directory Main Menu** page:

- 1 Log in to the Web interface.
- 2 Click the **Network/Security** tab, and then click the **Active Directory** sub-tab. The **Active Directory Main Menu** page appears.

Table 5-13 lists the Active Directory Main Menu page options.

**Table 5-13. Active Directory Main Menu Page Options**

Field	Description
Configure	Configure and manage the following Active Directory settings for CMC: CMC Name, ROOT Domain Name, CMC Domain Name, Active Directory Authentication Timeout, Active Directory Schema Selection (Extended or Standard), and Role Group settings.
Upload AD Certificate	Upload a certificate authority-signed certificate for Active Directory to the CMC. This certificate, which you obtain from Active Directory, grants access to the CMC.

**Table 5-13. Active Directory Main Menu Page Options (continued)**

<b>Field</b>	<b>Description</b>
Download Certificate	Download a CMC server certificate to your management station or shared network using Windows Download Manager. When you select this option and click <b>Next</b> , a <b>File Download</b> dialog box appears. Use this dialog box to specify a location on your management station or shared network for the server certificate.
View Certificate	Displays the certificate authority-signed server certificate for Active Directory that has been uploaded to the CMC. <b>NOTE:</b> By default, CMC does not have a certificate authority-issued server certificate for Active Directory. You must upload a current, certificate authority-signed server certificate.

### **Configuring Active Directory (Standard Schema and Extended Schema)**



**NOTE:** To configure Active Directory settings for the CMC, you must have **Chassis Configuration Administrator** privilege.



**NOTE:** Before configuring or using the Active Directory feature, you must ensure that your Active Directory server is configured to communicate with the CMC.

- 1 Ensure that all Secure Socket Layer (SSL) certificates for the Active Directory servers are signed by the same certificate authority and have been uploaded to the CMC.
- 2 Log in to the Web interface and navigate to the **Active Directory Main Menu**.
- 3 Select **Configure**, and then click **Next**. The **Active Directory Configuration and Management** page displays.
- 4 Select the **Enable Active Directory** check box under the **Common Settings** heading.
- 5 Type the required information into the remaining fields. See Table 5-14.

**Table 5-14. Active Directory Common Settings Properties**

<b>Setting</b>	<b>Description</b>
Root Domain Name	<p>Specifies the domain name used by Active Directory. The root domain name is the fully qualified root domain name for the forest.</p> <p><b>NOTE:</b> The root domain name must be a valid domain name using the <i>x.y</i> naming convention, where <i>x</i> is a 1–256 character ASCII string with no spaces between characters, and <i>y</i> is a valid domain type such as com, edu, gov, int, mil, net, or org.</p> <p><b>Default:</b> null (empty)</p>
AD Timeout	<p>The time in seconds to wait for Active Directory queries to complete. The minimum value is equal to or greater than 15 seconds.</p> <p><b>Default:</b> 120 seconds</p>
Specify AD Server to search (Optional)	<p>Enables (when checked) directed call on the domain controller and global catalog. If you enable this option, you must also specify the domain controller and global catalog locations in the following settings.</p> <p><b>NOTE:</b> The name on the Active Directory CA Certificate will not be matched against the specified Active Directory server or the Global Catalog server.</p>
Domain Controller	<p>Specifies the server where your Active Directory service is installed.</p> <p>This option is valid only if <b>Specify AD Server to search (OPTIONAL)</b> is enabled.</p>
Global Catalog	<p>Specifies the location of the global catalog on the Active Directory domain controller. The global catalog provides a resource for searching an Active Directory forest.</p> <p>This option is valid only if <b>Specify AD Server to search (OPTIONAL)</b> is enabled.</p>

- 6 Select an Active Directory schema under the Active Directory Schema Selection heading. See Table 5-15.

- 7** If you selected **Extended Schema**, type the following required information in the Extended Schema Settings section, and then proceed directly to step 9. If you selected **Standard Schema**, proceed to step 8.
- **CMC Device Name** – The name that uniquely identifies the CMC card in Active Directory. The CMC name must be the same as the common name of the new CMC object you created in your Domain Controller. The name must be a 1–256 character ASCII string with no spaces between characters. Default: null (empty).
  - **CMC Domain Name** – The DNS name (string) of the domain where the Active Directory CMC object resides (example: cmc.com). The name must be a valid domain name consisting of x.y, where x is a 1–256 character ASCII string with no spaces between characters, and y is a valid domain type such as com, edu, gov, int, mil, net, or org. Default: null (empty).



**NOTE:** Do not use the NetBIOS name. The CMC Domain Name is the fully qualified domain name of the sub-domain where the CMC Device Object is located.

**Table 5-15. Active Directory Schema Options**

<b>Setting</b>	<b>Description</b>
Use Standard Schema	<p>Uses Standard Schema with Active Directory, which uses Active Directory group objects only.</p> <p>Before configuring CMC to use the Active Directory Standard Schema option, you must first configure the Active Directory software:</p> <ol style="list-style-type: none"> <li><b>1</b> On an Active Directory server (domain controller), open the Active Directory Users and Computers Snap-in.</li> <li><b>2</b> Create a group or select an existing group. The name of the group and the name of this domain must be configured on the CMC either with the Web interface or RACADM.</li> </ol>



**Table 5-15. Active Directory Schema Options (continued)**

<b>Setting</b>	<b>Description</b>
Use <b>Extended Schema</b>	Uses Extended Schema with Active Directory, which uses Dell-defined Active Directory objects.  Before configuring CMC to use the Active Directory Extended Schema option, you must first configure the Active Directory software: <ol style="list-style-type: none"><li><b>1</b> Extend the Active Directory schema.</li><li><b>2</b> Extend the Active Directory Users and Computers Snap-in.</li><li><b>3</b> Add CMC users and their privileges to Active Directory.</li><li><b>4</b> Enable SSL on each of your domain controllers.</li><li><b>5</b> Configure the CMC Active Directory properties using either the CMC Web interface or the RACADM.</li></ol>

- 8** If you selected Standard Schema, type the following information in the Standard Schema Settings section. If you selected Extended Schema, proceed to step 9.
- **Role Groups** – The role groups associated with the CMC. To change the settings for a role group, click the role group number in the Role Groups list. The **Configure Role Group** page displays.
-  **NOTE:** If you click a role group link prior to applying any new settings you have made, you will lose those settings. To avoid losing any new settings, click **Apply** before clicking a role group link.
- **Group Name** – The name that identifies the role group in the Active Directory associated with the CMC card.
  - **Group Domain** – The domain where the group is located.
  - **Group Privilege** – The privilege level for the group.
- 9** Click **Apply** to save the settings.

To refresh the contents of the **Active Directory Configuration and Management** page, click **Refresh**.

To print the contents of the **Active Directory Configuration and Management** page, click **Print**.

To configure the Role Groups for Active Directory, click the individual Role Group (1–5). See Table 5-10 and Table 5-9).

 **NOTE:** To save the settings on the **Active Directory Configuration and Management** page, you have to click **Apply** before proceeding to the **Custom Role Group** page.

## Uploading an Active Directory Certificate Authority-Signed Certificate

From the **Active Directory Main Menu** page:

- 1 Select **Upload AD Certificate**, and then click **Next**. The **Certificate Upload** page displays.
- 2 Type the file path in the text field, or click **Browse** to select the file.

 **NOTE:** The **File Path** value displays the relative file path of the certificate you are uploading. You must type the absolute file path, which includes the full path and the complete file name and file extension.

- 3 Click **Apply**. If the certificate is invalid, an error message displays.

To refresh the contents of the **Upload Active Directory CA Certificate** page, click **Refresh**.

To print the contents of the **Upload Active Directory CA Certificate** page, click **Print**.

## Viewing an Active Directory Certificate Authority-Signed Certificate

 **NOTE:** If you uploaded an Active Directory server certificate on the CMC, make sure the certificate is still valid and has not expired.

From the **Active Directory Main Menu** page:

- 1 Select **View Certificate**, and then click **Next**.
- 2 Click the appropriate **View Active Directory CA Certificate** page button to continue.

**Table 5-1. Active Directory CA Certificate Information**

Field	Description
Serial Number	Certificate serial number.
Subject Information	Certificate attributes entered by the subject.
Issuer Information	Certificate attributes returned by the issuer.

**Table 5-1. Active Directory CA Certificate Information (continued)**

<b>Field</b>	<b>Description</b>
Valid From	Certificate issue date.
Valid To	Certificate expiration date.

To refresh the contents of the **View Active Directory CA Certificate** page, click **Refresh**.

To print the contents of the **View Active Directory CA Certificate** page, click **Print**.

## **Securing CMC Communications Using SSL and Digital Certificates**

This subsection provides information about the following data security features that are incorporated in your CMC:

- Secure Sockets Layer (SSL)
- Certificate Signing Request (CSR)
- Accessing the SSL main menu
- Generating a new CSR
- Uploading a server certificate
- Viewing a server certificate

### **Secure Sockets Layer (SSL)**

The CMC includes a Web server that is configured to use the industry-standard SSL security protocol to transfer encrypted data over the Internet. Built upon public-key and private-key encryption technology, SSL is a widely accepted technique for providing authenticated and encrypted communication between clients and servers to prevent eavesdropping across a network.

SSL allows an SSL-enabled system to perform the following tasks:

- Authenticate itself to an SSL-enabled client
- Allow the client to authenticate itself to the server
- Allow both systems to establish an encrypted connection

This encryption process provides a high level of data protection. The CMC employs the 128-bit SSL encryption standard, the most secure form of encryption generally available for Internet browsers in North America.

The CMC Web server includes a Dell self-signed SSL digital certificate (Server ID). To ensure high security over the Internet, replace the Web server SSL certificate by submitting a request to the CMC to generate a new Certificate Signing Request (CSR).

### **Certificate Signing Request (CSR)**

A CSR is a digital request to a certificate authority (referred to as a CA in the Web interface) for a secure server certificate. Secure server certificates ensure the identity of a remote system and ensure that information exchanged with the remote system cannot be viewed or changed by others. To ensure the security for your CMC, it is strongly recommended that you generate a CSR, submit the CSR to a certificate authority, and upload the certificate returned from the certificate authority.

A certificate authority is a business entity that is recognized in the IT industry for meeting high standards of reliable screening, identification, and other important security criteria. Examples of CAs include Thawte and VeriSign. After the certificate authority receives your CSR, they review and verify the information the CSR contains. If the applicant meets the certificate authority's security standards, the certificate authority issues a certificate to the applicant that uniquely identifies that applicant for transactions over networks and on the Internet.

After the certificate authority approves the CSR and sends you a certificate, you must upload the certificate to the CMC firmware. The CSR information stored on the CMC firmware must match the information contained in the certificate.

### **Accessing the SSL Main Menu**



**NOTE:** To configure SSL settings for the CMC, you must have **Chassis Configuration Administrator** privilege.



**NOTE:** Any server certificate you upload must be current (not expired) and signed by a certificate authority.



- 1 Log in to the Web interface.
- 2 Click the **Network/Security** tab, and then click the **SSL sub-tab**. The **SSL Main Menu** page appears.

Use the **SSL Main Menu** page options to generate a CSR to send to a certificate authority. The CSR information is stored on the CMC firmware.

## Generating a New Certificate Signing Request

To ensure security, Dell strongly recommends that you obtain and upload a secure server certificate to the CMC. Secure server certificates ensure the identity of a remote system and that information exchanged with the remote system cannot be viewed or changed by others. Without a secure server certificate, the CMC is vulnerable to access from unauthorized users.

**Table 5-2. SSL Main Menu Options**

Field	Description
Generate a New Certificate Signing Request (CSR)	<p>Select this option and click <b>Next</b> to open the Generate Certificate Signing Request (CSR) page, where you can generate a CSR request for a secure Web certificate to submit to a certificate authority.</p> <p> <b>NOTICE:</b> Each new CSR overwrites any previous CSR on the CMC. For a certificate authority to accept your CSR, the CSR in the CMC must match the certificate returned from the certificate authority.</p>
Upload Server Certificate	<p>Select this option and click <b>Next</b> to open the Certificate Upload page, where you can upload an existing certificate that your company holds title to and uses to control access to the CMC.</p> <p> <b>NOTICE:</b> Only X509, Base 64-encoded certificates are accepted by the CMC. DER-encoded certificates are not accepted. Uploading a new certificate replaces the default certificate you received with your CMC.</p>
View Server Certificate	<p>Select the option and click the <b>Next</b> button to open the <b>View Server Certificate</b> page where you can view the current server certificate.</p>

To obtain a secure server certificate for the CMC, you must submit a Certificate Signing Request (CSR) to a certificate authority of your choice. A CSR is a digital request for a signed, secure server certificate containing information about your organization and a unique, identifying key.

When a CSR is generated from the **Generate Certificate Signing Request (CSR)** page, you are prompted to save a copy to your management station or shared network, and the unique information used to generate the CSR is stored on the CMC. This information is used later to authenticate the server certificate you receive from the certificate authority. After you receive the server certificate from the certificate authority, you must then upload it to the CMC.



**NOTE:** For the CMC to accept the server certificate returned by the certificate authority, authentication information contained in the new certificate must match the information that was stored on the CMC when the CSR was generated.



**NOTICE:** When a new CSR is generated, it overwrites any previous CSR on the CMC. If a pending CSR is overwritten before its server certificate is granted from a certificate authority, the CMC will not accept the server certificate because the information it uses to authenticate the certificate has been lost. Take caution when generating a CSR to prevent overwriting any pending CSR.

To generate a CSR:

- 1 From the **SSL Main Menu** page, select **Generate a New Certificate Signing Request (CSR)**, and then click **Next**. The **Generate Certificate Signing Request (CSR)** page displays.
- 2 Type a value for each CSR attribute value.  
Table 5-3 describes the **Generate Certificate Signing Request (CSR)** page options.
- 3 Click **Generate**. A **File Download** dialog box appears.
- 4 Save the `csr.txt` file to your management station or shared network. (You may also open the file at this time and save it later.) You will later submit this file to a certificate authority.

**Table 5-3. Generate Certificate Signing Request (CSR) Page Options**

<b>Field</b>	<b>Description</b>
<b>Common Name</b>	<p>The exact name being certified (usually the Web server's domain name, for example, <b>www.xyzcompany.com/</b>).</p> <p><b>Valid:</b> Alphanumeric characters (A–Z, a–z, 0–9); hyphens, underscores, and periods.</p> <p><b>Not valid:</b> Non-alphanumeric characters not noted above (such as, but not limited to, @ # \$ % &amp; *); characters used primarily in non-English languages, such as ß, â, é, ü.</p>
<b>Organization Name</b>	<p>The name associated with your organization (example: <b>XYZ Corporation</b>).</p> <p><b>Valid:</b> Alphanumeric characters (A–Z, a–z, 0–9); hyphens, underscores, periods, and spaces.</p> <p><b>Not valid:</b> Non-alphanumeric characters not noted above (such as, but not limited to, @ # \$ % &amp; *).</p>
<b>Organization Unit</b>	<p>The name associated with an organizational unit, such as a department (example: <b>Enterprise Group</b>).</p> <p><b>Valid:</b> Alphanumeric characters (A–Z, a–z, 0–9); hyphens, underscores, periods, and spaces.</p> <p><b>Not valid:</b> Non-alphanumeric characters not noted above (such as, but not limited to, @ # \$ % &amp; *).</p>
<b>Locality</b>	<p>The city or other location of your organization (examples: <b>Atlanta, Hong Kong</b>).</p> <p><b>Valid:</b> Alphanumeric characters (A–Z, a–z, 0–9) and spaces.</p> <p><b>Not Valid:</b> Non-alphanumeric characters not noted above (such as, but not limited to, @ # \$ % &amp; *).</p>
<b>State</b>	<p>The state, province, or territory where the entity that is applying for a certification is located (examples: <b>Texas, New South Wales, Andhra Pradesh</b>).</p> <p><b>NOTE: Do not use abbreviations.</b></p> <p><b>Valid:</b> Alphanumeric characters (upper- and lower-case letters; 0–9); and spaces.</p> <p><b>Not valid:</b> Non-alphanumeric characters not noted above (such as, but not limited to, @ # \$ % &amp; *).</p>

**Table 5-3. Generate Certificate Signing Request (CSR) Page Options (continued)**

Field	Description
Country	The country where the organization applying for certification is located.
Email	Your organization's e-mail address. You may type any e-mail address you want to have associated with the CSR. The e-mail address must be valid, containing the at (@) sign (example: name@xyzcompany.com).

### Uploading a Server Certificate

- 1 From the **SSL Main Menu** page, select **Upload Server Certificate**, and then click **Next**. The **Certificate Upload** page displays.
- 2 Type the file path in the text field, or click **Browse** to select the file.
- 3 Click **Apply**. If the certificate is invalid, an error message displays.



**NOTE:** The **File Path** value displays the relative file path of the certificate you are uploading. You must type the absolute file path, which includes the full path and the complete file name and file extension.

To refresh the contents of the **Certificate Upload** page, click **Refresh**.

To print the contents of the **Certificate Upload** page, click **Print**.

### Viewing a Server Certificate

From the **SSL Main Menu** page, select **View Server Certificate**, and then click **Next**. The **View Server Certificate** page displays.

Table 5-4 describes the fields and associated descriptions listed in the **Certificate** window.

**Table 5-4. Certificate Information**

Field	Description
Serial	Certificate serial number
Subject	Certificate attributes entered by the subject
Issuer	Certificate attributes returned by the issuer



**Table 5-4. Certificate Information (continued)**

Field	Description
notBefore	Issue date of the certificate
notAfter	Expiration date of the certificate

To refresh the contents of the **View Server Certificate** page, click **Refresh**.

To print the contents of the **View Server Certificate** page, click **Print**.

## Managing Sessions

The **Sessions** page displays all current instances of connections to the chassis and allows you to terminate any active session.



**NOTE:** To terminate a session, you must have **Chassis Configuration Administrator** privilege.

To manage sessions:

- 1 Log in to the CMC Web interface.
- 2 Select **Chassis** in the system tree.
- 3 Click the **Network/Security** tab.
- 4 Click the **Sessions** sub-tab. The **Sessions** page appears.

**Table 5-5. Sessions Properties**

Property	Description
Session ID	Displays the sequentially generated ID number for each instance of a login.
Username	Displays the user's login name (local user or Active Directory user). Examples of Active Directory user names are <i>name@domain.com</i> , <i>domain.com/name</i> , <i>domain.com\name</i> .
IP Address	Displays the user's IP address in dot-separated format.
Session Type	Describes the session type: Telnet, serial, SSH, Remote RACADM, SMASH CLP, WSMAN, or a GUI session.

**Table 5-5. Sessions Properties (continued)**

Property	Description
Terminate	Allows you to terminate any of the sessions listed, except for your own. To terminate the associated session, click the trash can icon  . This column is displayed only if you have Chassis Configuration Administrator privileges.

To terminate the session, click the trash can icon on the line that describes the session.

## Configuring Services

The CMC includes a Web server that is configured to use the industry-standard SSL security protocol to accept and transfer encrypted data from and to clients over the Internet. The Web server includes a Dell self-signed SSL digital certificate (Server ID) and is responsible for accepting and responding to secure HTTP requests from clients. This service is required by the Web interface and remote CLI tool for communicating to the CMC.

 **NOTE:** The remote (RACADM) CLI tool and the Web interface use the Web server. In the event that the Web Server is not active, the remote RACADM and the Web interface are not operable.

 **NOTE:** In an event of a Web server reset, wait at least one minute for the services to become available again. A Web server reset usually happens as a result of any of the following events: the network configuration or network security properties are changed through the CMC Web user interface or RACADM; the Web Server port configuration is changed through the Web user interface or RACADM; the CMC is reset; a new SSL server certificate is uploaded.

 **NOTE:** To modify service settings, you must have Chassis Configuration Administrator privilege.

To configure CMC services:

- 1 Log in to the CMC Web interface.
- 2 Click the Network/Security tab.
- 3 Click the Services sub-tab. The Services page appears.

- 4 Configure the following services as required:
  - CMC serial console (Table 5-6)
  - Web server (Table 5-7)
  - SSH (Table 5-8)
  - Telnet (Table 5-9)
  - Remote RACADM (Table 5-10)
- 5 Click **Apply Changes**; update all default time outs and maximum time out limits.

**Table 5-6. CMC Serial Console Settings**

<b>Setting</b>	<b>Description</b>
Enabled	Enables Telnet console interface on the CMC. <b>Default:</b> Unchecked (disabled)
Redirect Enabled	Enables the serial/text console redirection to the server through your Telnet client from the CMC. The CMC connects to iDRAC, which internally connects to the server. <b>Configuration options:</b> Checked (enabled), unchecked (disabled) <b>Default:</b> Unchecked (disabled)
Idle Timeout	Indicates the number of seconds before an idle Telnet session is automatically disconnected. A change to the <b>Timeout</b> setting takes effect at the next login; it does not affect the current session. <b>Timeout Range:</b> 60–1920 seconds. To disable the Timeout feature, enter 0. <b>Default:</b> 300 seconds
Baud Rate	Indicates the data speed on the external serial port on the CMC. <b>Configuration options:</b> 9600, 19200, 28800, 38400, 57600, and 115200 bps. <b>Default:</b> 115200 bps
Authentication Disabled	Enables CMC Serial Console login authentication. <b>Default:</b> Unchecked (disabled)

**Table 5-6. CMC Serial Console Settings (continued)**

Setting	Description
Escape Key	<p>Allows you to specify the Escape key combination that terminates serial/text console redirection when using the <code>connect com2</code> command.</p> <p><b>Default:</b> ^\ (Hold &lt;Ctrl&gt; and type a backslash (\) character)</p> <p> <b>NOTE:</b> The caret character ^ represents the &lt;Ctrl&gt; key.</p> <p>Configuration options:</p> <ul style="list-style-type: none"><li>• Decimal value (example: 95)</li><li>• Hexadecimal value (example: 0x12)</li><li>• Octal value (example: 007)</li><li>• ASCII value (example: ^a)</li></ul> <p>ASCII values may be represented using the following Escape key codes:</p> <ul style="list-style-type: none"><li>• Esc followed by any alphabetic character (a-z, A-Z)</li><li>• Esc followed by the following special characters: [ ] \ ^ _</li><li>• Maximum Allowed Length: 4</li></ul>
History Size Buffer	<p>Indicates the maximum size of the serial history buffer, which holds the last characters written to the Serial Console.</p> <p><b>Default:</b> 8192 characters</p>
Login Command	<p>Specifies the serial command that is automatically executed when a user logs into the CMC Serial Console interface.</p> <p><b>Example:</b> <code>connect server-1</code></p> <p><b>Default:</b> [Null]</p>

**Table 5-7. Web Server Settings**

<b>Setting</b>	<b>Description</b>
Enabled	Enables Web Server services (access through remote RACADM and the Web interface) for the CMC.  <b>Default:</b> Checked (enabled)
Max Sessions	Indicates the maximum number of simultaneous Web user interface sessions allowed for the chassis. A change to the <b>Max Sessions</b> property takes effect at the next login; it does not affect current <b>Active Sessions</b> (including your own). The remote RACADM is not affected by the <b>Max Sessions</b> property for the Web Server. <b>Allowed range:</b> 1–4 <b>Default:</b> 4 <b>NOTE:</b> If you change the <b>Max Sessions</b> property to a value less than the current number of <b>Active Sessions</b> and then log out, you cannot log back in until the other sessions have been terminated or expired.
Idle Timeout	Indicates the number of seconds before an idle Web user interface session is automatically disconnected. A change to the <b>Timeout</b> setting takes effect at the next login; it does not affect the current session. <b>Timeout range:</b> 60–1920 seconds <b>Default:</b> 1920 seconds

**Table 5-7. Web Server Settings (continued)**

Setting	Description
HTTP Port Number	<p>Indicates the default port used by the CMC that listens for a server connection.</p> <p><b>NOTE:</b> When you provide the HTTP address on the browser, the Web server automatically redirects and uses HTTPS.</p> <p>If the default HTTP port number (80) has been changed, you must include the port number in the address in the browser address field, as shown:</p> <p style="padding-left: 40px;"><code>http://&lt;IP address&gt;:&lt;port number&gt;</code></p> <p>where <i>IP address</i> is the IP address for the chassis, and <i>port number</i> is the HTTP port number other than the default of 80.</p> <p><b>Configuration range:</b> 10–65535</p> <p><b>Default:</b> 80</p>
HTTPS Port Number	<p>Indicates the default port used by the CMC that listens for a secured server connection.</p> <p>If the default HTTPS port number (443) has been changed, you must include the port number in the address in the browser address field, as shown:</p> <p style="padding-left: 40px;"><code>http://&lt;IP address&gt;:&lt;port number&gt;</code></p> <p>where <i>&lt;IP address&gt;</i> is the IP address for the chassis, and <i>&lt;port number&gt;</i> is the HTTPS port number other than the default of 443.</p> <p><b>Configuration range:</b> 10–65535</p> <p><b>Default:</b> 443</p>

**Table 5-8. SSH Settings**

<b>Setting</b>	<b>Description</b>
Enabled	Enables the SSH on the CMC. <b>Default:</b> Checked (enabled)
Max Sessions	The maximum number of simultaneous SSH sessions allowed for the chassis. A change to this property takes effect at the next login; it does not affect current Active Sessions (including your own). <b>Configurable range:</b> 1–4 <b>Default:</b> 4 <b>NOTE:</b> If you change the <b>Max Sessions</b> property to a value less than the current number of <b>Active Sessions</b> and then log out, you cannot log back in until the other sessions have been terminated or expired.
Idle Timeout	Indicates the number of seconds before an idle SSH session is automatically disconnected. A change to the <b>Timeout</b> setting takes effect at the next login; it does not affect the current session. <b>Timeout Range:</b> 60–1920 seconds. To disable the Timeout feature, enter 0. <b>Default:</b> 300 seconds
Port Number	Port used by the CMC that listens for a server connection. <b>Configuration range:</b> 10–65535 <b>Default:</b> 22

**Table 5-9. Telnet Settings**

<b>Setting</b>	<b>Description</b>
Enabled	Enables Telnet console interface on the CMC. <b>Default:</b> Unchecked (disabled)
Max Sessions	Indicates the maximum number of simultaneous Telnet sessions allowed for the chassis. A change to this property takes effect at the next login; it does not affect current Active Sessions (including your own). <b>Allowed range:</b> 1–4 <b>Default:</b> 4 <b>NOTE:</b> If you change the Max Sessions property to a value less than the current number of Active Sessions and then log out, you cannot log back in until the other sessions have been terminated or expired.
Idle Timeout	Indicates the number of seconds before an idle Telnet session is automatically disconnected. A change to the Timeout setting takes effect at the next login; it does not affect the current session. <b>Timeout Range:</b> 60–1920 seconds. To disable the Timeout feature, enter 0. <b>Default:</b> 0 seconds (disabled)
Port Number	Indicates the port used by the CMC that listens for a server connection. <b>Default:</b> 23



**Table 5-10. Remote RACADM Settings**

<b>Setting</b>	<b>Description</b>
Enabled	Enables the remote RACADM utility access to the CMC. <b>Default:</b> Checked (enabled)
Max Sessions	Indicates the maximum number of simultaneous RACADM sessions allowed for the chassis. A change to this property takes effect at the next login; it does not affect current <b>Active Sessions</b> (including your own). <b>Allowed range:</b> 1–4 <b>Default:</b> 4 <b>NOTE:</b> If you change the Max Sessions property to a value less than the current number of Active Sessions and then log out, you cannot log back in until the other sessions have been terminated or expired.
Idle Timeout	Indicates the number of seconds before an idle racadm session is automatically disconnected. A change to the Idle Timeout setting takes effect at the next login; it does not affect the current session. To disable the Idle Timeout feature, enter 0. <b>Default:</b> 300 seconds

## Configuring Power Budgeting

The CMC allows you to budget and manage power to the chassis. The power management service optimizes power consumption and re-allocates power to different modules based on the demand.

For instructions on configuring power through the CMC, see "Configuring and Managing Power" on page 205.

For more information on the CMC's power management service, see "Power Management" on page 197.

# Managing Firmware

This section describes how to use the Web interface to update CMC firmware. When you update firmware, there is a recommended process to follow that can prevent a loss of service if the update fails. See "Installing or Updating the CMC Firmware" on page 48 for guidelines to follow before you use the instructions in this section.

## Viewing the Current Firmware Versions

The **Updatable Components** page displays the current version of the iKVM firmware, primary CMC firmware, and (if applicable) the standby CMC firmware.

If the chassis contains a server whose iDRAC is in recovery mode or if the CMC detects that an iDRAC has corrupted firmware, the iDRAC is also listed on the **Updatable Components** page. See "Recovering iDRAC Firmware Using the CMC" on page 140 for the steps to recover iDRAC firmware using the CMC.

To view firmware versions:

- 1 Log in to the Web interface (see "Accessing the CMC Web Interface" on page 87).
- 2 Click **Chassis** in the system tree.
- 3 Click the **Update** tab. The **Updatable Components** page appears.

## Updating CMC and iKVM Firmware



**NOTE:** To update firmware on the CMC, you must have **Chassis Configuration Administrator** privilege.



**NOTE:** The firmware update retains the current CMC and iKVM settings.





**NOTE:** The firmware update is supported for CMC and iKVM firmware only. The iDRAC firmware is updatable through the iDRAC Web-based user interface or remote RACADM. However, if the CMC user interface detects the presence of a server but is unable to communicate with it, it indicates a corruption. In such cases, iDRAC Firmware Update will be available from the **Updatable Components** page. To open the **Updatable Components** page, select **Chassis** in the system tree, and then click the **Update** tab.

The **Updatable Components** page displays the current version of the firmware for each listed component (CMC/iKVM) and allows you to update the firmware to the latest revision by uploading the firmware image file (package).

 **NOTE:** Be sure you have the latest firmware version. You can download the latest firmware image file from the **Dell Support** website.

### Updating the CMC Firmware

 **NOTE:** During updates of the CMC firmware or the iDRAC firmware on a server, some or all of the fan units in the chassis will spin at 100%. This is normal.

 **NOTE:** The CMC resets and becomes temporarily unavailable after the firmware has been uploaded successfully. To avoid disconnecting other users during a reset, notify authorized users who might log into the CMC and check for active sessions by viewing the **Sessions** page. To open the **Sessions** page, select **Chassis** in the tree, click the **Network/Security** tab, and then click the **Sessions** sub-tab. Help for that page is available through the **Help** link at the top right corner of the page.

 **NOTE:** When transferring files to and from the CMC, the file transfer icon spins during the transfer. If your icon is not animated, make sure that your browser is configured to allow animations. See "Allow Animations in Internet Explorer" on page 38 for instructions.

 **NOTE:** If you experience problems downloading files from CMC using Internet Explorer, enable the **Do not save encrypted pages to disk** option. See "Downloading Files From CMC With Internet Explorer" on page 38 for instructions.

- 1 On the **Updatable Components** page, click the CMC name. The **Firmware Update** page appears.
- 2 In the **Value** field, type the path on your management station or shared network where the firmware image file resides, or click **Browse** to navigate to the file location.
- 3 Click **Update**. A dialog box appears asking you to confirm the action.
- 4 Click **Yes** to continue. The firmware transfer process will begin and the status will display the message "Firmware Update in Progress". Once the CMC update is complete, the CMC will be reset. Once the reset is complete, you will need to refresh the User Interface page to then log in again.

## Updating the iKVM Firmware



**NOTE:** The iKVM resets and becomes temporarily unavailable after the firmware has been uploaded successfully.

- 1 Log back in to the CMC Web interface.
- 2 Select **Chassis** in the system tree.
- 3 Click the **Update** tab. The **Updatable Components** page appears.
- 4 Click the iKVM name. The **Firmware Update** page appears.
- 5 In the **Value** field, type the path on your management station or shared network where the firmware image file resides, or click **Browse** to navigate to the file location.



**NOTE:** The default iKVM firmware image name is **ikvm.bin**. However, the iKVM firmware image name can be renamed. If you are unable to locate **ikvm.bin**, determine whether another user has renamed the file.

- 6 Click **Update**. A dialog box appears asking you to confirm the action.
- 7 Click **Yes** to continue.

When the update is complete, iKVM resets.

## Recovering iDRAC Firmware Using the CMC

iDRAC firmware is typically updated using iDRAC facilities such as the iDRAC Web interface, the SM-CLP command line interface, or operating system specific update packages downloaded from [support.dell.com](http://support.dell.com). See the *iDRAC Firmware User's Guide* for instructions for updating the iDRAC firmware.

If the iDRAC firmware becomes corrupted, as could occur if the iDRAC firmware update progress is interrupted before it completes, you can use the CMC Web interface to update its firmware.

If the CMC detects the corrupted iDRAC firmware, the iDRAC is listed on the **Updatable Components** page. See "Viewing the Current Firmware Versions" on page 138 for instructions to display the **Updatable Components** page.



**NOTE:** If the iDRAC MAC address has been lost or corrupted, it must be set to a valid address before you can recover the iDRAC firmware using the CMC. You can use the `IPMI config params` command to set a MAC address. The MAC address is the fifth parameter of the command. It must be set to a 6-byte address that is unique on your management network. Refer to the documentation for your IPMI utility (for example, `ipmitool` or `ipmish`) for help executing the command.

Follow these steps to update the iDRAC firmware.

- 1 Download the latest iDRAC firmware to your management computer from [support.dell.com](http://support.dell.com).
- 2 Log in to the Web interface (see "Accessing the CMC Web Interface" on page 87).
- 3 Click **Chassis** in the system tree.
- 4 Click the **Update** tab. The **Updatable Components** page appears. The server with the recoverable iDRAC is included in the list if it is able to be recovered from the CMC.
- 5 Click **server-*n***, where *n* is the number of the server whose iDRAC you want to recover.
- 6 Click **Browse**, browse to the iDRAC firmware image you downloaded, and click **Open**.



**NOTE:** The default iDRAC firmware image name is `firmimg.imc`.

- 7 Click **Begin Firmware Update**.



**NOTE:** It can take up to ten minutes to update the iDRAC firmware. The file transfer icon spins while the firmware image is transferred to the CMC, but not while the CMC transfers the image to the iDRAC.

After the firmware image file has been uploaded to the CMC, the iDRAC will update itself with the image.

## FlexAddress

This section describes the FlexAddress feature Web interface screens.

FlexAddress is an optional upgrade in CMC 1.1 that allows server modules to replace the factory assigned World Wide Name/Media Access Control (WWN/MAC) ID with a WWN/MAC ID provided by the chassis.

 **NOTE:** You must purchase and install the FlexAddress upgrade to have access to the configuration screens. If the upgrade has not been purchased and installed, the following text will be displayed on the Web interface:

Optional feature not installed. See the *Dell Chassis Management Controller Users Guide* for information on the chassis-based WWN and MAC address administration feature.

To purchase this feature, please contact Dell at [www.dell.com](http://www.dell.com).

## Viewing FlexAddress Status

You can use the Web interface to view FlexAddress status information. You can view status information for the entire chassis or for an individual server. The information displayed includes:

- Fabric configuration
- Whether FlexAddress is enabled
- Slot number and name
- Chassis-assigned and server-assigned addresses
- Addresses in use

 **NOTE:** You can also view FlexAddress status using the command line interface. For more command information, see "Using FlexAddress" on page 151.

## Viewing Chassis FlexAddress Status

FlexAddress status information can be displayed for the entire chassis. The status information includes whether the feature is active and an overview of the FlexAddress status for each blade.

Use the following steps to view whether FlexAddress is active for the chassis:

- 1 Log in to the Web interface (see "Accessing the CMC Web Interface" on page 87).
- 2 Click **Chassis** in the system tree.
- 3 Click the **Setup** tab. The **General Setup** page appears. The FlexAddress entry will have a value of **Active** or **Not Active**; a value of active means that the feature is installed and in use on the chassis. A value of not active means that the feature is not installed and not in use on the chassis.

Use the following steps to display a FlexAddress status overview for each server module:

- 1** Log in to the Web interface (see "Accessing the CMC Web Interface" on page 87).
- 2** Click **Servers** in the system tree. Click the **Properties** tab, **FlexAddress** sub-tab.
- 3** The FlexAddress Summary page is displayed. This page allows you to view the WWN configuration and MAC addresses for all slots in the chassis.

The status page presents the following information:

Fabric Configuration	<b>Fabric A</b> , <b>Fabric B</b> , and <b>Fabric C</b> display the type of the Input/Output fabric installed.
WWN/MAC Addresses	<p>Displays FlexAddress configuration for each slot in the chassis. Information displayed includes:</p> <ul style="list-style-type: none"> <li>• Slot number and location</li> <li>• Whether FlexAddress is enabled</li> <li>• Fabric type</li> <li>• Server-assigned and chassis-assigned WWN/MAC addresses.</li> </ul> <p>A green check mark indicates the active address type, either server-assigned or chassis-assigned.</p>

- 4** For additional information, review the online help page by clicking the **Help** link and review "Using FlexAddress" on page 151.

### Viewing Server FlexAddress Status

FlexAddress status information can also be displayed for each individual server. The server level information displays a FlexAddress status overview for that blade.

Use the following steps to view FlexAddress server information:

- 1 Log in to the Web interface (see "Accessing the CMC Web Interface" on page 87).
- 2 Expand **Servers** in the system tree. All of the servers (1–16) appear in the expanded **Servers** list.
- 3 Click the server you want to view. The **Server Status** page displays.
- 4 Click the **Setup** tab, and the **FlexAddress** sub-tab. The FlexAddress status page is displayed. This page allows you to view the WWN configuration and MAC addresses for the selected server.

The status page presents the following information:

FlexAddress Enabled	Displays whether the FlexAddress feature is enabled or disabled for the particular slot.
Current State	Displays the current FlexAddress configuration: <ul style="list-style-type: none"> <li>• <b>Chassis-Assigned</b> - selected slot address is chassis assigned using the FlexAddress. The slot-based WWN/MAC addresses remain the same even if a new server is installed.</li> <li>• <b>Server-Assigned</b> - server uses the server-assigned address or the default address embedded into the controller hardware.</li> </ul>
Power State	Displays the current power status of the servers; values are: <b>On, Powering On, Powering Off, Off</b> , and N/A (if a server is not present).
BIOS Version	Displays the current BIOS version of the server module.
Location	Displays the location of the Input/Output (I/O) module in the chassis by group number (A, B, or C) and slot number (1 or 2). Slot names: A1, A2, B1, B2, C1, or C2.



Fabric	Displays the type of fabric.
Server-Assigned	Displays the server-assigned WWN/MAC addresses that are embedded in the controller's hardware.
Chassis-Assigned	Displays the chassis-assigned WWN/MAC addresses that are used for the particular slot.

- 5 For additional information, review the online help page by clicking the **Help** link and review "Using FlexAddress" on page 151.

## Configuring FlexAddress

If you purchase FlexAddress with your chassis, it will be installed and active when you power up your system. If you purchase FlexAddress separately, you must install the SD feature card using the instructions in the *Chassis Management Controller (CMC) Secure Digital (SD) Card Technical Specification* document. See [support.dell.com](http://support.dell.com) for this document.

The server must be off before you begin configuration. You can enable or disable FlexAddress on a per fabric basis. Additionally, you can enable/disable the feature on a per slot basis. Once you enable the feature on a per-fabric basis, you can then select slots to be enabled. For example, if Fabric-A is enabled, any slots that are enabled will have FlexAddress enabled only on Fabric-A. All other fabrics will use the factory-assigned WWN/MAC on the server.

Selected slots will be FlexAddress enabled for all fabrics that are enabled. For example, it is not possible to enable Fabric-A and B, and have Slot 1 be FlexAddress enabled on Fabric-A but not on Fabric-B.



**NOTE:** You can also configure FlexAddress using the command line interface. For more command information, see "Using FlexAddress" on page 151.

## Chassis-Level Fabric and Slot FlexAddress Configuration

At the chassis level, you can enable or disable the FlexAddress feature for fabrics and slots. FlexAddress is enabled on a per-fabric basis and then slots will be selected for participation in the feature. Both fabrics and slots must be enabled to successfully configure FlexAddress.

Perform the following steps to enable or disable fabrics and slots to use the FlexAddress feature:

- 1 Log on to the Web interface (see "Accessing the CMC Web Interface" on page 87).
- 2 Click **Servers** in the system tree.
- 3 Click the **Setup** tab. The **General Setup** page appears. Click **Deploy FlexAddress**. The Deploy FlexAddress screen is displayed.
- 4 The **Select Fabrics for Chassis-Assigned WWN/MACs** displays a check box for **Fabric A**, **Fabric B**, and **Fabric C**.
- 5 Click the check box for each fabric you want to enable FlexAddress on. To disable a fabric, click the check box to clear the selection.



**NOTE:** If no fabrics are selected, FlexAddress will not be enabled for the selected slots.

The **Select Slots for Chassis-Assigned WWN/MACs** displays an **Enabled** check box for each slot in the chassis (1 - 16).

- 6 Click the **Enabled** check box for each slot you want to enable FlexAddress on. If you want to select all slots, use the **Select/Deselect All** check box. To disable a slot, click the **Enabled** check box to clear the selection.



**NOTE:** If a blade is present in the slot, it needs to be powered off before the FlexAddress feature can be enabled on that slot.



**NOTE:** If no slots are selected, FlexAddress will not be enabled for the selected fabrics.

- 7 Click **Apply** to save the changes.
- 8 For additional information, click the **Help** link and review "Using FlexAddress" on page 151.

## Server-Level Slot FlexAddress Configuration

At the server level, you can enable or disable the FlexAddress feature for individual slots.

Use the following steps to enable or disable an individual slot to use the FlexAddress feature:

- 1** Log in to the Web interface (see "Accessing the CMC Web Interface" on page 87).
- 2** Expand **Servers** in the system tree. All of the servers (1–16) appear in the expanded **Servers** list.
- 3** Click the server you want to view. The **Server Status** page displays.
- 4** Click the **Setup** tab, and the **FlexAddress** sub-tab. The FlexAddress status page is displayed.
- 5** Use the pull down menu for **FlexAddress Enabled** to make your selection; select **Yes** to enable FlexAddress or select **No** to disable FlexAddress.
- 6** Click **Apply** to save the changes.
- 7** For additional information, click the **Help** link and review "Using FlexAddress" on page 151.

# Frequently Asked Questions

Table 5-11 lists frequently asked questions and answers.

**Table 5-11. Managing and Recovering a Remote System: Frequently Asked Questions**

Question	Answer
When accessing the CMC Web interface, I get a security warning stating the host name of the SSL certificate does not match the host name of the CMC.	<p>The CMC includes a default CMC server certificate to ensure network security for the Web interface and remote RACADM features. When this certificate is used, the Web browser displays a security warning because the default certificate is issued to <b>CMC default certificate</b> which does not match the host name of the CMC (for example, the IP address).</p> <p>To address this security concern, upload a CMC server certificate issued to the IP address of the CMC. When generating the certificate signing request (CSR) to be used for issuing the certificate, ensure that the common name (CN) of the CSR matches the IP address of the CMC (for example, 192.168.0.120) or the registered DNS CMC name.</p> <p>To ensure that the CSR matches the registered DNS CMC name:</p> <ol style="list-style-type: none"><li>1 In the <b>System</b> tree, click <b>Chassis</b>.</li><li>2 Click the <b>Network/Security</b> tab, and then click <b>Configuration</b>. The <b>Network Configuration</b> page appears.</li><li>3 Select the <b>Register CMC on DNS</b> check box.</li><li>4 Enter the CMC name In the <b>DNS CMC Name</b> field.</li><li>5 Click <b>Apply Changes</b>.</li></ol> <p>For more information about generating CSRs and issuing certificates, see "Securing CMC Communications Using SSL and Digital Certificates" on page 123.</p>

**Table 5-11. Managing and Recovering a Remote System: Frequently Asked Questions (continued)**

Question	Answer
Why are the remote RACADM and Web-based services unavailable after a property change?	<p>It may take a minute for the remote RACADM services and the Web interface to become available after the CMC Web server resets.</p> <p>The CMC Web server is reset after the following occurrences:</p> <ul style="list-style-type: none"><li>• When changing the network configuration or network security properties using the CMC Web user interface</li><li>• When the <code>cfgRacTuneHttpsPort</code> property is changed (including when a <code>config -f &lt;config file&gt;</code> changes it)</li><li>• When <code>racresetcfg</code> is used</li><li>• When the CMC is reset</li><li>• When a new SSL server certificate is uploaded</li></ul>
Why doesn't my DNS server register my CMC?	<p>Some DNS servers only register names of 31 characters or fewer.</p>
When accessing the CMC Web interface, I get a security warning stating the SSL certificate was issued by a certificate authority that is not trusted.	<p>CMC includes a default CMC server certificate to ensure network security for the Web interface and remote RACADM features. This certificate is <i>not</i> issued by a trusted certificate authority. To address this security concern, upload a CMC server certificate issued by a trusted certificate authority (such as Thawte or Verisign). For more information about issuing certificates, see "Securing CMC Communications Using SSL and Digital Certificates" on page 123.</p>

**Table 5-11. Managing and Recovering a Remote System: Frequently Asked Questions (*continued*)**

Question	Answer
The following message is displayed for unknown reasons: Remote Access: SNMP Authentication Failure Why does this happen?	<p data-bbox="460 312 960 571">As part of discovery, IT Assistant attempts to verify the device's get and set community names. In IT Assistant, you have the get <b>community name = public</b> and the set <b>community name = private</b>. By default, the community name for the CMC agent is public. When IT Assistant sends out a set request, the CMC agent generates the SNMP authentication error because it will only accept requests from <b>community = public</b>.</p> <p data-bbox="460 587 960 639">You can change the CMC community name using RACADM.</p> <p data-bbox="460 655 960 708">To see the CMC community name, use the following command:</p> <pre data-bbox="460 724 960 751">racadm getconfig -g cfgOobSnmp</pre> <p data-bbox="460 767 960 820">To set the CMC community name, use the following command:</p> <pre data-bbox="460 836 960 927">racadm config -g cfgOobSnmp -o cfgOobSnmpAgentCommunity &lt;community name&gt;</pre> <p data-bbox="460 943 960 1129">To prevent SNMP authentication traps from being generated, you must input community names that will be accepted by the agent. Since the CMC only allows one community name, you must input the same <b>get</b> and <b>set</b> community name for IT Assistant discovery setup.</p>

## Troubleshooting the CMC

The CMC Web interface provides tools for identifying, diagnosing, and fixing problems with your chassis. For more information about troubleshooting, see "Troubleshooting and Recovery" on page 259.

## Using FlexAddress

The FlexAddress feature is an optional upgrade in CMC 1.1 that allows server modules to replace the factory assigned World Wide Name/Media Access Control (WWN/MAC) ID with a WWN/MAC ID provided by the chassis.

Every server module is assigned a unique WWN/MAC ID as part of the manufacturing process. If you have to replace one server module with another, the WWN/MAC ID will change and Ethernet network management tools and SAN resources must be reconfigured to be aware of the new server module.

FlexAddress allows the CMC to assign the WWN/MAC ID to a particular slot and *overrides* the factory ID. If the server module is replaced, the slot-based WWN/MAC ID remains the same. This eliminates the need to reconfigure Ethernet network management tools and SAN resources for a new server module.

Additionally, the *override* action only occurs when a server module is inserted in a FlexAddress enabled chassis; no permanent changes are made to the server module. If a server module is moved to a chassis that does not support FlexAddress, the factory assigned WWN/MAC ID will be used.

Prior to installing FlexAddress, you can determine the range of MAC addresses contained on their FlexAddress feature card by inserting the SD card into an USB "Memory Card Reader" and viewing the file "pwwn\_mac.xml". The clear text XML file on the SD card will contain an XML tag "mac\_start" that is the first starting hex MAC address that will be used for this unique MAC address range. The "mac\_count" tag is the total number of MAC addresses that the SD card allocates. The total MAC range allocated can be determined by:

"mac\_start" + 0xCF (208 - 1) = mac\_end

For example:(starting\_mac)00188BFFDCFA + 0xCF =  
(ending\_mac)00188BFFDDC9



**NOTE:** You should lock the SD card prior to inserting in the USB "Memory Card Reader" to prevent accidentally modifying any of the contents. You **MUST UNLOCK** the SD card before inserting into the CMC.

# Activating FlexAddress

FlexAddress is delivered on a Secure Digital (SD) card that must be inserted into the CMC to provide the chassis-assigned WWN/MAC IDs. To activate the FlexAddress feature there are several required updates; **if you are not activating FlexAddress these updates are not required.** The updates include server module BIOS, I/O mezzanine BIOS or firmware, and CMC firmware. You must apply these updates before you enable FlexAddress. If these updates are not applied, the FlexAddress feature may not function as expected.

Component	Minimum required version
Ethernet mezzanine card - Broadcom M5708t	Boot code firmware 4.4.1 or later iSCSI boot firmware 2.7.11 or later PXE firmware 4.4.3 or later
FC mezzanine card - QLogic QME2472	BIOS 2.04 or later
FC mezzanine card - Emulex LPe1105-M4	BIOS 3.03a3 and firmware 2.72A2 or later
Server Module BIOS	(PowerEdge™ M600) BIOS 2.02 or later (PowerEdge™ M605) BIOS 2.03 or later
PowerEdge™ M600/M605 LAN on motherboard (LOM)	Boot code firmware 4.4.1 or later iSCSI boot firmware 2.7.11 or later
iDRAC	Version 1.11 or later
CMC	Version 1.10 or later

To ensure proper deployment of the FlexAddress feature, update the BIOS and the firmware in the following order:

- 1 Update all mezzanine card firmware and BIOS.
- 2 Update server module BIOS.
- 3 Update iDRAC firmware on the server module.
- 4 Update all CMC firmware in the chassis; if redundant CMCs are present, ensure both are updated.
- 5 Insert the SD card into the passive module for a redundant CMC module system or into the single CMC module for a non-redundant system.



**NOTE:** If the firmware or BIOS that supports FlexAddress is not installed, you will see an error on the server health page and FlexAddress will not be activated.



See the *Chassis Management Controller (CMC) Secure Digital (SD) Card Technical Specification* document for SD card installation instructions.



**NOTE:** The SD card contains a FlexAddress feature. Data contained on the SD card is encrypted and may not be duplicated or altered in any way as it may inhibit system function and cause the system to malfunction.



**NOTE:** Your use of the SD card is limited to one chassis only. If you have multiple chassis, you must purchase additional SD cards.

Activation of the FlexAddress feature is automatic upon restart of the CMC with the SD feature card installed; this will cause the feature to bind to the current chassis. If you have the SD card installed on the redundant CMC system, activation of the FlexAddress feature will not occur until the redundant CMC is made active. See the *Chassis Management Controller (CMC) Secure Digital (SD) Card Technical Specification* document for information on how to make a redundant CMC active.

Once the CMC restarts, verify the activation process by using the steps in "Verifying FlexAddress Activation."

## Verifying FlexAddress Activation

To ensure proper activation of FlexAddress, RACADM commands can be used to verify the SD card installation and a second command to verify FlexAddress activation.

Use the following RACADM command to verify the SD card installation and status:

```
racadm featurecard -s
```

The following table lists the status messages returned by the command.

**Table 6-1. Status Messages Returned by featurecard -s Command**

Status Message	Actions
No feature card inserted.	Check the CMC to verify that the SD card was properly inserted. In a redundant CMC configuration, make sure the CMC with the SD feature card installed is the active CMC and not the standby CMC.
The feature card inserted is valid and contains the following feature(s) FlexAddress: The feature card is bound to this chassis.	No action required.
The feature card inserted is valid and contains the following feature(s) FlexAddress: The feature card is bound to another chassis, svctag = ABC1234, SD card SN = 01122334455	Remove the SD card; locate and install the SD card for the current chassis.
The feature card inserted is valid and contains the following feature(s) FlexAddress: The feature card is not bound to any chassis.	The feature card can be moved to another chassis, or can be reactivated on the current chassis. To reactivate on the current chassis, enter <i>racadm racreset</i> until the CMC module with the feature card installed becomes active.

Use the following RACADM command to display all activated features on the chassis:

```
racadm feature -s
```

The command will return the following status message:

```
Feature = FlexAddress
```

```
Date Activated = 8 April 2008 - 10:39:40
```

```
Feature installed from SD card SN = 01122334455
```

If there are no active features on the chassis, the command will return an error message:

```
racadm feature -s
```

```
No features are activated on this chassis.
```

Once you have run both commands, FlexAddress feature activation is verified. For further information on the RACADM commands, see "feature" on page 294 and "featurecard" on page 295.

## Deactivating FlexAddress

The FlexAddress feature can be deactivated and the SD card returned to a pre-installation state using a RACADM command. There is no deactivation function within the Web interface. Deactivation will return the SD card to its original state where it can be installed and activated on a different chassis.



**NOTICE:** The SD card must be physically installed in the CMC, and the chassis must be powered-down before executing the deactivation command.

If you execute the deactivation command with no card installed, or with a card from a different chassis installed, the feature will be deactivated and no change will be made to the card.

### Deactivating FlexAddress

Use the following RACADM command to deactivate the FlexAddress feature and restore the SD card:

```
racadm feature -d -c flexaddress
```

The command will return the following status message upon successful deactivation:

```
feature FlexAddress is deactivated on the chassis successfully.
```

If the chassis is not powered-down prior to execution, the command will fail with the following error message:

```
ERROR: Unable to deactivate the feature because the chassis is powered ON
```

For further information on the command, see "feature" on page 294.

## Viewing FlexAddress Status Using the CLI

You can use the command line interface to view FlexAddress status information. You can view status information for the entire chassis or for a particular slot. The information displayed includes:

- Fabric configuration
- FlexAddress enabled/disabled
- Slot number and name
- Chassis-assigned and server-assigned addresses
- Addresses in use.

Use the following RACADM command to display FlexAddress status for the entire chassis:

```
racadm getflexaddr
```

To display FlexAddress status for a particular slot:

```
racadm getflexaddr [-i <slot#>]
```

```
<slot#> = 1 to 16
```

Refer to "Configuring FlexAddress" for additional details on FlexAddress configuration.

If the command is run without FlexAddress activated, it will return the following error message:

```
This feature is not available on this chassis.
```

For additional information on the command, see "getflexaddr" on page 303.

## Configuring FlexAddress Using the CLI

You can use the command line interface to enable or disable FlexAddress on a per fabric basis. Additionally, you can enable/disable the feature on a per slot basis. Once you enable the feature on a per-fabric basis, you can then select slots to be enabled. For example, if Fabric-A is enabled, any slots that are enabled will have FlexAddress enabled only on Fabric-A. All other fabrics will use the factory-assigned WWN/MAC on the server.

Enabled slots will be FlexAddress enabled for all fabrics that are enabled. For example, it is not possible to enable Fabric-A and B, and have Slot 1 be FlexAddress enabled on Fabric-A but not on Fabric-B.

Use the following RACADM command to enable or disable fabrics:

```
racadm setflexaddr [-f <fabricName> <state>]
```

<fabricName> = A, B, C

<state> = 0 or 1

Where 0 is disable and 1 is enable.

Use the following RACADM command to enable or disable slots:

```
racadm setflexaddr [-i <slot#> <state>]
```

<slot#> = 1 to 16

<state> = 0 or 1

Where 0 is disable and 1 is enable.

For additional information on the command, see "setflexaddr" on page 333.

## **Additional FlexAddress Configuration for Linux**

When changing from a server-assigned MAC to chassis-assigned MAC on Linux-based operating systems, additional configuration steps may be required:

- SLES 9 and SLES 10: Users may need to run YAST (Yet another Setup Tool) on their Linux system to configure their network devices and then restart the network services.
- RHEL 4 and RHEL 5: Users will need to run Kudzu, a utility to detect and configure new/changed hardware on the system. Kudzu will present the user with The Hardware Discovery Menu, it will detect the MAC address change as Hardware was removed and new Hardware added.

## **Wake-On-LAN with FlexAddress**

When the FlexAddress feature is deployed for the first time on a given server module, it requires a power-down and power-up sequence for FlexAddress to take effect. FlexAddress on Ethernet devices is programmed by the server module BIOS. In order for the server module BIOS to program the address, it

needs to be operational which requires the server module to be powered up. Once the power-down and power-up sequence completes, the FlexAddress feature is available for Wake-On-LAN (WOL) function.

## Troubleshooting FlexAddress

This section contains troubleshooting information for FlexAddress.

- 1 If a feature card is removed, what will happen?

Nothing will happen. Feature cards can be removed and stored or may be left in place.

- 2 If a feature card that was used in one chassis is removed and put into another chassis, what will happen?

The Web interface will display an error that states:

This feature card was activated with a different chassis. It must be removed before accessing the FlexAddress feature.

```
Current Chassis Service Tag = XXXXXXXX
```

```
Feature Card Chassis Service Tag = YYYYYYYY
```

An entry will be added to the CMC log that states:

```
cmc <date timestamp> : feature  
'FlexAddress@XXXXXXX' not activated; chassis ID=  
'YYYYYYY'
```

- 3 What happens if the feature card is removed and a non-FlexAddress card is installed?

No activation or modifications to the card should occur. The card will be ignored by CMC. In this situation, the `$racadm featurecard -s` will return a message of:

```
No feature card inserted
```

```
ERROR: can't open file
```

- 4 If the chassis service tag is reprogrammed, what happens if there is a feature card bound to that chassis?

The Web interface will display an error that states:

```
This feature card was activated with a different
chassis. It must be removed before accessing the
FlexAddress feature.
```

```
Current Chassis Service Tag = XXXXXXXXX
```

```
Feature Card Chassis Service Tag = YYYYYYYY
```

Dell Service will need to program the original chassis service tag back into the chassis and reset the CMC.

- 5 What if I have two feature cards installed in my redundant CMC system? Will I get an error?

The feature card in the active CMC will be active and installed in the chassis. The second card will be ignored by CMC.

- 6 Does the SD card have a write protection lock on it?

Yes it does. Before installation of the SD card into the CMC module, verify the write protection latch is in the "unlock" position. The FlexAddress feature cannot be activated if the SD card is write protected. In this situation, the `$racadm feature -s` command will return this message:

```
No features active on the chassis. ERROR: read
only file system
```

- 7 What will happen if there isn't an SD card in the active CMC module?

The `$racadm featurecard -s` command will return this message:

```
No feature card inserted.
```

- 8 What will happen if the server BIOS is updated from version 1.xx to version 2.xx?

The server module will need to be powered down. After the server BIOS update is complete, the server modules do not get chassis-assigned addresses.

- 9 What will happen if a chassis with a single CMC is downgraded with firmware prior to 1.10?

The FlexAddress feature and configuration will be removed. Once the CMC firmware is upgraded to 1.10 or later, the FlexAddress feature will need to be reactivated and configured by the user.

- 10 In a chassis with redundant CMCs, if you are replacing a CMC unit with one that has firmware prior to 1.10, the following procedure must be used to ensure the current FlexAddress feature and configuration will NOT be removed.
- a Ensure the active CMC firmware is always version 1.10 or later.
  - b Remove the standby CMC and insert the new CMC in its place.
  - c From the Active CMC, upgrade the standby CMC firmware to 1.10 later.



**NOTE:** If a user does not update the standby CMC firmware to 1.10 or later and a failover occurs, the FlexAddress feature will not be configured and the user will need to reactivate the feature.

- 11 I have the SD card properly installed and all the firmware/software updates installed. I see that FlexAddress is active, but I can't see anything on the server deployment screen to deploy it? What is wrong?

This is a browser caching issue; shut down the browser and relaunch.

- 12 Command messages - the following table lists the RACADM commands and output for common FlexAddress situations.



**Table 6-2. FlexAddress Commands and Output**

<b>Situation</b>	<b>Command</b>	<b>Output</b>
SD card in the active CMC module is bound to another service tag.	<code>\$racadm featurecard -s</code>	The feature card inserted is valid and contains the following feature(s)  FlexAddress: The feature card is bound to another chassis, svctag = J310TF1 SD card SN =0188BFFE03A
SD card in the active CMC module that is bound to the same service tag.	<code>\$racadm featurecard -s</code>	The feature card inserted is valid and contains the following feature(s)  FlexAddress: The feature card is bound to this chassis
SD card in the active CMC module that is not bound to any service tag.	<code>\$racadm featurecard -s</code>	The feature card inserted is valid and contains the following feature(s)  FlexAddress: The feature card is not bound to any chassis

**Table 6-2. FlexAddress Commands and Output (continued)**

<b>Situation</b>	<b>Command</b>	<b>Output</b>
FlexAddress feature not active on the chassis for any reason (No SD card inserted/ corrupt SD card/ after feature deactivated/SD card bound to a different chassis)	<code>\$racadm getflexaddr [-i &lt;slot#&gt;] OR</code> <code>\$racadm setflexaddr [-f &lt;fabricName&gt; &lt;slotState&gt;] OR</code> <code>\$racadm setflexaddr [-i &lt;slot#&gt; &lt;slotState&gt;]</code>	ERROR: Flexaddress feature is not active on the chassis
Guest user attempts to set FlexAddress on slots/fabrics	<code>\$racadm setflexaddr [-f &lt;fabricName&gt; &lt;slotState&gt;]</code> <code>\$racadm setflexaddr [-i &lt;slot#&gt; &lt;slotState&gt;]</code>	ERROR: Insufficient user privileges to perform operation
Deactivating FlexAddress feature with chassis powered ON	<code>\$racadm feature -d -c flexaddress</code>	ERROR: Unable to deactivate the feature because the chassis is powered ON
Guest user tries to deactivate the feature on the chassis	<code>\$racadm feature -d -c flexaddress</code>	ERROR: Insufficient user privileges to perform operation
Changing the slot/fabric FlexAddress settings while the server modules are powered ON	<code>\$racadm setflexaddr -i 1 1</code>	ERROR: Unable to perform the set operation because it effects a powered ON server

# **FlexAddress DELL SOFTWARE LICENSE AGREEMENT**

This is a legal agreement between you, the user, and Dell Products L.P or Dell Global B.V. ("Dell"). This agreement covers all software that is distributed with the Dell product, for which there is no separate license agreement between you and the manufacturer or owner of the software (collectively the "Software"). This agreement is not for the sale of Software or any other intellectual property. All title and intellectual property rights in and to Software is owned by the manufacturer or owner of the Software. All rights not expressly granted under this agreement are reserved by the manufacturer or owner of the Software. By opening or breaking the seal on the Software packet(s), installing or downloading the Software, or using the Software that has been preloaded or is embedded in your product, you agree to be bound by the terms of this agreement. If you do not agree to these terms, promptly return all Software items (disks, written materials, and packaging) and delete any preloaded or embedded Software.

You may use one copy of the Software on only one computer at a time. If you have multiple licenses for the Software, you may use as many copies at any time as you have licenses. "Use" means loading the Software in temporary memory or permanent storage on the computer. Installation on a network server solely for distribution to other computers is not "use" if (but only if) you have a separate license for each computer to which the Software is distributed. You must ensure that the number of persons using the Software installed on a network server does not exceed the number of licenses that you have. If the number of users of Software installed on a network server will exceed the number of licenses, you must purchase additional licenses until the number of licenses equals the number of users before allowing additional users to use the Software. If you are a commercial customer of Dell or a Dell affiliate, you hereby grant Dell, or an agent selected by Dell, the right to perform an audit of your use of the Software during normal business hours, you agree to cooperate with Dell in such audit, and you agree to provide Dell with all records reasonably related to your use of the Software. The audit will be limited to verification of your compliance with the terms of this agreement.

The Software is protected by United States copyright laws and international treaties. You may make one copy of the Software solely for backup or archival purposes or transfer it to a single hard disk provided you keep the original solely for backup or archival purposes. You may not rent or lease the Software or copy the written materials accompanying the Software, but you may transfer the Software and all accompanying materials on a permanent basis as part of a sale or transfer of the Dell product if you retain no copies and the recipient agrees to the terms hereof. Any transfer must include the most recent update and all prior versions. You may not reverse engineer, decompile or disassemble the Software. If the package accompanying your computer contains compact discs, 3.5" and/or 5.25" disks, you may use only the disks appropriate for your computer. You may not use the disks on another computer or network, or loan, rent, lease, or transfer them to another user except as permitted by this agreement.

## LIMITED WARRANTY

Dell warrants that the Software disks will be free from defects in materials and workmanship under normal use for ninety (90) days from the date you receive them. This warranty is limited to you and is not transferable. Any implied warranties are limited to ninety (90) days from the date you receive the Software. Some jurisdictions do not allow limits on the duration of an implied warranty, so this limitation may not apply to you. The entire liability of Dell and its suppliers, and your exclusive remedy, shall be (a) return of the price paid for the Software or (b) replacement of any disk not meeting this warranty that is sent with a return authorization number to Dell, at your cost and risk. This limited warranty is void if any disk damage has resulted from accident, abuse, misapplication, or service or modification by someone other than Dell. Any replacement disk is warranted for the remaining original warranty period or thirty (30) days, whichever is longer.

Dell does NOT warrant that the functions of the Software will meet your requirements or that operation of the Software will be uninterrupted or error free. You assume responsibility for selecting the Software to achieve your intended results and for the use and results obtained from the Software.

DELL, ON BEHALF OF ITSELF AND ITS SUPPLIERS, DISCLAIMS ALL OTHER WARRANTIES, EXPRESS OR IMPLIED, INCLUDING, BUT NOT LIMITED TO, IMPLIED WARRANTIES OF MERCHANTABILITY AND FITNESS FOR A PARTICULAR PURPOSE, FOR THE SOFTWARE AND ALL ACCOMPANYING WRITTEN MATERIALS. This limited warranty gives you specific legal rights; you may have others, which vary from jurisdiction to jurisdiction.

IN NO EVENT SHALL DELL OR ITS SUPPLIERS BE LIABLE FOR ANY DAMAGES WHATSOEVER (INCLUDING, WITHOUT LIMITATION, DAMAGES FOR LOSS OF BUSINESS PROFITS, BUSINESS INTERRUPTION, LOSS OF BUSINESS INFORMATION, OR OTHER PECUNIARY LOSS) ARISING OUT OF USE OR INABILITY TO USE THE SOFTWARE, EVEN IF ADVISED OF THE POSSIBILITY OF SUCH DAMAGES. Because some jurisdictions do not allow an exclusion or limitation of liability for consequential or incidental damages, the above limitation may not apply to you.

## OPEN SOURCE SOFTWARE

A portion of this CD may contain open source software, which you can use under the terms and conditions of the specific license under which the open source software is distributed.

THIS OPEN SOURCE SOFTWARE IS DISTRIBUTED IN THE HOPE THAT IT WILL BE USEFUL, BUT IS PROVIDED "AS IS" WITHOUT ANY EXPRESSED OR IMPLIED WARRANTY; INCLUDING BUT NOT LIMITED TO THE IMPLIED WARRANTY OF MERCHANTABILITY OR FITNESS FOR A PARTICULAR PURPOSE. IN NO EVENT SHALL DELL, THE COPYRIGHT HOLDERS, OR THE CONTRIBUTORS BE LIABLE FOR ANY DIRECT, INDIRECT, INCIDENTAL, SPECIAL, EXEMPLARY, OR CONSEQUENTIAL DAMAGES (INCLUDING, BUT NOT LIMITED TO, PROCUREMENT OF SUBSTITUTE GOODS OR SERVICES; LOSS OF USE, DATA, OR PROFITS; OR BUSINESS INTERRUPTION) HOWEVER CAUSED AND ON ANY THEORY OF LIABILITY, WHETHER IN CONTRACT, STRICT LIABILITY, OR TORT

(INCLUDING NEGLIGENCE OR OTHERWISE) ARISING IN ANY WAY OUT OF THE USE OF THIS SOFTWARE, EVEN IF ADVISED OF THE POSSIBILITY OF SUCH DAMAGE.

## .U.S. GOVERNMENT RESTRICTED RIGHTS

The software and documentation are "commercial items" as that term is defined at 48 C.F.R. 2.101, consisting of "commercial computer software" and "commercial computer software documentation" as such terms are used in 48 C.F.R. 12.212. Consistent with 48 C.F.R. 12.212 and 48 C.F.R. 227.7202-1 through 227.7202-4, all U.S. Government end users acquire the software and documentation with only those rights set forth herein.

Contractor/manufacturer is Dell Products, L.P., One Dell Way, Round Rock, Texas 78682.

## GENERAL

This license is effective until terminated. It will terminate upon the conditions set forth above or if you fail to comply with any of its terms. Upon termination, you agree that the Software and accompanying materials, and all copies thereof, will be destroyed. This agreement is governed by the laws of the State of Texas. Each provision of this agreement is severable. If a provision is found to be unenforceable, this finding does not affect the enforceability of the remaining provisions, terms, or conditions of this agreement. This agreement is binding on successors and assigns. Dell agrees and you agree to waive, to the maximum extent permitted by law, any right to a jury trial with respect to the Software or this agreement. Because this waiver may not be effective in some jurisdictions, this waiver may not apply to you. You acknowledge that you have read this agreement, that you understand it, that you agree to be bound by its terms, and that this is the complete and exclusive statement of the agreement between you and Dell regarding the Software.

# Using the CMC With Microsoft Active Directory

A directory service maintains a common database of all information needed for controlling network users, computers, printers, and so on. If your company uses the Microsoft® Active Directory® service software, you can configure the software to provide access to the CMC. This allows you to add and control CMC user privileges to your existing users in your Active Directory software.



**NOTE:** Using Active Directory to recognize CMC users is supported on the Microsoft Windows® 2000 and Windows Server® 2003 operating systems.

## Active Directory Schema Extensions

You can use Active Directory to define user access on CMC through two methods:

- The extended schema solution, which uses Active Directory objects defined by Dell.
- The standard schema solution, which uses Active Directory group objects only.

### Extended Schema Versus Standard Schema

When using Active Directory to configure access to the CMC, you must choose either the extended schema or the standard schema solution.

With the extended schema solution:

- All of the access control objects are maintained in Active Directory.
- Configuring user access on different CMCs with different privilege levels allows maximum flexibility.

With the standard schema solution:

- No schema extension is required, because standard schema use Active Directory objects only.
- Configuration on the Active Directory side is simple.

## Extended Schema Overview

There are two ways to enable Extended Schema Active Directory:

- Using the CMC Web interface. For instructions, see "Configuring the CMC With Extended Schema Active Directory and the Web Interface" on page 183.
- Using the RACADM CLI tool. For instructions, see "Configuring the CMC With Extended Schema Active Directory and RACADM" on page 185.

### Active Directory Schema Extensions

The Active Directory data is a distributed database of Attributes and Classes. The Active Directory schema includes the rules that determine the type of data that can be added or included in the database.

One example of a Class that is stored in the database is the *user class*. User class attributes can include the user's first name, last name, phone number, and so on.

You can extend the Active Directory database by adding your own unique Attributes and Classes to address your company's environment-specific needs. Dell has extended the schema to include the necessary changes to support remote management Authentication and Authorization.

Each Attribute or Class that is added to an existing Active Directory Schema must be defined with a unique ID. To maintain unique IDs across the industry, Microsoft maintains a database of Active Directory Object Identifiers (OIDs). To extend the schema in Microsoft's Active Directory, Dell established unique OIDs, unique name extensions, and uniquely linked attribute IDs for Dell-specific Attributes and Classes:

Dell extension: dell

Dell base OID: 1.2.840.113556.1.8000.1280

RAC LinkID range: 12070–2079

### Overview of the RAC Schema Extensions

Dell provides a group of properties that you can configure. The Dell extended schema include Association, Device, and Privilege properties.



The Association property links together users or groups with a specific set of privileges to one or more RAC devices. This model provides an Administrator maximum flexibility over the different combinations of users, RAC privileges, and RAC devices on the network without adding too much complexity.

## Active Directory Object Overview

When there are two CMCs on the network that you want to integrate with Active Directory for Authentication and Authorization, you must create at least one Association Object and one RAC Device Object for each CMC. You can create multiple Association Objects, and each Association Object can be linked to as many users, groups of users, or RAC Device Objects as required. The users and RAC Device Objects can be members of any domain in the enterprise.

However, each Association Object can be linked (or, may link users, groups of users, or RAC Device Objects) to only one Privilege Object. This example allows an Administrator to control each user's privileges on specific CMCs.

The RAC Device object is the link to the RAC firmware for querying Active Directory for authentication and authorization. When a RAC is added to the network, the Administrator must configure the RAC and its device object with its Active Directory name so users can perform authentication and authorization with Active Directory. Additionally, the Administrator must add the RAC to at least one Association Object in order for users to authenticate.

Figure 7-1 illustrates that the Association Object provides the connection that is needed for all of the Authentication and Authorization.



**NOTE:** The RAC privilege object applies to DRAC 4, DRAC 5, and the CMC.

You can create as many or as few Association Objects as required. However, you must create at least one Association Object, and you must have one RAC Device Object for each RAC (CMC) on the network that you want to integrate with Active Directory.

**Figure 7-1. Typical Setup for Active Directory Objects**

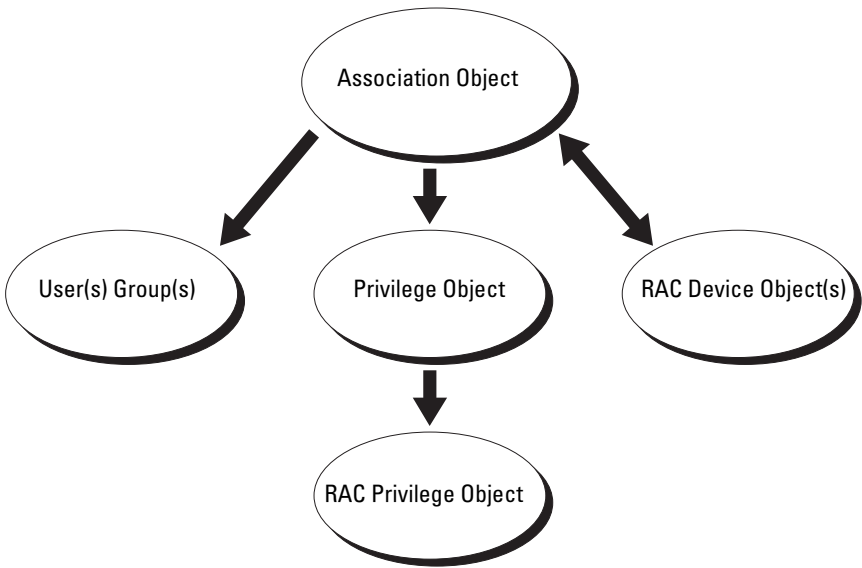

The Association Object allows for as many or as few users and/or groups as well as RAC Device Objects. However, the Association Object only includes one Privilege Object per Association Object. The Association Object connects the "Users" who have "Privileges" on the RACs (CMCs).

Additionally, you can configure Active Directory objects in a single domain or in multiple domains. For example, you have two CMCs (RAC1 and RAC2) and three existing Active Directory users (user1, user2, and user3). You want to give user1 and user2 an administrator privilege to both CMCs and give user3 a login privilege to the RAC2 card. Figure 7-2 illustrates how you set up the Active Directory objects in this scenario.

When adding Universal Groups from separate domains, create an Association Object with Universal Scope. The Default Association objects created by the Dell Schema Extender Utility are Domain Local Groups and will not work with Universal Groups from other domains.

**Figure 7-2. Setting Up Active Directory Objects in a Single Domain**

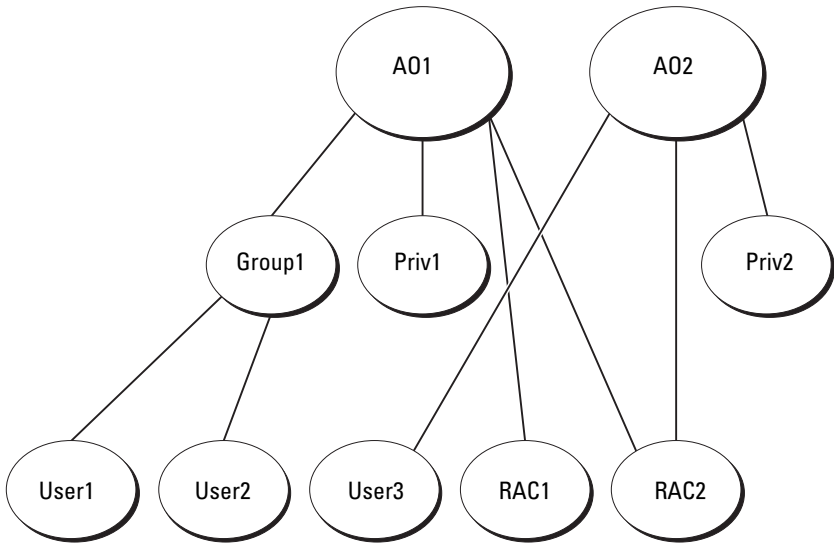

To configure the objects for the single domain scenario:

- 1** Create two Association Objects.
- 2** Create two RAC Device Objects, RAC1 and RAC2, to represent the two CMCs.
- 3** Create two Privilege Objects, Priv1 and Priv2, in which Priv1 has all privileges (administrator) and Priv2 has login privilege.
- 4** Group user1 and user2 into Group1.
- 5** Add Group1 as Members in Association Object 1 (A01), Priv1 as Privilege Objects in A01, and RAC1, RAC2 as RAC Devices in A01.
- 6** Add User3 as Members in Association Object 2 (A02), Priv2 as Privilege Objects in A02, and RAC2 as RAC Devices in A02.

For detailed instruction, see "Adding CMC Users and Privileges to Active Directory" on page 180.

Figure 7-3 provides an example of Active Directory objects in multiple domains. In this scenario, you have two CMCs (RAC1 and RAC2) and three existing Active Directory users (user1, user2, and user3). User1 is in

Domain1, and user2 and user 3 are in Domain2. In this scenario, configure user1 and user 2 with administrator privileges to both CMCs and configure user3 with login privileges to the RAC2 card.

**Figure 7-3. Setting Up Active Directory Objects in Multiple Domains**

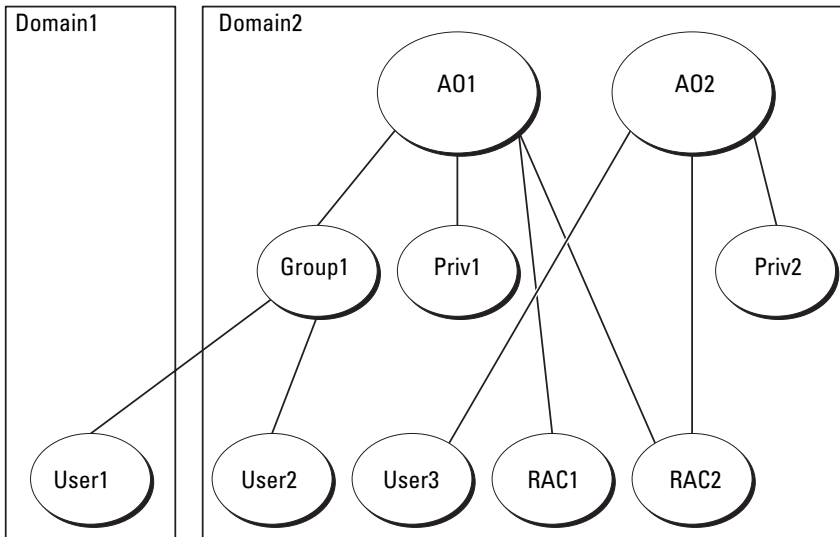

To configure the objects for the multiple domain scenario:

- 1 Ensure that the domain forest function is in Native or Windows 2003 mode.
- 2 Create two Association Objects, A01 (of Universal scope) and A02, in any domain.

Figure 7-3 shows the objects in Domain2.

- 3 Create two RAC Device Objects, RAC1 and RAC2, to represent the two CMCs.
- 4 Create two Privilege Objects, Priv1 and Priv2, in which Priv1 has all privileges (administrator) and Priv2 has login privilege.
- 5 Group user1 and user2 into Group1. The group scope of Group1 must be Universal.

- 6 Add Group1 as Members in Association Object 1 (A01), Priv1 as Privilege Objects in A01, and RAC1, RAC2 as RAC Devices in A01.
- 7 Add User3 as Members in Association Object 2 (A02), Priv2 as Privilege Objects in A02, and RAC2 as RAC Devices in A02.

## **Configuring Extended Schema Active Directory to Access Your CMC**

Before using Active Directory to access your CMC, configure the Active Directory software and the CMC:

- 1 Extend the Active Directory schema (see "Extending the Active Directory Schema" on page 173).
- 2 Extend the Active Directory Users and Computers Snap-In (see "Installing the Dell Extension to the Active Directory Users and Computers Snap-In" on page 179).
- 3 Add CMC users and their privileges to Active Directory (see "Adding CMC Users and Privileges to Active Directory" on page 180).
- 4 Enable SSL on each of your domain controllers.
- 5 Configure the CMC Active Directory properties using either the CMC Web interface or the RACADM (see "Configuring the CMC With Extended Schema Active Directory and the Web Interface" on page 183 or "Configuring the CMC With Extended Schema Active Directory and RACADM" on page 185).

## **Extending the Active Directory Schema**

Extending your Active Directory schema adds a Dell organizational unit, schema classes and attributes, and example privileges and association objects to the Active Directory schema. Before you extend the schema, ensure that you have Schema Admin privilege on the Schema Master Flexible Single Master Operation (FSMO) Role Owner of the domain forest.

You can extend your schema using one of the following methods:

- Dell Schema Extender utility
- LDIF script file

If you use the LDIF script file, the Dell organizational unit will not be added to the schema.

The LDIF files and Dell Schema Extender are located on your *Dell Systems Management Consoles* CD in the following respective directories:

- **Dell**:\support\OMActiveDirectory Tools\RAC4-5\LDIF\_Files
- **Dell**:\support\OMActiveDirectory Tools\RAC4-5\Schema\_Extender

To use the LDIF files, see the instructions in the readme included in the **LDIF\_Files** directory. For instructions on using the Dell Schema Extender to extend the Active Directory Schema, see "Using the Dell Schema Extender."

You can copy and run the Schema Extender or LDIF files from any location.

### Using the Dell Schema Extender



**NOTICE:** The Dell Schema Extender uses the **SchemaExtenderOem.ini** file. To ensure that the Dell Schema Extender utility functions properly, do not modify the name of this file.

- 1 In the **Welcome** screen, click **Next**.
- 2 Read and understand the warning and click **Next**.
- 3 Select **Use Current Log In Credentials** or enter a user name and password with schema administrator rights.
- 4 Click **Next** to run the Dell Schema Extender.
- 5 Click **Finish**.

The schema is extended. To verify the schema extension, use the Microsoft Management Console (MMC) and the Active Directory Schema Snap-In to verify that the following exist:

- Classes — see Table 7-1 through Table 7-6
- Attributes — see Table 7-7

See your Microsoft documentation for more information on how to enable and use the Active Directory Schema Snap-In the MMC.

**Table 7-1. Class Definitions for Classes Added to the Active Directory Schema**

<b>Class Name</b>	<b>Assigned Object Identification Number (OID)</b>
dellRacDevice	1.2.840.113556.1.8000.1280.1.1.1.1
dellAssociationObject	1.2.840.113556.1.8000.1280.1.1.1.2

**Table 7-1. Class Definitions for Classes Added to the Active Directory Schema (continued)**

<b>Class Name</b>	<b>Assigned Object Identification Number (OID)</b>
dellRACPrivileges	1.2.840.113556.1.8000.1280.1.1.1.3
dellPrivileges	1.2.840.113556.1.8000.1280.1.1.1.4
dellProduct	1.2.840.113556.1.8000.1280.1.1.1.5

**Table 7-2. dellRacDevice Class**

OID	1.2.840.113556.1.8000.1280.1.1.1.1
Description	Represents the Dell RAC device. The RAC device must be configured as dellRacDevice in Active Directory. This configuration enables the CMC to send Lightweight Directory Access Protocol (LDAP) queries to Active Directory.
Class Type	Structural Class
SuperClasses	dellProduct
Attributes	dellSchemaVersion dellRacType

**Table 7-3. dellAssociationObject Class**

OID	1.2.840.113556.1.8000.1280.1.1.1.2
Description	Represents the Dell Association Object. The Association Object provides the connection between the users and the devices.
Class Type	Structural Class
SuperClasses	Group
Attributes	dellProductMembers dellPrivilegeMember

**Table 7-4. dellRAC4Privileges Class**

OID	1.2.840.113556.1.8000.1280.1.1.1.3
Description	Defines Authorization Rights (privileges) for the CMC device.
Class Type	Auxiliary Class
SuperClasses	None
Attributes	dellIsLoginUser dellIsCardConfigAdmin dellIsUserConfigAdmin dellIsLogClearAdmin dellIsServerResetUser dellIsTestAlertUser dellIsDebugCommandAdmin dellPermissionMask1 dellPermissionMask2

**Table 7-5. dellPrivileges Class**

OID	1.2.840.113556.1.8000.1280.1.1.1.4
Description	Container Class for the Dell Privileges (Authorization Rights).
Class Type	Structural Class
SuperClasses	User
Attributes	dellRAC4Privileges

**Table 7-6. dellProduct Class**

OID	1.2.840.113556.1.8000.1280.1.1.1.5
Description	The main class from which all Dell products are derived.
Class Type	Structural Class
SuperClasses	Computer
Attributes	dellAssociationMembers



**Table 7-7. List of Attributes Added to the Active Directory Schema**

<b>Assigned OID/Syntax Object Identifier</b>	<b>Single Valued</b>
<b>Attribute: dellPrivilegeMember</b>	
<b>Description:</b> List of dellPrivilege objects that belong to this attribute.	
<b>OID:</b> 1.2.840.113556.1.8000.1280.1.1.2.1	FALSE
<b>Distinguished Name:</b> (LDAPTYPE_DN 1.3.6.1.4.1.1466.115.121.1.12)	
<b>Attribute: dellProductMembers</b>	
<b>Description:</b> List of dellRacDevices objects that belong to this role. This attribute is the forward link to the dellAssociationMembers backward link.	
<b>Link ID:</b> 12070	
<b>OID:</b> 1.2.840.113556.1.8000.1280.1.1.2.2	FALSE
<b>Distinguished Name:</b> (LDAPTYPE_DN 1.3.6.1.4.1.1466.115.121.1.12)	
<b>Attribute: dellIsCardConfigAdmin</b>	
<b>Description:</b> TRUE if the user has Card Configuration rights on the device.	
<b>OID:</b> 1.2.840.113556.1.8000.1280.1.1.2.4	TRUE
Boolean (LDAPTYPE_BOOLEAN 1.3.6.1.4.1.1466.115.121.1.7)	
<b>Attribute: dellIsLoginUser</b>	
<b>Description:</b> TRUE if the user has Login rights on the device.	
<b>OID:</b> 1.2.840.113556.1.8000.1280.1.1.2.3	TRUE
Boolean (LDAPTYPE_BOOLEAN 1.3.6.1.4.1.1466.115.121.1.7)	
<b>Attribute: dellIsCardConfigAdmin</b>	
<b>Description:</b> TRUE if the user has Card Configuration rights on the device.	
<b>OID:</b> 1.2.840.113556.1.8000.1280.1.1.2.4	TRUE
Boolean (LDAPTYPE_BOOLEAN 1.3.6.1.4.1.1466.115.121.1.7)	

**Table 7-7. List of Attributes Added to the Active Directory Schema (continued)**

<b>Assigned OID/Syntax Object Identifier</b>	<b>Single Valued</b>
<b>Attribute: dellIsUserConfigAdmin</b>	
<b>Description:</b> TRUE if the user has User Configuration Administrator rights on the device.	
<b>OID:</b> 1.2.840.113556.1.8000.1280.1.1.2.5	TRUE
Boolean (LDAPTYPE_BOOLEAN 1.3.6.1.4.1.1466.115.121.1.7)	
<b>Attribute: dellIsLogClearAdmin</b>	
<b>Description:</b> TRUE if the user has Clear Logs Administrator rights on the device.	
<b>OID:</b> 1.2.840.113556.1.8000.1280.1.1.2.6	TRUE
Boolean (LDAPTYPE_BOOLEAN 1.3.6.1.4.1.1466.115.121.1.7)	
<b>Attribute: dellIsServerResetUser</b>	
<b>Description:</b> TRUE if the user has Server Reset rights on the device.	
<b>OID:</b> 1.2.840.113556.1.8000.1280.1.1.2.7	TRUE
Boolean (LDAPTYPE_BOOLEAN 1.3.6.1.4.1.1466.115.121.1.7)	
<b>Attribute: dellIsTestAlertUser</b>	
<b>Description:</b> TRUE if the user has Test Alert User rights on the device.	
<b>OID:</b> 1.2.840.113556.1.8000.1280.1.1.2.10	TRUE
Boolean (LDAPTYPE_BOOLEAN 1.3.6.1.4.1.1466.115.121.1.7)	
<b>Attribute: dellIsDebugCommandAdmin</b>	
<b>Description:</b> TRUE if the user has Debug Command Admin rights on the device.	
<b>OID:</b> 1.2.840.113556.1.8000.1280.1.1.2.11	TRUE
Boolean (LDAPTYPE_BOOLEAN 1.3.6.1.4.1.1466.115.121.1.7)	
<b>Attribute: dellSchemaVersion</b>	
<b>Description:</b> The Current Schema Version is used to update the schema.	
<b>OID:</b> 1.2.840.113556.1.8000.1280.1.1.2.12	TRUE
Case Ignore String(LDAPTYPE_CASEIGNORESTRING 1.2.840.113556.1.4.905)	

**Table 7-7. List of Attributes Added to the Active Directory Schema (continued)**

<b>Assigned OID/Syntax Object Identifier</b>	<b>Single Valued</b>
<b>Attribute: dellRacType</b>	
<b>Description:</b> This attribute is the Current Rac Type for the dellRacDevice object and the backward link to the dellAssociationObjectMembers forward link.	
<b>OID:</b> 1.2.840.113556.1.8000.1280.1.1.2.13	TRUE
Case Ignore String(LDAPTYPE_CASEIGNORESTRING 1.2.840.113556.1.4.905)	
<b>Attribute: dellAssociationMembers</b>	
<b>Description:</b> List of dellAssociationObjectMembers that belong to this Product. This attribute is the backward link to the dellProductMembers Linked attribute.	
Link ID: 12071	
<b>OID:</b> 1.2.840.113556.1.8000.1280.1.1.2.14	FALSE
Distinguished Name (LDAPTYPE_DN 1.3.6.1.4.1.1466.115.121.1.12)	
<b>Attribute: dellPermissionsMask1</b>	
<b>OID:</b> 1.2.840.113556.1.8000.1280.1.6.2.1 Integer (LDAPTYPE_INTEGER)	
<b>Attribute: dellPermissionsMask2</b>	
<b>OID:</b> 1.2.840.113556.1.8000.1280.1.6.2.2 Integer (LDAPTYPE_INTEGER)	

## **Installing the Dell Extension to the Active Directory Users and Computers Snap-In**

When you extend the schema in Active Directory, you must also extend the Active Directory Users and Computers Snap-In so the administrator can manage RAC (CMC) devices, Users and User Groups, RAC Associations, and RAC Privileges.

When you install your systems management software using the *Dell Systems Management Consoles* CD, you can extend the Snap-In by selecting the **Dell Extension to the Active Directory User's and Computers Snap-In** option during the installation procedure. See the *Dell OpenManage Software Quick Installation Guide* for additional instructions about installing systems management software.

For more information about the Active Directory User's and Computers Snap-In, see your Microsoft documentation.

### **Installing the Administrator Pack**

You must install the Administrator Pack on each system that is managing the Active Directory CMC Objects. If you do not install the Administrator Pack, you cannot view the Dell RAC Object in the container.

### **Opening the Active Directory Users and Computers Snap-In**

To open the Active Directory Users and Computers Snap-In:

- 1** If you are logged into the domain controller, click **Start Admin Tools**→ **Active Directory Users and Computers**.

If you are not logged into the domain controller, you must have the appropriate Microsoft Administrator Pack installed on your local system. To install this Administrator Pack, click **Start**→ **Run**, type **MMC**, and press **<Enter>**.

The Microsoft Management Console (MMC) appears.

- 2** In the **Console 1** window, click **File** (or **Console** on systems running Windows 2000).
- 3** Click **Add/Remove Snap-in**.
- 4** Select the **Active Directory Users and Computers Snap-In** and click **Add**.
- 5** Click **Close** and click **OK**.

### **Adding CMC Users and Privileges to Active Directory**

Using the Dell-extended Active Directory Users and Computers Snap-In, you can add CMC users and privileges by creating RAC, Association, and Privilege objects. To add each object type, you will:

- 1** Create a RAC device Object.
- 2** Create a Privilege Object.
- 3** Create an Association Object.
- 4** Add objects to an Association Object.

### Creating a RAC Device Object

- 1 In the MMC Console Root window, right-click a container.
- 2 Select **New→ Dell RAC Object**.  
The **New Object** window appears.
- 3 Type a name for the new object. The name must be identical to the CMC Name that you will type in step 8a of "Configuring the CMC With Extended Schema Active Directory and the Web Interface" on page 183.
- 4 Select **RAC Device Object**.
- 5 Click **OK**.

### Creating a Privilege Object



**NOTE:** A Privilege Object must be created in the same domain as the related Association Object.

- 1 In the **Console Root** (MMC) window, right-click a container.
- 2 Select **New→ Dell RAC Object**.  
The **New Object** window appears.
- 3 Type a name for the new object.
- 4 Select **Privilege Object**.
- 5 Click **OK**.
- 6 Right-click the privilege object that you created, and select **Properties**.
- 7 Click the **RAC Privileges** tab and select the privileges that you want the user to have. For more information about CMC user privileges, see "User Types" on page 108.

### Creating an Association Object

The Association Object is derived from a Group and must contain a Group Type. The Association Scope specifies the Security Group Type for the Association Object. When you create an Association Object, choose the Association Scope that applies to the type of objects you intend to add.

For example, if you select **Universal**, the association objects are only available when the Active Directory Domain is functioning in Native Mode or above.

- 1 In the **Console Root** (MMC) window, right-click a container.
- 2 Select **New**→ **Dell RAC Object**.  
This opens the **New Object** window.
- 3 Type a name for the new object.
- 4 Select **Association Object**.
- 5 Select the scope for the **Association Object**.
- 6 Click **OK**.

### **Adding Objects to an Association Object**

Using the **Association Object Properties** window, you can associate users or user groups, privilege objects, and RAC devices or RAC device groups. If your system is running Windows 2000 mode or higher, use Universal Groups to span domains with your user or RAC objects.

You can add groups of Users and RAC devices. The procedure for creating Dell-related groups and non-Dell-related groups is identical.

### **Adding Users or User Groups**

- 1 Right-click the **Association Object** and select **Properties**.
- 2 Select the **Users** tab and click **Add**.
- 3 Type the user or User Group name and click **OK**.

Click the **Privilege Object** tab to add the privilege object to the association that defines the user's or user group's privileges when authenticating to a RAC device. Only one privilege object can be added to an Association Object.

### **Adding Privileges**

- 1 Select the **Privileges Object** tab and click **Add**.
- 2 Type the Privilege Object name and click **OK**.

Click the **Products** tab to add one or more RAC devices to the association. The associated devices specify the RAC devices connected to the network that are available for the defined users or user groups. Multiple RAC devices can be added to an Association Object.

## Adding RAC Devices or RAC Device Groups

To add RAC devices or RAC device groups:

- 1 Select the **Products** tab and click **Add**.
- 2 Type the RAC device or RAC device group name and click **OK**.
- 3 In the **Properties** window, click **Apply** and click **OK**.

## Configuring the CMC With Extended Schema Active Directory and the Web Interface

- 1 Log in to the CMC Web interface.
- 2 Select **Chassis** in the system tree.
- 3 Click the **Network/Security** tab, and then click the **Active Directory** sub-tab. The **Active Directory Main Menu** page appears.
- 4 Select the **Configure** radio button, and then click **Next**. The **Active Directory Configuration and Management** page appears.
- 5 In the **Common Settings** section:
  - a Select the **Enable Active Directory** check box so that it is checked.
  - b Type the **Root Domain Name**. The **Root Domain Name** is the fully qualified root domain name for the forest.



**NOTE:** The **Root domain name** must be a valid domain name using the *x.y* naming convention, where *x* is a 1–256 character ASCII string with no spaces between characters, and *y* is a valid domain type such as *com*, *edu*, *gov*, *int*, *mil*, *net*, or *org*.

- c Type the **Timeout** time in seconds. **Configuration range:** 15–300 seconds. **Default:** 90 seconds
- 6 **Optional:** If you want the directed call to search the domain controller and global catalog, select the **Search AD Server to search (Optional)** check box, then:
    - a In the **Domain Controller** text field, type the server where your Active Directory service is installed.
    - b In the **Global Catalog** text field, type the location of the global catalog on the Active Directory domain controller. The global catalog provides a resource for searching an Active Directory forest.

- 7 Select the **Use Extended Schema** radio button in the **Active Directory Schema Selection** area.
- 8 In the **Extended Schema Settings** section:
  - a Type the **CMC Name**. The **CMC Name** uniquely identifies the CMC card in Active Directory. The **CMC Name** must be the same as the common name of the new CMC object you created in your Domain Controller. The **CMC Name** must be a 1–256 character ASCII string with no spaces between characters.
  - b Type the **CMC Domain Name** (example: `cmc.com`). The **CMC Domain Name** is the DNS name (string) of the domain where the Active Directory CMC object resides. The name must be a valid domain name consisting of `x.y`, where `x` is a 1–256 character ASCII string with no spaces between characters, and `y` is a valid domain type such as `com`, `edu`, `gov`, `int`, `mil`, `net`, or `org`.
- 9 Click **Apply** to save your settings.



**NOTE:** You must apply your settings before continuing to the next step, in which you navigate to another page. If you do not apply the settings, you will lose the settings you entered when you navigate to the next page.

- 10 Click **Go Back To Active Directory Main Menu**.
- 11 Select the **Upload AD Certificate** radio button, and then click **Next**. The **Certificate Upload** page appears.
- 12 Type the file path of the certificate in the text field, or click **Browse** to select the certificate file.



**NOTE:** The **File Path** value displays the relative file path of the certificate you are uploading. You must type the absolute file path, which includes the full path and the complete file name and file extension.

The SSL certificates for the domain controller must be signed by the root certificate authority. The root certificate authority-signed certificate must be available on the management station accessing the CMC.

- 13 Click **Apply**. The CMC Web server automatically restarts after you click **Apply**.
- 14 Log back in to the CMC Web interface.
- 15 Select **Chassis** in the system tree, click the **Network/Security** tab, then click the **Network** sub-tab. The **Network Configuration** page appears.



**16** If **Use DHCP (for NIC IP Address)** is enabled (checked), do one of the following:

- Select **Use DHCP to Obtain DNS Server Addresses** to enable the DNS server addresses to be obtained automatically by the DHCP server., or
- Manually configure a DNS server IP address by leaving the **Use DHCP to Obtain DNS Server Addresses** check box unchecked and then typing your primary and alternate DNS server IP addresses in the fields provided.

**17** Click **Apply Changes**.

The CMC Extended Schema Active Directory feature configuration is complete.

## **Configuring the CMC With Extended Schema Active Directory and RACADM**

Using the following commands to configure the CMC Active Directory Feature with Extended Schema using the RACADM CLI tool instead of the Web interface.

**1** Open a Telnet/SSH text console to the CMC, log in, and type:

```
racadm config -g cfgActiveDirectory -o cfgADEnable
1

racadm config -g cfgActiveDirectory -o cfgADType 1

racadm config -g cfgActiveDirectory -o
cfgADRacDomain <fully qualified CMC domain name>

racadm config -g cfgActiveDirectory -o
cfgADRootDomain <fully qualified root domain name>

racadm config -g cfgActiveDirectory -o
cfgADRacName <CMC common name>

racadm sslcertupload -t 0x2 -f <ADS root CA
certificate> -r

racadm sslcertdownload -t 0x1 -f <CMC SSL
certificate>
```

**Optional:** If you want to specify an LDAP or Global Catalog server instead of using the servers returned by the DNS server to search for a user name, type the following command to enable the **Specify Server** option:

```
racadm config -g cfgActiveDirectory -o  
cfgADSpecifyServerEnable 1
```

 **NOTE:** When you use the **Specify Server** option, the host name in the certificate authority-signed certificate is not matched against the name of the specified server. This is particularly useful if you are a CMC administrator, because it enables you to enter a host name as well as an IP address.

After you enable the **Specify Server** option, you can specify an LDAP server and global catalog with IP addresses or fully qualified domain names (FQDNs) of the servers. The FQDNs consist of the host names and the domain names of the servers.

To specify an LDAP server, type:

```
racadm config -g cfgActiveDirectory -o  
cfgADDomainController <AD domain controller IP  
address>
```

To specify a Global Catalog server, type:

```
racadm config -g cfgActiveDirectory -o  
cfgADGlobalCatalog <AD global catalog IP address>
```

 **NOTE:** Setting the IP address as 0.0.0.0 disables the CMC from searching for a server.

 **NOTE:** You can specify a list of LDAP or global catalog servers separated by commas. The CMC allows you to specify up to three IP addresses or host names.

 **NOTE:** LDAP or LDAPs that are not correctly configured for all domains and applications may produce unexpected results during the functioning of the existing applications/domains.

- 2 Specify a DNS server using one of the following options:
  - If DHCP is enabled on the CMC and you want to use the DNS address obtained automatically by the DHCP server, type the following command:

```
racadm config -g cfgLanNetworking -o  
cfgDNSServersFromDHCP 1
```

- If DHCP is disabled on the CMC, or if DHCP is enabled but you want to specify your DNS IP address manually, type following commands:

```
racadm config -g cfgLanNetworking -o  
cfgDNSServersFromDHCP 0
```

```
racadm config -g cfgLanNetworking -o  
cfgDNSServer1 <primary DNS IP address>
```

```
racadm config -g cfgLanNetworking -o  
cfgDNSServer2 <secondary DNS IP address>
```

The Extended Schema feature configuration is complete.

## Standard Schema Active Directory Overview

Using standard schema for Active Directory integration requires configuration on both Active Directory and the CMC.

On the Active Directory side, a standard group object is used as a role group. A user who has CMC access will be a member of the role group.

In order to give this user access to a specific CMC card, the role group name and its domain name need to be configured on the specific CMC card. Unlike the extended schema solution, the role and the privilege level is defined on each CMC card, not in the Active Directory. Up to five role groups can be configured and defined in each CMC. Table 5-10 shows the privileges level of the role groups and Table 7-8 shows the default role group settings.

**Figure 7-4. Configuration of CMC with Active Directory and Standard Schema**

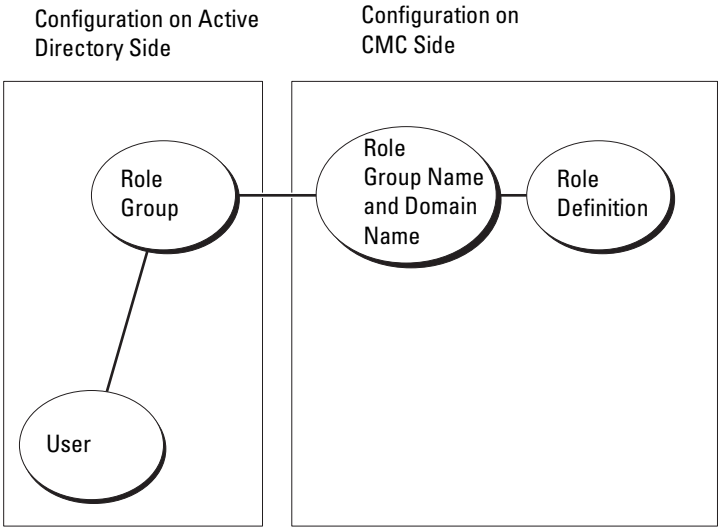

**Table 7-8. Default Role Group Privileges**

<b>Role Group</b>	<b>Default Privilege Level</b>	<b>Permissions Granted</b>	<b>Bit Mask</b>
1	None	<ul style="list-style-type: none"><li>• CMC Login User</li><li>• Chassis Configuration Administrator</li><li>• User Configuration Administrator</li><li>• Clear Logs Administrator</li><li>• Chassis Control Administrator (Power Commands)</li><li>• Super User</li><li>• Server Administrator</li><li>• Test Alert User</li><li>• Debug Command User</li><li>• Fabric A Administrator</li><li>• Fabric B Administrator</li><li>• Fabric C Administrator</li></ul>	0x00000fff
2	None	<ul style="list-style-type: none"><li>• CMC Login User</li><li>• Clear Logs Administrator</li><li>• Chassis Control Administrator (Power Commands)</li><li>• Server Administrator</li><li>• Test Alert User</li><li>• Fabric A Administrator</li><li>• Fabric B Administrator</li><li>• Fabric C Administrator</li></ul>	0x000000f9
3	None	CMC Login User	0x00000001
4	None	No assigned permissions	0x00000000
5	None	No assigned permissions	0x00000000

 **NOTE:** The bit mask values are used only when setting Standard Schema with the RACADM.

 **NOTE:** For more information about user privileges, see "User Types" on page 107.

There are two ways to enable Standard Schema Active Directory:

- With the CMC Web interface. See "Configuring the CMC With Standard Schema Active Directory and Web Interface" on page 190.
- With the RACADM CLI tool. See "Configuring the CMC With Standard Schema Active Directory and RACADM" on page 193.

### **Configuring Standard Schema Active Directory to Access Your CMC**

You need to perform the following steps to configure the Active Directory before an Active Directory user can access the CMC:

- 1 On an Active Directory server (domain controller), open the Active Directory Users and Computers Snap-in.
- 2 Create a group or select an existing group. The name of the group and the name of this domain will need to be configured on the CMC either with the Web interface or RACADM.

For more information, see "Configuring the CMC With Standard Schema Active Directory and Web Interface" on page 190 or "Configuring the CMC With Standard Schema Active Directory and RACADM" on page 193.

- 3 Add the Active Directory user as a member of the Active Directory group to access the CMC.

### **Configuring the CMC With Standard Schema Active Directory and Web Interface**

- 1 Log in to the CMC Web interface.
- 2 Select **Chassis** in the system tree.
- 3 Click the **Network/Security** tab, and then click the **Active Directory** sub-tab. The **Active Directory Main Menu** page appears.
- 4 Select the **Configure** option, and then click **Next**. The **Active Directory Configuration and Management** page appears.

5 In the **Common Settings** section:

- a Select the **Enable Active Directory** check box.
- b Type the **ROOT Domain Name**. The **ROOT Domain Name** is the fully qualified root domain name for the forest.



**NOTE:** The **ROOT domain name** must be a valid domain name using the *x.y* naming convention, where *x* is a 1–256 character ASCII string with no spaces between characters, and *y* is a valid domain type such as com, edu, gov, int, mil, net, or org.

- c Type the **Timeout** time in seconds. **Configuration range:** 15–300 seconds. **Default:** 90 seconds

6 **Optional:** If you want the directed call to search the domain controller and global catalog, select the **Search AD Server to search (Optional)** check box, then:

- a In the **Domain Controller** text field, type the server where your Active Directory service is installed.
- b In the **Global Catalog** text field, type the location of the global catalog on the Active Directory domain controller. The global catalog provides a resource for searching an Active Directory forest.

7 Click **Use Standard Schema** in the Active Directory Schema Selection section.

8 Click **Apply** to save your settings.



**NOTE:** You must apply your settings before continuing to the next step, in which you navigate to another page. If you do not apply the settings, you will lose the settings you entered when you navigate to the next page.

9 In the **Standard Schema Settings** section, click a **Role Group**. The **Configure Role Group** page appears.

10 Type the **Group Name**. The group name identifies the role group in the Active Directory associated with the CMC card.

11 Type the **Group Domain**. The **Group Domain** is the fully qualified root domain name for the forest.

12 In the **Role Group Privileges** page, select privileges for the group.

If you modify any of the privileges, the existing **Role Group Privilege** (Administrator, Power User, or Guest User) will change to either the Custom group or the appropriate Role Group Privilege. See Table 5-10.

- 13** Click **Apply** to save the Role Group settings.
- 14** Click **Go Back To Active Directory Configuration and Management**.
- 15** Click **Go Back To Active Directory Main Menu**.
- 16** Upload your domain forest Root certificate authority-signed certificate into the CMC.
  - a** Select the **Upload Active Directory CA Certificate** check box and then click **Next**.
  - b** In the **Certificate Upload** page, type the file path of the certificate or browse to the certificate file.



**NOTE:** The **File Path** value displays the relative file path of the certificate you are uploading. You must type the absolute file path, which includes the full path and the complete file name and file extension.

The SSL certificates for the domain controllers must be signed by the root certificate authority-signed certificate. The root certificate authority-signed certificate must be available on the management station accessing the CMC.

- c** Click **Apply**. The CMC Web server automatically restarts after you click **Apply**.
- 17** Log out and then log in to the CMC to complete the CMC Active Directory feature configuration.
- 18** Select **Chassis** in the system tree.
- 19** Click the **Network/Security** tab.
- 20** Click the **Network** sub-tab. The **Network Configuration** page appears.
- 21** If **Use DHCP (for NIC IP Address)** is selected under **Network Settings**, select **Use DHCP to obtain DNS server address**.

To manually input a DNS server IP address, deselect **Use DHCP to obtain DNS server addresses** and type your primary and alternate DNS server IP addresses.

- 22** Click **Apply Changes**.

The CMC Standard Schema Active Directory feature configuration is complete.



## Configuring the CMC With Standard Schema Active Directory and RACADM

To configure the CMC Active Directory Feature with Standard Schema using the RACADM CLI, use the following commands:

- 1 Open a Telnet/SSH text console to the CMC, log in, and type:

```
racadm config -g cfgActiveDirectory -o cfgADEnable 1
```

```
racadm config -g cfgActiveDirectory -o cfgADType 2
```

```
racadm config -g cfgActiveDirectory -o  
cfgADRootDomain <fully qualified root domain name>
```

```
racadm config -g cfgStandardSchema -i <index> -o  
cfgSSADRoleGroupName <common name of the role  
group>
```

```
racadm config -g cfgStandardSchema -i <index> -o  
cfgSSADRoleGroupDomain <fully qualified domain  
name>
```

```
racadm config -g cfgStandardSchema -i <index> -o  
cfgSSADRoleGroupPrivilege <Bit mask number for  
specific user permissions>
```

```
racadm sslcertupload -t 0x2 -f <ADS root CA  
certificate>
```

```
racadm sslcertdownload -t 0x1 -f <RAC SSL  
certificate>
```

 **NOTE:** For bit mask number values, see "Bit Masks for User Privileges" on page 356.

- 2 Specify a DNS server using one of the following options:
  - If DHCP is enabled on the CMC and you want to use the DNS address obtained automatically by the DHCP server, type the following command:

```
racadm config -g cfgLanNetworking -o  
cfgDNSServersFromDHCP 1
```

- If DHCP is disabled on the CMC or you want manually to input your DNS IP address, type the following commands:

```
racadm config -g cfgLanNetworking -o
cfgDNSServersFromDHCP 0
```

```
racadm config -g cfgLanNetworking -o
cfgDNSServer1 <primary DNS IP address>
```

```
racadm config -g cfgLanNetworking -o
cfgDNSServer2 <secondary DNS IP address>
```

## Frequently Asked Questions

Table 7-9 lists frequently asked questions and answers about using Active Directory with the CMC.

**Table 7-9. Using CMC With Active Directory: Frequently Asked Questions**

Question	Answer
Can I log into the CMC using Active Directory across multiple trees?	Yes. The CMC's Active Directory querying algorithm supports multiple trees in a single forest.
Does the login to the CMC using Active Directory work in mixed mode (that is, the domain controllers in the forest run different operating systems, such as Microsoft Windows <sup>®</sup> 2000 or Windows Server <sup>®</sup> 2003)?	Yes. In mixed mode, all objects used by the CMC querying process (among user, RAC Device Object, and Association Object) must be in the same domain.  The Dell-extended Active Directory Users and Computers Snap-In checks the mode and limits users in order to create objects across domains if in mixed mode.
Does using the CMC with Active Directory support multiple domain environments?	Yes. The domain forest function level must be in Native mode or Windows 2003 mode. In addition, the groups among Association Object, RAC user objects, and RAC Device Objects (including Association Object) must be universal groups.

**Table 7-9. Using CMC With Active Directory: Frequently Asked Questions (continued)**

<b>Question</b>	<b>Answer</b>
Can these Dell-extended objects (Dell Association Object, Dell RAC Device, and Dell Privilege Object) be in different domains?	The Association Object and the Privilege Object must be in the same domain. The Dell-extended Active Directory Users and Computers Snap-In forces you to create these two objects in the same domain. Other objects can be in different domains.
Are there any restrictions on Domain Controller SSL configuration?	Yes. All SSL certificates for Active Directory servers in the forest must be signed by the same root certificate authority-signed certificate, because CMC only allows you to upload one trusted certificate authority-signed SSL certificate.
I created and uploaded a new RAC certificate and now the Web interface does not launch.	If you use Microsoft Certificate Services to generate the RAC certificate, you may have inadvertently chose <b>User Certificate</b> instead of <b>Web Certificate</b> when creating the certificate. To recover, generate a CSR, and then create a new Web certificate from Microsoft Certificate Services and upload it using the using the following RACADM commands: <pre>racadm sslcsrgen [-g] [-u] [-f {filename}] racadm sslcertupload -t 1 -f {web_sslcert}</pre>

**Table 7-9. Using CMC With Active Directory: Frequently Asked Questions (continued)**

Question	Answer
What can I do if I cannot log into the CMC using Active Directory authentication? How do I troubleshoot the issue?	<p><b>1</b> Ensure that you use the correct user domain name during a login and not the NetBIOS name.</p> <p><b>2</b> If you have a local CMC user account, log into the CMC using your local credentials. After you are logged in, perform the following steps:</p> <ul style="list-style-type: none"><li><b>a</b> Ensure that you have checked the <b>Enable Active Directory</b> check box on the CMC Active Directory configuration page.</li><li><b>b</b> Ensure that the DNS setting is correct on the CMC Networking configuration page.</li><li><b>c</b> Ensure that you have uploaded the Active Directory certificate from your Active Directory root certificate authority-signed certificate to the CMC.</li><li><b>d</b> Check the Domain Controller SSL certificates to ensure that they have not expired.</li><li><b>e</b> Ensure that your <b>CMC Name</b>, <b>Root Domain Name</b>, and <b>CMC Domain Name</b> match your Active Directory environment configuration.</li><li><b>f</b> Ensure that the CMC password has a maximum of 127 characters. While the CMC can support passwords of up to 256 characters, Active Directory only supports passwords that have a maximum length of 127 characters.</li></ul>

# Power Management

## Overview

The M1000e chassis ships with either three power supply units (PSUs) or six, the maximum. If your chassis has three PSUs, you can add up to three more.

The PSUs supply power to the chassis and all the modules in the chassis: CMC, IOM, iKVM, fans, front panel LCD and servers. The CMC manages the power budget for all the chassis modules.

For AC redundancy to work in a six-PSU configuration, the three PSUs on the left must connect to one AC power grid while the three on the right connect to another. AC Redundancy is not available in a three-PSU configuration. Each PSU helps the CMC manage the power distribution to the modules.

## Power Budgeting for Hardware Modules

The CMC allocates power to some of the modules in the M1000e chassis statically, and others dynamically. Static allocation means these modules are assumed to be present and they are allocated a fixed amount of power. Dynamic modules are given a power allocation by the CMC as they are installed into the chassis.

The power budget for hardware modules in the chassis, including servers, iDRACs on the servers, and IOMs, is allocated dynamically after enumeration.

The chassis consists of compute and non-compute hardware modules. Compute hardware modules include servers and iDRACs on the servers. Non-compute hardware modules include the active CMC, standby CMC (if present), iKVM, IOMs, front panel LCD, and fans. The power budget for essential non-compute modules in the chassis is pre-allocated, which means that the CMC will not decrease power to these modules to conserve power in the event of a power loss.

**Figure 8-1. Chassis With Six-PSU Configuration**

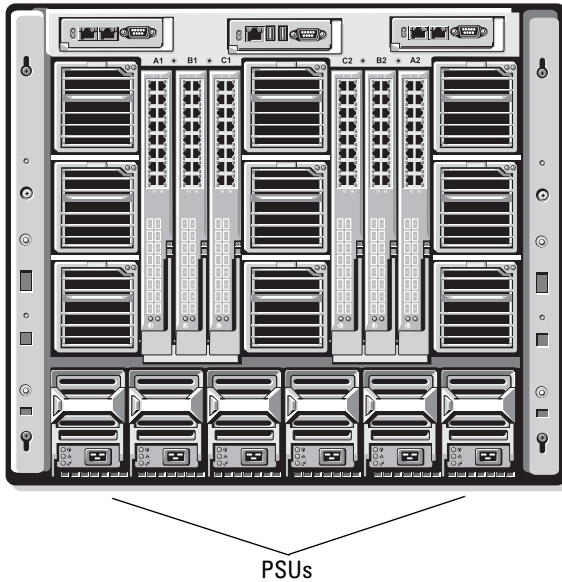

### **Dynamic PSU Engagement**

Dynamic PSU engagement is a configurable option that enables the CMC to conserve power by powering-off unused PSUs and keeping them in standby mode in case more power is required. This saves power by increasing the utilization of the PSUs that remain active so that they are used more efficiently.

When dynamic PSU engagement is enabled, the CMC enumerates all PSUs in the chassis at initial power-up and when a new PSU is added to the chassis. The CMC enumerates power based on how much power is required for a given configuration. Factors that contribute to power enumeration include the following:

- Module population
- Real-time power consumption
- The infrastructure’s static worst-case needs
- The number of PSUs in the chassis

- The redundancy policy
- The capabilities and maximum efficiency point of the PSU configuration

**Table 8-1. Power Allocation in Compute vs. Non-compute Modules**

<b>Modules</b>	<b>Power Budget Allocation</b>	<b>Compute versus Non-compute</b>
Servers	Dynamic	Compute
iDRAC on servers	Dynamic	Compute
IOMs	Dynamic	Non-compute
Primary CMC	Pre-allocated	Non-compute
Standby CMC	Pre-allocated	Non-compute
iKVM	Pre-allocated	Non-compute
Front Panel LCD	Pre-allocated	Non-compute
Fans	Pre-allocated	Non-compute

To maintain optimal efficiency, the CMC uses this information to determine how many PSUs are required to power a given configuration and place excess PSUs on standby. If new modules are installed, the CMC may, depending on need and optimization, turn on new supplies.

## Redundancy Policies

The redundancy policy is a configurable set of properties that determine how the CMC manages power to the chassis. The following redundancy policies are configurable with or without dynamic PSU engagement:

- AC Redundancy
- Power Supply Redundancy
- No Redundancy

You can select and configure a redundancy policy or use the default redundancy policy for your chassis. The default redundancy configuration for your chassis depends on how many PSUs are configured for it, as shown in Table 8-2.

**Table 8-2. Default Redundancy Configuration**

<b>PSU Configuration</b>	<b>Default Redundancy Policy</b>	<b>Default Dynamic PSU Engagement Setting</b>
Six PSUs	AC Redundancy	Disabled
Three PSUs	No Redundancy	Disabled

## **AC Redundancy**

For AC Redundancy mode to operate at optimal power, you must have six PSUs in your chassis. You can set your chassis to operate in AC Redundancy mode with fewer than six PSUs, but it will operate in a degraded state.

In AC Redundancy mode, all six PSUs will be active. Three of the PSUs connect to one AC power grid, while the other three connect to another AC power grid. When the system is running optimally in AC Redundancy mode, all the PSUs share the load.

 **NOTICE:** To avoid a system failure and for AC Redundancy to work effectively, you must ensure that each set of PSUs is connected to a separate AC grid.

In case one AC grid fails, the three PSUs on the functioning AC grid take over without interruption to the servers or infrastructure.

 **NOTICE:** In AC Redundancy mode, a difference in the number of PSUs between the two AC grids (for example, three PSUs on one AC grid and two on the other AC grid) will cause a degradation in the redundancy.

## **Power Supply Redundancy**

The capacity of the highest-rated PSU in the chassis is kept as a spare, ensuring that a failure of any one PSU will not cause the servers or chassis to power-down.

Power Supply Redundancy mode does not utilize all six PSUs; it uses maximum of four and a minimum of two.

Failure of two PSUs may cause some or all servers in the chassis to power down.



## No Redundancy

Power from up to three PSUs is used to power on the entire chassis, including the servers, IOMs, iKVM, front panel LCD, fans, and primary CMC.



**NOTICE:** The No Redundancy mode uses only three PSUs at a time, without backup. Failure of one of the three PSUs being used could cause servers to lose power and data.

## Power Conservation and Power Budget Changes

The CMC can perform power conservation when the user-configured maximum power limit is reached. Power conservation is disabled by default. When you enable power conservation mode and the demand for power exceeds the power limit you have set, the CMC reduces power to servers you assign a lower priority to free power for higher priority servers and other modules in the chassis.

If all or multiple slots in the chassis are configured with the same priority level, the CMC decreases power to servers by increasing slot number order. For example, if the servers in slots 1 and 2 have the same priority level, the power for the server in slot 1 is decreased before that of the server in slot 2.



**NOTE:** To enable power conservation mode, see "Configuring Power Budget and Redundancy" on page 213.



**NOTE:** You can assign a priority level to each of the servers in the chassis by giving it a number from 1 through 9 inclusive. The default priority level for all servers is 5. The lower the number, the higher the priority level. For instructions on assigning server priority levels, see "Using RACADM" on page 215.

## PSU Failure With a No Redundancy Policy

In power conservation mode, the CMC decreases power to servers when an insufficient power event occurs, such as a PSU failure. The CMC initiates power conservation only when the redundancy policy is set to No Redundancy, because there may not be enough power for the chassis after a PSU fails. After decreasing power on servers, the CMC re-evaluates the power needs of the chassis. Power for higher priority servers is restored incrementally while power needs remain within the power budget.



**NOTE:** To set the redundancy policy, see "Configuring Power Budget and Redundancy" on page 213.

**Figure 8-2. AC Redundancy (top), and Power Supply Redundancy (bottom)**

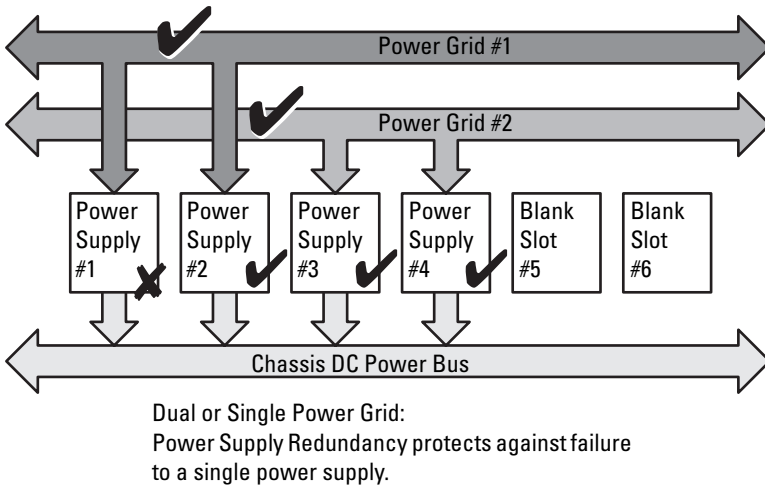
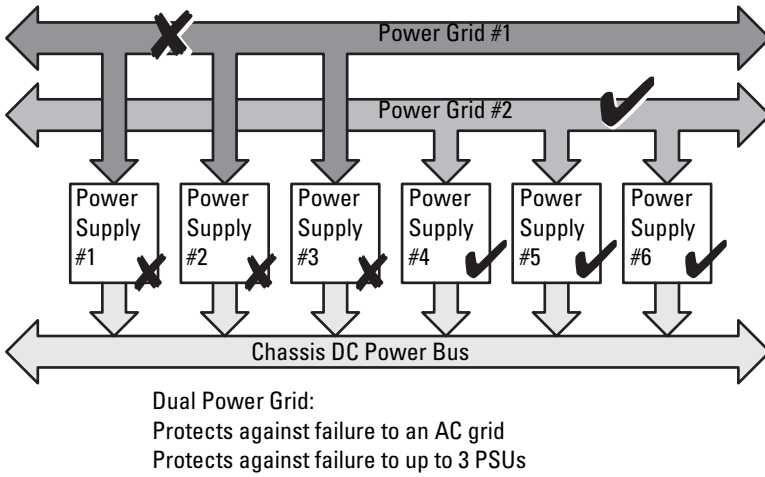

**Figure 8-3. No Redundancy**

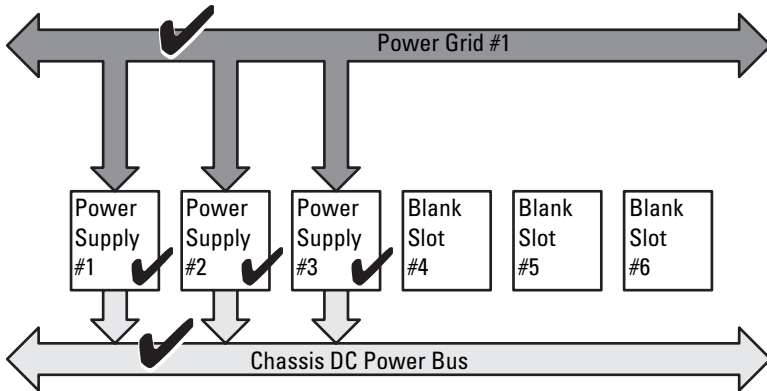

Single Power Grid:  
No protection against grid or power supply failure

### **New Server Engagement Policy**

When a new server is powered on, the CMC may need to decrease power to lower priority servers to allow more power for the new server if adding the new server exceeds the power available for the system. This could happen if the administrator has configured a power limit for the chassis that is below what would be required for full power allocation to the servers, or if fewer than three power supplies are in the chassis. If enough power cannot be freed by throttling lower priority servers the new server may not be allowed to start.

The highest sustained power required to run the chassis and all of the servers, including the new one, at full power is the worst case power requirement. If that amount of power is available, no servers are throttled and the new server is allowed to start up.

If the worst case power requirement is not available, power conservation mode is activated. Power is reduced to the lower priority servers until enough power is freed to start the new server.

- If enough power cannot be freed by reducing power to the existing servers, the new server is not allowed to start up.
- If enough power is freed by reducing power to the existing servers, the freed power is allocated to the new server and the server is allowed to start.

Table 8-3 describes the actions taken by the CMC when a new server is powered on in the scenario described above.

**Table 8-3. CMC Response When a Server Power-On is Attempted**

<b>Worst Case Power is Available</b>	<b>CMC Response</b>	<b>Server Power On</b>
Yes	No power conservation is required	Allowed
No	Perform power conservation: <ul style="list-style-type: none"> <li>• Power required for new server is available</li> <li>• Power required for new server is not available</li> </ul>	Allowed Disallowed

Table 8-4 describes the firmware response to a PSU power down or removal as it applies to various PSU redundancy configurations.

**Table 8-4. Chassis Impact from PSU Failure or Removal**

<b>PSU Configuration</b>	<b>Dynamic PSU Engagement</b>	<b>Firmware Response</b>
AC Redundancy	Disabled	Power conservation not initiated. User alerted of loss of AC Redundancy.
Power Supply Redundancy	Disabled	Power conservation not initiated. User alerted of loss of Power Supply Redundancy.
No Redundancy	Disabled	Decrease power to low priority servers.
AC Redundancy	Enabled	Power conservation not initiated. User alerted of loss of AC Redundancy if all PSUs in chassis were engaged and powered up. PSU in standby mode (if any) is turned on to compensate for power budget lost by PSU powered off.
Power Supply Redundancy	Enabled	Power conservation not initiated. User alerted of loss of Power Supply Redundancy if all PSU in chassis were engaged and powered up. PSU in standby mode (if any) is turned on to compensate from power budget lost by PSUs powered off.
No Redundancy	Enabled	Decrease power to low priority servers.

## **PSU Power-downs and Removals With a No Redundancy Policy**

The CMC may begin conserving power when you power-down or gracefully extract a PSU. The CMC decreases power to the lower priority servers until power consumption is supported by the remaining PSUs in the chassis. If you power-down or remove more than one PSU, the CMC evaluates power needs again when the second PSU is removed to determine the firmware response.

### **Limits**

- The CMC does not support *automated* power-down of a lower priority server to allow power up of a higher priority server; however, you can perform user-initiated power-downs.
- Changes to the PSU redundancy policy are limited by the number of PSUs in the chassis. The M1000e chassis ships with one of two configurations: three PSUs or six PSUs. You can select any of the three PSU redundancy configuration settings listed in "Redundancy Policies" on page 199. However, some redundancy policies, such as AC Redundancy, are not available for chassis with fewer than six PSUs (the maximum number allowable per chassis).

## **Configuring and Managing Power**

You can use the Web-based and RACADM interfaces to manage and configure power controls on the CMC. Specifically, you can:

- View power budget status for the chassis, servers, and PSUs
- Configure power budget and redundancy for the chassis and all chassis components (chassis, servers, IOMs, iKVM, primary and standby CMC, and PSUs)
- Execute power control operations (power-on, power-off, system reset, power-cycle) the chassis

### **Viewing the Health Status of the PSUs**

The **Power Supply Status** page displays the status and readings of the PSUs associated with the chassis. For more information about CMC power management, see "Power Management" on page 197.



## Using the Web Interface

To view the health status of the PSUs:

- 1 Log in to the CMC Web interface.
- 2 Select **Power Supplies** in the system tree. The **Power Supply Status** page displays.

Table 8-5 provides descriptions of the information provided on the **Power Supply Status** page.

**Table 8-5. Power Supply Health Status Information**

Item	Description
Present	Indicates whether the PSU is <b>Present</b> or <b>Absent</b> .
Health	 OK Indicates that the PSU is present and communicating with the CMC. In the event of a communication failure between the CMC and the fan unit, the CMC cannot obtain or display health status for the PSU.
	 Warning Indicates that only Warning alerts have been issued, and corrective action must be taken within the time frame set by the administrator. If corrective actions are not taken within the administrator-specified time, it could lead to critical or severe power failures that can affect the integrity of the chassis.
	 Severe Indicates at least one Failure alert has been issued. Failure status indicates a power failure on the chassis, and <b>corrective action must be taken immediately</b> .
Name	Displays the name of the PSU: PS- <i>n</i> , where <i>n</i> is the power supply number.
Power Status	Indicates the power state of the PSU: <b>Online</b> , <b>Off</b> , <b>Redundant</b> , <b>Standby</b> , or <b>Slot Empty</b> .
Capacity	Displays the power capacity in watts.

## Using RACADM

See Viewing Power Budget Status below.

## Viewing Power Budget Status

The CMC provides power status overviews of the power subsystem on the **Power Budget Status** page.

### Using the Web Interface

 **NOTE:** To perform power management actions, you must have **Chassis Control Administrator** privilege.

- 1 Log in to the CMC Web interface.
- 2 Select **Chassis** in the system tree.
- 3 Click the **Power Management** tab. The **Power Budget Status** page displays.

Table 8-6 through Table 8-11 describe the information displayed on the **Power Budget Status** page.

See "Configuring Power Budget and Redundancy" on page 213 for information about configuring the settings for this information.

### Using RACADM

Open a Telnet/SSH text console to the CMC, log in, and type:

```
racadm getpbinfo
```

 **NOTE:** For more information about **getpbinfo**, including output details, see "getpbinfo" on page 311.

**Table 8-6. Real-Time Power Statistics**

Item	Description
Actual System AC Power Consumption	Indicates the current cumulative AC power consumption of all modules in the chassis measured from the AC input side of the PSUs. Overall range: 0–7928 watts
Peak System Power Consumption	Indicates the maximum system level AC power consumption (in watts) since the value was last cleared by a user. This property allows you to track the maximum power consumption by the system (chassis and modules) recorded over a period of time. To clear this value, click the <b>Configuration</b> sub-tab of the <b>Budget Status</b> page.

**Table 8-6. Real-Time Power Statistics (continued)**

<b>Item</b>	<b>Description</b>
Peak System Power Consumption Timestamp	Displays the date and time recorded when the peak system power consumption value occurred over the time period being recorded. The timestamp is displayed in the format <b>hh:mm:ss MM/DD/YYYY</b> , where <b>hh</b> is hours (0–24), <b>mm</b> is minutes (00–60), <b>ss</b> is seconds (00–60), <b>MM</b> is the month (1–12), <b>DD</b> is the day, 1–31, and <b>YYYY</b> is the year.
Minimum System Power Consumption	Displays the minimum system level AC power consumption value (in watts) over the time since the user last cleared this value. This property allows you to track the minimum power consumption by the system (chassis and modules) recorded over a period of time. To clear this value, click the <b>Configuration</b> sub-tab on the <b>Budget Status</b> page.
Minimum System Power Consumption Timestamp	Displays the date and time recorded when the minimum system power consumption occurred over the time period being recorded. The format of the timestamp is the same as described for <b>Peak System Power Consumption Timestamp</b> .

**Table 8-7. System Power Status**

<b>Item</b>	<b>Description</b>
Overall Power Health	Indicates the health status ( <b>OK</b> , <b>Non-Critical</b> , <b>Critical</b> , <b>Non-Recoverable</b> , <b>Other</b> , <b>Unknown</b> ) of the chassis' power subsystem.
System Power Status	Displays the power status ( <b>On</b> , <b>Off</b> , <b>Powering On</b> , <b>Powering Off</b> ) of the chassis.
Redundancy	Indicates the power supply redundancy status. Valid values are: <b>No</b> — PSUs are not redundant <b>Yes</b> — full redundancy in effect



**Table 8-8. System Power Policy Configuration**

<b>Item</b>	<b>Description</b>
System Max AC Power Limit	Displays the user-defined maximum power consumption limit for the entire system (chassis, CMCs, servers, I/O modules, PSUs, iKVM, and fans). The CMC enforces this limit by throttling (if enabled) or by powering off lower priority servers (if throttling is not enabled).
System AC Power Warning Threshold	<p>Displays the maximum amount of power, in watts, beyond which the CMC takes action to reduce power consumption.</p> <p>If <b>Server Power Throttling Enabled</b> is checked, and the chassis power consumption exceeds the power warning threshold, then the performance of lower priority servers is reduced until total power consumption falls below the threshold.</p> <p>If <b>Server Power Throttling Enabled</b> is not checked, servers with lower priority may be powered off until total power consumption falls below the threshold.</p>
Server Power Throttling Enabled	Enables the user to configure the system to compromise server performance to conserve power if the available power is reduced.

**Table 8-8. System Power Policy Configuration (continued)**

Item	Description
Redundancy Policy	<p data-bbox="292 284 949 336">Indicates the current redundancy configuration: AC Redundancy, Power Supply Redundancy, and No Redundancy.</p> <p data-bbox="292 352 949 523"><b>AC Redundancy</b> — Power input is load-balanced across all PSUs. Three of the PSUs are connected to one AC grid and the other three are connected to another grid. When the system is running optimally in AC Redundancy mode, power is load-balanced across all active supplies. In case of a grid failure, the PSUs on the functioning AC grid take over at 100% capacity.</p> <p data-bbox="292 539 949 651"><b>NOTE:</b> In AC Redundancy mode, a difference in the number of PSUs between the two AC circuits (for example, three PSUs on one AC circuit and two on the other AC circuit) causes a degradation in the system redundancy.</p> <p data-bbox="292 667 949 751"><b>Power Supply Redundancy</b> — The capacity of the highest-rated PSU in the chassis is held as spare, ensuring that a failure of any one PSU does not cause the server modules or chassis to power down.</p> <p data-bbox="292 767 949 852"><b>Power Supply Redundancy</b> mode does not use all six PSUs; it uses a maximum of four. PSUs in excess of four do not participate in <b>Power Supply Redundancy</b> unless a PSU fails or is removed.</p> <p data-bbox="292 868 949 952"><b>No Redundancy</b> — The power from all three PSUs on one AC circuit (grid) is used to power the entire chassis, including the chassis, servers, I/O modules, iKVM, and CMC.</p> <p data-bbox="292 968 949 1053"> <b>NOTICE:</b> The <b>No Redundancy</b> mode uses only three PSUs at a time, with no backup. Failure of one of the three PSUs in use could cause the server modules to lose power and data.</p>
Dynamic PSU Engagement Enabled	<p data-bbox="292 1074 949 1244">Indicates whether <b>Dynamic Power Supply Engagement</b> is enabled or disabled. Enabling this feature allows the CMC to put under-utilized PSUs into standby mode based on the redundancy policy that is set and the power requirements of the system. Putting under-utilized PSUs into standby mode increases the utilization, and efficiency, of the online PSUs, saving power.</p>

**Table 8-9. Power Budgeting**

<b>Item</b>	<b>Description</b>
System DC Max Power Capacity	Displays the Maximum DC power, in watts, the available PSUs can supply to the system.
DC Redundancy Reserve	Indicates the amount of redundant power (in watts) in reserve that can be utilized in the event of an AC grid or PSU failure.  When the chassis is configured to operate in <b>AC Redundancy</b> mode, the <b>DC Redundancy Reserve</b> is the amount of reserve power that can be utilized in the event of an AC grid failure.  When the chassis is configured to operate in <b>Power Supply Redundancy</b> mode, the <b>DC Redundancy Reserve</b> is the amount of reserve power that can be utilized in the event of a specific PSU failure.
DC Power Allocated to Servers	Indicates the cumulative DC power, in watts, the CMC is allocated to servers based on their configuration.
DC Power Allocated to Chassis Infrastructure	Indicates the cumulative DC power, in watts, the CMC is allocating to the chassis infrastructure (fans, IO modules, iKVM, CMC, standby CMC, and iDRACs on the servers).
Total DC Power Available for Allocation	Indicates the total chassis power budget, in watts, available for chassis operation.
Standby DC Power Capacity	Indicates the amount of power, in watts, available to be provided by the PSUs that are in standby mode. This power can be allocated to any hardware modules that are either added to the chassis or brought online.

**Table 8-10. Server Modules**

<b>Item</b>	<b>Description</b>
Slot #	Displays the location of the server module. The <b>Slot #</b> is a sequential number (1–16) that identifies the server module by its location within the chassis.
Name	Displays the server name. The server name can be redefined by the user.
Type	Displays the type of the server.
Priority	Indicates the priority level allotted to the server slot in the chassis for power budgeting. The CMC uses this value in its calculations when power must be reduced or reallocated based on user-defined power limits or power supply or power grid failures. <b>Priority levels:</b> 1 (highest) through 9 (lowest) <b>Default:</b> 5 <b>NOTE:</b> Server slot priority level is associated with the server slot—not with the server inserted into the slot. If you move a server to a different slot in the chassis or to a different chassis, the priority previously associated with new slot determines the priority of the relocated server.
Power State	Indicates the current state of the server, <b>ON</b> or <b>OFF</b> .
Budget Allocation	Indicates the power budget allocation for the server module.

**Table 8-11. System Power Supplies**

<b>Item</b>	<b>Description</b>
Name	Displays the name of the PSU in the format <b>PS-<i>n</i></b> , where <i>n</i> , is the PSU number.
Power State	Indicates the power state of the PSU — <b>On, Initializing, Online, Stand By, In Diagnostics, Failed, Redundant, Unknown, or Absent</b> (missing).
Capacity	Displays the maximum DC power rating of the PSU.

## Configuring Power Budget and Redundancy

The CMC's power management service optimizes power consumption for the entire chassis (the chassis, servers, IOMs, iKVM, CMC, and PSUs) and re-allocates power to different modules based on the demand.

### Using the Web Interface



**NOTE:** To perform power management actions, you must have **Chassis Control Administrator** privilege.

- 1** Log in to the CMC Web interface.
- 2** Select **Chassis** in the system tree.
- 3** Click the **Power Management** tab. The **Power Budget Status** page displays.
- 4** Click the **Configuration** sub-tab. The **Budget/Redundancy Configuration** page displays.
- 5** Set any or all of the properties described in Table 8-12 according to your needs.
- 6** Click **Apply** to save your changes.

To refresh the content on the **Budget/Redundancy Configuration** page, click **Refresh**. To print the contents, click **Print**.

**Table 8-12. Configurable Power Budget/Redundancy Properties**

Item	Description
System Max AC Power Limit	<p data-bbox="351 301 958 501">Indicates the user-defined maximum power consumption limit for the entire system (chassis, CMC, servers, I/O modules, power supply units, iKVM, and fans). The CMC will enforce this limit when power conservation mode is enabled (by checking <b>Server Power Throttling Enabled</b>), or by powering off lower priority server modules if power conservation mode is not enabled.</p> <p data-bbox="351 517 958 632">The power budget is limited to a maximum of three PSUs out of a total of six PSUs. If you attempt to set an AC power budget value that exceeds the power capacity of your chassis, the CMC will display a failure message.</p> <p data-bbox="351 647 736 671"><b>Configuration range:</b> 2768–7928 watts</p> <p data-bbox="351 687 549 711"><b>Default:</b> 7928 watts</p>
System AC Power Warning Threshold	<p data-bbox="351 730 958 785">Indicates the maximum amount of power (in watts) beyond which the CMC takes action to reduce power consumption.</p> <p data-bbox="351 801 958 916">If <b>Server Power Throttling Enabled</b> is checked and the chassis power consumption exceeds the power warning threshold, then the power to lower priority servers is reduced until the total power consumption falls below the threshold.</p> <p data-bbox="351 932 958 1015">If <b>Server Power Throttling Enabled</b> is <i>not</i> checked, servers with lower priority may be powered off until the total power consumption falls below the threshold.</p>
Server Power Throttling Enabled	<p data-bbox="351 1034 958 1174">When checked, enables the CMC power conservation mode. The CMC is allowed to siphon power from lower priority servers when power is needed for the entire chassis. Servers continue operating at a reduced performance level rather than being shut down.</p>

**Table 8-12. Configurable Power Budget/Redundancy Properties (continued)**

Item	Description
Redundancy Policy	<p>Specifies a redundancy configuration: No Redundancy, Power Supply Redundancy, or AC Redundancy.</p> <p>Default: No Redundancy.</p> <p><b>NOTE:</b> The <b>No Redundancy</b> mode uses only three PSUs at a time. If 3 PSUs are installed, then no backup is available. Failure of one of the three PSUs in use could cause the servers to lose power or data. If PSUs 4 through 6 are present, then they become redundant and are made available if an online PSU fails.</p>
Dynamic PSU Engagement Enabled	<p>Indicates whether Dynamic Power Supply Engagement is enabled or disabled. Enabling this feature allows the CMC to put under-utilized power supplies into standby mode based on the redundancy policy that is set and the power requirements of the system. Putting under-utilized power supplies into standby mode increases the utilization of active power supplies and thus the efficiency of the online supplies, saving power.</p>
Disable Chassis Power Button	<p>Disables (when checked) the chassis power button. If the check box is checked and the user attempts to change the power state of the chassis through the chassis power button, the action is ignored.</p>

## Using RACADM

To enable redundancy and set the redundancy policy:



**NOTE:** To perform power management actions, you must have **Chassis Control Administrator** privilege.

- 1 Open a Telnet/SSH text console to the CMC and log in.
- 2 Set properties as needed:
  - To set the maximum power budget for the chassis, type:

```
racadm config -g cfgChassisPower -o  
cfgChassisMaxACPowerLimit <value>
```

where <value> is a number between 2768–7928 representing the maximum power limit in watts. The default is 7928.

For example, the following command:

```
racadm config -g cfgChassisPower -o  
cfgChassisMaxACPowerLimit 5400
```

sets the maximum power budget to 5400 watts.

- To set the power warning threshold, type:

```
racadm config -g cfgChassisPower -o  
cfgChassisACPowerWarningThreshold <value>
```

where <value> is a number between 2768–7928 (inclusive) representing the power consumption limit in watts beyond which a warning is issued. The default is 7928.

For example, the following command:

```
racadm config -g cfgChassisPower -o  
cfgChassisACPowerWarningThreshold 5400
```

sets the maximum power budget to 5400 watts.

- To enable or disable power conservation mode (server throttling), type:

```
racadm config -g cfgChassisPower -o  
cfgChassisServerPowerThrottling <value>
```

where <value> is 0 (disable), 1 (enable). The default is 1.

For example, the following command:

```
racadm config -g cfgChassisPower -o  
cfgChassisServerPowerThrottling 0
```

disables server power throttling.

- To select a redundancy policy, type:

```
racadm config -g cfgChassisPower -o  
cfgChassisRedundancyPolicy <value>
```

where <value> is 0 (No Redundancy), 1 (AC Redundancy), 2 (Power Supply Redundant). The default is 0.



For example, the following command:

```
racadm config -g cfgChassisPower -o  
cfgChassisRedundancyPolicy 1
```

sets the redundancy policy to 1.

- To enable or disable dynamic PSU engagement, type:  

```
racadm config -g cfgChassisPower -o  
cfgChassisDynamicPSUEngagementEnable <value>
```

where *<value>* is 0 (disable), 1 (enable). The default is 1.

For example, the following command:

```
racadm config -g cfgChassisPower -o  
cfgChassisDynamicPSUEngagementEnable 0
```

disables dynamic PSU engagement.

For information about RACADM commands for chassis power:

- See "config" on page 290
- See "getconfig" on page 299
- See "getpbinfo" on page 311
- See "cfgChassisPower" on page 375

## Assigning Priority Levels to Servers

Server priority levels determine which servers the CMC draws power from when additional power is required.



**NOTE:** The priority you assign to a server is linked to its slot and not to the server itself. If you move the server to a new slot, you must reconfigure the priority from the new slot location.



**NOTE:** To perform power management actions, you must have **Chassis Configuration Administrator** privilege.

## Using the Web Interface

- 1 Log in to the CMC Web interface.
- 2 Select **Servers** in the system tree. The **Servers Status** page appears.

- 3 Click the **Power Management** tab. The **Server Priority** page appears, listing all of the servers in your chassis.
- 4 Select a priority level (1–9, with 1 holding the highest priority) for one, multiple, or all servers. You can assign the same priority level to multiple servers.
- 5 Click **Apply** to save your changes.

### Using RACADM

Open a Telnet/SSH text console to the CMC, log in, and type:

```
racadm config -g cfgServerInfo -o cfgServer Priority  
-i <slot number> <priority level>
```

Where *<slot number>* (1–16) refers to the location of the server, and *<priority level>* is a value between 1–9.

For example, the following command:

```
racadm config -g cfgServerInfo -o cfgServer Priority  
-i 5 1
```

sets the priority level to 1 for the server with the index name of 5.

### Setting the Power Budget



**NOTE:** To perform power management actions, you must have **Chassis Control Administrator** privilege.

### Using the Web Interface

- 1 Log in to the CMC Web interface.
- 2 Click **Chassis** in the system tree. The **Component Health** page appears.
- 3 Click the **Power Management** tab. The **Power Budget Status** page appears.
- 4 Click the **Configuration** sub-tab. The **Budget/Redundancy Configuration** page appears.

- 5 Type a budget value of up to 7928 watts in the **Enclosure Max Power Limit** text field.

 **NOTE:** The power budget is limited to a maximum of three PSUs out of a total of six PSUs. If you attempt to set a AC power budget value that exceeds the power capacity of your chassis, the CMC will display a failure message.

- 6 Click **Apply** to save your changes.

### Using RACADM

Open a Telnet/SSH text console to the CMC, log in, and type:

```
racadm config -g cfgChassisPower -o  
cfgChassisMaxACPowerLimit <value>
```

where *<value>* is the maximum amount of power (in watts) available to the chassis.

 **NOTE:** The power budget is limited to a maximum of three PSUs out of a total of six PSUs. If you attempt to set a AC power budget value that exceeds the power capacity of your chassis, the CMC will display a failure message.

For example:

```
racadm config -g cfgChassisPower -o  
cfgChassisMaxACPowerLimit 7928
```

### Setting the Power Warning Threshold

 **NOTE:** To perform power management actions, you must have **Chassis Control Administrator** privilege.

### Using the Web Interface

- 1 Log in to the CMC Web interface.
- 2 Click **Chassis** in the system tree. The **Component Health** page appears.
- 3 Click the **Power Management** tab. The **Power Budget Status** page appears.
- 4 Click the **Configuration** sub-tab. The **Budget/Redundancy Configuration** page appears.
- 5 Type a budget value (less than that of the **Enclosure Max Power Limit**) in the **Power Warning Threshold** text field.
- 6 Click **Apply** to save your changes.

## Using RACADM

Open a Telnet/SSH text console to the CMC, log in, and type:

```
racadm config -g cfgChassisPower -o  
cfgChassisACPowerWarningThreshold <value>
```

where <value> is the upper wattage limit beyond which a warning is generated by the CMC. This value should be less than that of the Power Budget (see previous steps).

## Enabling Throttling to Maintain Power Budget



**NOTE:** To perform power management actions, you must have **Chassis Control Administrator** privilege.

Throttling selected services is an optional configuration for the No Redundancy policy. Throttling allows the CMC to draw power from lower priority servers when additional power is needed to maintain the maximum AC power limit.

For example, when a new server is engaged, the CMC may decrease power to low priority servers to allow more power for the new server. If the amount of power is still insufficient after throttling the lower priority servers, the CMC will throttle higher priority servers until sufficient power is freed to power the new server.

Throttling is executed in two cases:

- Overall power consumption exceeds the configurable maximum power limit (see "Setting the Power Budget" on page 218)
- A power failure occurs in a non-redundant configuration

For information about assigning priority levels to servers, see "Executing Power Control Operations on the Chassis" on page 221.

## Using the Web Interface

- 1 Log in to the CMC Web interface.
- 2 Click **Chassis** in the system tree. The **Component Health** page appears.
- 3 Click the **Power Management** tab. The **Power Budget Status** page appears.
- 4 Click the **Configuration** sub-tab. The **Budget/Redundancy Configuration** page appears.

- 5 Select the **Server Power Throttling Enabled** check box.
- 6 Click **Apply** to save your changes.

### Using RACADM

Open a Telnet/SSH text console to the CMC, log in, and type:

```
racadm config -g cfgChassisPower -o  
cfgChassisServerPowerThrottling <option>
```

where <option> is 0 (disable), or 1 (enable).

### Executing Power Control Operations on the Chassis



**NOTE:** To perform power management actions, you must have **Chassis Control Administrator** privilege.



**NOTE:** Power control operations affect the entire chassis. For power control operations on an IOM, see "Executing Power Control Operations on an IOM" on page 222. For power control operations on servers, see "Executing Power Control Operations on a Server" on page 223.

The CMC enables you to remotely perform several power management actions, such as an orderly shutdown, on the entire chassis (chassis, servers, IOMs, iKVM, and PSUs).

### Using the Web Interface

- 1 Log in to the CMC Web interface.
  - 2 Select **Chassis** in the system tree.
  - 3 Click the **Power Management** tab. The **Power Budget Status** page displays.
  - 4 Click the **Control** sub-tab. The **Power Management** page displays.
  - 5 Select one of the following **Power Control Operations** by clicking its radio button:
    - **Power On System** — Turns on the system power.
    - **Power Off System** — Turns off the system power.
    - **Reset CMC** — Resets the CMC without powering off (warm reboot). (This option is disabled if the CMC is already powered off).
-  **NOTE:** This action only resets the CMC. No other components are affected.
- **Power Cycle System** — Power off, then reboot (cold boot) the system.

- 6 Click **Apply**. A dialog box appears requesting confirmation.
- 7 Click **OK** to perform the power management action (for example, cause the system to reset).

### Using RACADM

Open a Telnet/SSH text console to the CMC, log in, and type:

```
racadm chassisaction -m chassis <action>
```

where <action> is `powerup`, `powerdown`, `powercycle`, or `reset`.

### Executing Power Control Operations on an IOM

You can remotely execute a reset or power cycle on an individual IOM.



**NOTE:** To perform power management actions, you must have **Chassis Control Administrator** privilege.

### Using the Web Interface

- 1 Log in to the CMC Web interface.
- 2 Select **I/O Modules**. The **I/O Modules Status** page displays.
- 3 Click the **Power Management** tab. The **Power Control** page displays.
- 4 Select the operation you want to execute (**reset** or **power cycle**) from the drop-down menu beside the IOM in the list.
- 5 Click **Apply**. A dialog box appears requesting confirmation.
- 6 Click **OK** to perform the power management action (for example, cause the IOM to power cycle).

### Using RACADM

Open a Telnet/SSH text console to the CMC, log in, and type:

```
racadm chassisaction -m switch<n> <action>
```

where <n> specifies the IOM by its slot number (1–6), and <action> indicates the operation you want to execute: `powercycle` or `reset`.

## Executing Power Control Operations on a Server



**NOTE:** To perform power management actions, you must have **Chassis Control Administrator** privilege.

The CMC enables you to remotely perform several power management actions, for example, an orderly shutdown, on an individual server in the chassis.

### Using the Web Interface

- 1 Log in to the CMC Web interface.
- 2 Expand **Servers** in the system tree, and then select the server on which you want to execute a power control operation. The **Server Status** page displays.
- 3 Click the **Power Management** tab. The **Server Power Management** page displays.
- 4 Select one of the following **Power Control Operations** by clicking its radio button:
  - **Power On System** — Turns on the system power (equivalent to pressing the power button when the system power is off). This option is disabled if the server is already powered on.
  - **Power Off System** — Turns off the system power (equivalent to pressing the power button when the system power is on).
  - **Graceful Shutdown** — Powers off and then reboots the server.
  - **Reset System (warm boot)** — Reboots the server without powering off. This option is disabled if the server is powered off.
  - **Power Cycle System (cold boot)** — Powers off and then reboots the server. This option is disabled if the server is powered off.
- 5 Click **Apply**. A dialog box appears requesting confirmation.
- 6 Click **OK** to perform the power management action (for example, cause the server to reset).

## Using RACADM

Open a Telnet/SSH text console to the CMC, log in, and type:

```
racadm serveraction -m <module> <action>
```

where <module> specifies the server by its slot number (1–16) in the chassis, and <action> indicates the operation you want to execute: powerup, powerdown, powercycle, or hardreset.



# Using the iKVM Module

## Overview

The local access KVM module for your Dell™ M1000e server chassis is called the Avocent® Integrated KVM Switch Module, or iKVM. The iKVM is an analog keyboard, video, and mouse switch that plugs into your chassis. It is an optional, hot-pluggable module to the chassis that provides local keyboard, mouse, and video access to the servers in the chassis, and to the active CMC's command line.

## iKVM User Interface

The iKVM uses the On Screen Configuration and Reporting (OSCAR®) graphical user interface, which is activated by a hot key. OSCAR allows you to select one of the servers or the Dell CMC command line you wish to access with the local keyboard, display, and mouse.

Only one iKVM session per chassis is allowed.

## Security

The OSCAR user interface allows you to protect your system with a screen saver password. After a user-defined time, the screen saver mode engages, and access is prohibited until the appropriate password is entered to reactivate OSCAR.

## Scanning

OSCAR allows you to select a list of servers, which are displayed in the order selected while OSCAR is in scan mode.

## Server Identification

The CMC assigns slots names for all servers in the chassis. Although you can assign names to the servers using the OSCAR interface from a tiered connection, the CMC assigned names take precedence, and any new names you assign to servers using OSCAR will be overwritten.

The CMC identifies a slot by assigning it a unique name. To change slot names using the CMC Web interface, see "Editing Slot Names" on page 91. To change a slot name using RACADM, see "setslotname" on page 339.

## Video

The iKVM video connections support video display resolutions ranging from 640 x 480 at 60 Hz up to 1280 x 1024 at 60 Hz.

## Plug and Play

The iKVM supports Display Data Channel (DDC) Plug and Play, which automates video monitor configuration, and is compliant with the VESA DDC2B standard.

## FLASH Upgradable

You can update the iKVM firmware using the CMC Web interface or RACADM `fwupdate` command. For more information, see "Managing iKVM From the CMC" on page 243.

# Physical Connection Interfaces

You can connect to a server or the CMC CLI console via the iKVM from the chassis front panel, an Analog Console Interface (ACI), and the chassis rear panel.



**NOTE:** The ports on the control panel on the front of the chassis are designed specifically for the iKVM, which is optional. If you do not have the iKVM, you cannot use the front control panel ports.

## iKVM Connection Precedences

Only one iKVM connection is available at a time. The iKVM assigns an order of precedence to each type of connection so that when there are multiple connections, only one connection is available while others are disabled.

The order of precedence for iKVM connections is as follows:

- 1 Front panel
- 2 ACI
- 3 Rear Panel

For example, if you have iKVM connections in the front panel and ACI, the front panel connection remains active while the ACI connection is disabled. If you have ACI and rear connections, the ACI connection takes precedence.

## Tiering Through the ACI Connection

The iKVM allows tiered connections with servers and the iKVM's CMC command line console, either locally through a Remote Console Switch port or remotely through the Dell RCS<sup>®</sup> software. The iKVM supports ACI connections from the following products:

- 180AS, 2160AS, 2161DS-2\*, or 4161DS Dell Remote Console Switches™
- Avocent AutoView<sup>®</sup> switching system
- Avocent DSR<sup>®</sup> switching system
- Avocent AMX<sup>®</sup> switching system

\* Does not support the Dell CMC console connection.



**NOTE:** The iKVM also supports an ACI connection to the Dell 180ES and 2160ES, but the tiering is non-seamless. This connection requires a USB to PS2 SIP.

## Using OSCAR

This section provides an overview of the OSCAR interface.

### Navigation Basics

Table 9-1 describes navigating the OSCAR interface using the keyboard and mouse.

**Table 9-1. OSCAR Keyboard and Mouse Navigation**

Key or Key Sequence	Result
<ul style="list-style-type: none"> <li>• &lt;Print Screen&gt;-&lt;Print Screen&gt;</li> <li>• &lt;Shift&gt;-&lt;Shift&gt;</li> <li>• &lt;Alt&gt;-&lt;Alt&gt;</li> <li>• &lt;Ctrl&gt;-&lt;Ctrl&gt;</li> </ul>	Any of these key sequences can open OSCAR, depending on your <b>Invoke OSCAR</b> settings. You can enable two, three, or all of these key sequences by selecting boxes in the <b>Invoke OSCAR</b> section of the <b>Main</b> dialog box, and then clicking <b>OK</b> .
<F1>	Opens the <b>Help</b> screen for the current dialog box.

**Table 9-1. OSCAR Keyboard and Mouse Navigation (continued)**

<b>Key or Key Sequence</b>	<b>Result</b>
<Esc>	<p>Closes the current dialog box without saving changes and returns to the previous dialog box.</p> <p>In the <b>Main</b> dialog box, &lt;Esc&gt; closes the OSCAR interface and returns to selected server.</p> <p>In a message box, it closes the pop-up box and returns to the current dialog box.</p>
<Alt>	Opens dialog boxes, selects or checks options, and executes actions when used in combination with underlined letters or other designated characters.
<Alt>+<X>	Closes the current dialog box and returns to the previous dialog box.
<Alt>+<O>	Selects the <b>OK</b> button, then returns to the previous dialog box.
<Enter>	Completes a switch operation in the <b>Main</b> dialog box and exits OSCAR.
Single-click, <Enter>	In a text box, selects the text for editing and enables the left-arrow key and right-arrow keys to move the cursor. Press <Enter> again to quit the edit mode.
<Print Screen>, <Backspace>	Toggles back to previous selection if there were no other keystrokes.
<Print Screen>, <Alt>+<O>	Immediately disconnects a user from a server; no server is selected. Status flag displays Free. (This action only applies to the =<O> on the keyboard and not the keypad.)
<Print Screen>, <Pause>	Immediately turns on screen saver mode and prevents access to that specific console, if it is password protected.
Up/Down Arrow keys	Moves the cursor from line to line in lists.
Right/Left Arrow keys	Moves the cursor within the columns when editing a text box.
<Home>/<End>	Moves the cursor to the top (Home) or bottom (End) of a list.
<Delete>	Deletes characters in a text box.
Number keys	Type from the keyboard or keypad.
<Caps Lock>	Disabled. To change case, use the <Shift> key.

## Configuring OSCAR

Table 9-2 describes the features available from the OSCAR **Setup** menu for configuring your servers.

**Table 9-2. OSCAR Setup Menu Features**

<b>Feature</b>	<b>Purpose</b>
Menu	Changes the server listing between numerically by slot or alphabetically by name.
Security	<ul style="list-style-type: none"><li>• Sets a password to restrict access to servers.</li><li>• Enables a screen saver and set an inactivity time before the screen saver appears and set the screen save mode.</li></ul>
Flag	Changes display, timing, color, or location of the status flag.
Language	Changes the language for all OSCAR screens.
Broadcast	Sets up to simultaneously control multiple servers through keyboard and mouse actions.
Scan	Sets up a custom scan pattern for up to 16 servers.

To access the **Setup** dialog box:

- 1** Press <Print Screen> to launch the OSCAR interface. The **Main** dialog box appears.
- 2** Click **Setup**. The **Setup** dialog box appears.

### Changing the Display Behavior

Use the **Menu** dialog box to change the display order of servers and set a Screen Delay Time for OSCAR.

To access the **Menu** dialog box:

- 1** Press <Print Screen> to launch OSCAR. The **Main** dialog box appears.
- 2** Click **Setup** and then **Menu**. The **Menu** dialog box appears.

To choose the default display order of servers in the **Main** dialog box:

- 1 Select **Name** to display servers alphabetically by name.  
or  
Select **Slot** to display servers numerically by slot number.
- 2 Click **OK**.

To assign one or more key sequences for OSCAR activation:

- 1 Select a key sequence from the **Invoke OSCAR** menu.
- 2 Click **OK**.

The default key to invoke OSCAR is <Print Screen>.

To set a Screen Delay Time for the OSCAR:



- 1 Enter the number of seconds (0 through 9) to delay display of OSCAR after you press <Print Screen>. Entering <0> launches OSCAR with no delay.
- 2 Click **OK**.

Setting a time to delay display of OSCAR allows you to complete a soft switch. To perform a soft switch, see "Soft Switching" on page 234.

### Controlling the Status Flag

The status flag displays on your desktop and shows the name of the selected server or the status of the selected slot. Use the **Flag** dialog box to configure the flag to display by server, or to change the flag color, opacity, display time, and location on the desktop.

**Table 9-3. OSCAR Status Flags**

Flag	Description
	Flag type by name
	Flag indicating that the user has been disconnected from all systems
	Flag indicating that Broadcast mode is enabled

To access the **Flag** dialog box:

- 1 Press <Print Screen>. The **Main** dialog box appears.
- 2 Click **Setup** and then **Flag**. The **Flag** dialog box appears.

To specify how the status flag displays:

- 1 Select **Displayed** to show the flag all the time or **Displayed and Timed** to display the flag for only five seconds after switching.



**NOTE:** If you select **Timed** by itself, the flag is not displayed.

- 2 Select a flag color from the **Display Color** section. Options are black, red, blue, and purple.
- 3 In **Display Mode**, select **Opaque** for a solid color flag or **Transparent** to see the desktop through the flag.
- 4 To position the status flag on the desktop:
  - a Click **Set Position**. The **Set Position Flag** displays.
  - b Left-click on the title bar and drag it to the desired location on the desktop.
  - c Right-click to return to the **Flag** dialog box.



**NOTE:** Changes made to the flag position are not saved until you click **OK** in the **Flag** dialog box.

- 5 Click **OK** to save settings.  
To exit without saving changes, click .

## Managing Servers With iKVM

The iKVM is an analog switch matrix supporting up to 16 servers. The iKVM switch uses the OSCAR user interface to select and configure your servers. In addition, the iKVM includes a system input to establish a CMC command line console connection to the CMC.

### Peripherals Compatibility and Support

The iKVM is compatible with the following peripherals:

- Standard PC USB keyboards with QWERTY, QWERTZ, AZERTY, and Japanese 109 layouts.
- VGA monitors with DDC support.

- Standard USB pointing devices.
- Self-powered USB 1.1 hubs connected to the local USB port on the iKVM.
- Powered USB 2.0 hubs connected to the Dell M1000e chassis' front panel console.

 **NOTE:** You can use multiple keyboards and mice on the iKVM local USB port. The iKVM aggregates the input signals. If there are simultaneous input signals from multiple USB keyboards or mice, it may have unpredictable results.

 **NOTE:** The USB connections are solely for supported keyboard, mouse, and USB hubs. iKVM does not support data transmitted from other USB peripherals.

## Viewing and Selecting Servers

Use the OSCAR **Main** dialog box to view, configure, and manage servers through the iKVM. You can view your servers by name or by slot. The slot number is the chassis slot number the server occupies. The **Slot** column indicates the slot number in which a server is installed.

 **NOTE:** The Dell CMC command line occupies Slot 17. Selecting this slot displays the CMC command line, where you can execute remote RACADM commands or connect to servers and modules for debugging.

 **NOTE:** Server names and slot numbers are assigned by the CMC.

To access the **Main** dialog box:

Press <Print Screen> to launch the OSCAR interface. The **Main** dialog box appears.

or

If a password has been assigned, the **Password** dialog box appears. Type your password and click **OK**. The **Main** dialog box appears.

For more information about setting a password, see "Setting Console Security" on page 235.





 **NOTE:** There are four options for invoking OSCAR. You can enable one, multiple, or all of these key sequences by selecting boxes in the **Invoke OSCAR** section of the **Main** dialog box and then clicking **OK**.



## Viewing the Status of Your Servers

The status of the servers in your chassis is indicated in the right columns of the **Main** dialog box. The following table describe the status symbols.

**Table 9-4. OSCAR Interface Status Symbols**

<b>Symbols</b>	<b>Description</b>
	(Green dot.) Server is online.
	(Red X.) Server is offline or absent from chassis.
	(Yellow dot.) Server is not available.
	(Green A or B.) Server is being accessed by the user channel indicated by the letter: A=rear panel, B=front panel.

## Selecting Servers

Use the **Main** dialog box to select servers. When you select a server, the iKVM reconfigures the keyboard and mouse to the proper settings for that server.

- To select servers:

Double-click the server name or the slot number.

or

If the display order of your server list is by slot (that is, the **Slot** button is depressed), type the slot number and press <Enter>.

or

If the display order of your server list is by name (that is, the **Name** button is depressed), type the first few characters of the server name, establish it as unique, and press <Enter> twice.

- To select the previous server:

Press <Print Screen> and then <Backspace>. This key combination toggles between the previous and current connections.

- To disconnect the user from a server:

Press <Print Screen> to access OSCAR and then click **Disconnect**.

or

Press <Print Screen> and then <Alt><0>. This leaves you in a free state, with no server selected. The status flag on your desktop, if active, displays Free. See "Controlling the Status Flag" on page 230.

## Soft Switching

Soft switching is switching between servers using a hotkey sequence. You can soft switch to a server by pressing <Print Screen> and then typing the first few characters of its name or number. If you previously set a **delay time** (the number of seconds before the **Main** dialog box is displayed after <Print Screen> is pressed) and you press the key sequences before that time has elapsed, the OSCAR interface does not display.

To configure OSCAR for soft switching:

- 1 Press <Print Screen> to launch the OSCAR interface. The **Main** dialog box appears.
- 2 Click **Setup** and then **Menu**. The **Menu** dialog box appears.
- 3 Select **Name** or **Slot** for the Display/Sort Key.
- 4 Type the desired delay time in seconds in the **Screen Delay Time** field.
- 5 Click **OK**.

To soft switch to a server:

- To select a server, press <Print Screen>.

If the display order of your server list is by slot as per your selection in step 3 (that is, the **Slot** button is depressed), type the slot number and press <Enter>.

or

If the display order of your server list is by name as per your selection in step 3 (that is, the **Name** button is depressed), type the first few characters of the name of the server to establish it as unique and press <Enter>.

- To switch back to the previous server, press <Print Screen> then <Backspace>.

## Video Connections

The iKVM has video connections on the front and rear panels of the chassis. The front panel connection signals take precedence over that of the rear panel. When a monitor is connected to the front panel, the video connection does not pass through to the rear panel, and an OSCAR message displays stating that the rear panel KVM and ACI connections are disabled. If the monitor is disabled (that is, removed from the front panel or disabled by a CMC command), the ACI connection becomes active while the rear panel KVM remains disabled. (For information about order of connection precedence, see "iKVM Connection Precedences" on page 226.)

For information about enabling or disabling the front panel connection, see "Enabling or Disabling the Front Panel" on page 243.

## Preemption Warning

Normally, a user connected to a server console through the iKVM and another user connected to the same server console through the iDRAC GUI console redirection feature both have access to the console and are able to type simultaneously.

To prevent this scenario, the remote user, before starting the iDRAC GUI console redirection, can disable the local console in the iDRAC Web interface. The local iKVM user sees an OSCAR message that the connection will be preempted in a specified amount of time. The local user should finish work before the iKVM connection to the server is terminated.

There is no preemption feature available to the iKVM user.



**NOTE:** If a remote iDRAC user has disabled the local video for a specific server, that server's video, keyboard and mouse will be unavailable to the iKVM. The server state is marked with a yellow dot in the OSCAR menu to indicate that it is locked or unavailable for local use (see "Viewing the Status of Your Servers" on page 233).

## Setting Console Security

OSCAR enables you to configure security settings on your iKVM console. You can establish a screen saver mode that engages after your console remains unused for a specified delay time. Once engaged, your console remains locked until you press any key or move the mouse. Enter the screen saver password to continue.

Use the **Security** dialog box to lock your console with password protection, set or change your password, or enable the screen saver.

 **NOTE:** If the iKVM password is lost or forgotten, you can reset it to the iKVM factory default using the CMC Web interface or RACADM. See "Clearing a Lost or Forgotten Password" on page 238.

### Accessing the Security Dialog Box

- 1 Press <Print Screen>. The **Main** dialog box appears.
- 2 Click **Setup** and the **Security**. The **Security** dialog box appears.

### Setting or Changing the Password

- 1 Single-click and press <Enter> or double-click in the **New** field.
- 2 Type the new password in the **New** field and then press <Enter>. Passwords are case sensitive and require 5–12 characters. They must include at least one letter and one number. Legal characters are: A–Z, a–z, 0–9, space, and hyphen.
- 3 In the **Repeat** field, type the password again, and then press <Enter>.
- 4 Click **OK** if you only want to change your password, and then close the dialog box.

### Password-protecting Your Console

- 1 Set your password as described in the previous procedure.
- 2 Select the **Enable Screen Saver** box.
- 3 Type the number of minutes of **Inactivity Time** (from 1 through 99) to delay password protection and screen saver activation.
- 4 For **Mode**: If your monitor is ENERGY STAR® compliant, select **Energy**; otherwise select **Screen**.

 **NOTE:** If the mode is set to **Energy**, the appliance will put the monitor into sleep mode. This is normally indicated by the monitor powering off and the amber light replacing the green power LED. If the mode is set to **Screen**, the OSCAR flag will bounce around the screen for the duration of the test. Before the test starts, a warning popup box displays the following message: "Energy mode may damage a monitor that is not ENERGY STAR compliant. However, once started, the test can be quit immediately via mouse or keyboard interaction."



**CAUTION: Monitor damage may result from the use of Energy mode with monitors not compliant with Energy Star.**

- 5 Optional: To activate the screen saver test, click **Test**. The **Screen Saver Test** dialog box displays. Click **OK** to start the test.

The test takes 10 seconds. When it concludes, you are returned to the **Security** dialog box.

### **Logging In**

- 1 Press <Print Screen> to launch OSCAR. The **Password** dialog box appears.
- 2 Type your password and then click **OK**. The **Main** dialog box appears.

### **Setting Automatic Logout**

You can set OSCAR to automatically log out of a server after a period of inactivity.

- 1 In the **Main** dialog box, click **Setup** and then **Security**.
- 2 In the **Inactivity Time** field, enter the length of time you want to stay connected to a server before it automatically disconnects you.
- 3 Click **OK**.

### **Removing Password Protection From Your Console**

- 1 From the **Main** dialog box, click **Setup** and then **Security**.
- 2 In the **Security** dialog box, single-click and press <Enter>, or double-click in the **New** field.
- 3 Leaving the **New** field empty, press <Enter>.
- 4 Single-click and press <Enter>, or double-click in the **Repeat** field.
- 5 Leaving the **Repeat** field empty, press <Enter>.
- 6 Click **OK** if you only want to eliminate your password.

## Enabling Screen Saver Mode With No Password Protection



**NOTE:** If your console is password protected, you must first remove password protection. Follow the steps in the previous procedure before following the steps below.

- 1 Select **Enable Screen Saver**.
- 2 Type the number of minutes (1 through 99) that you want to delay activation of the screen saver.
- 3 Select **Energy** if your monitor is ENERGY STAR compliant; otherwise select **Screen**.



**CAUTION: Monitor damage may result from the use of Energy mode with monitors not compliant with Energy Star.**

- 4 Optional: To activate the screen saver test, click **Test**. The **Screen Saver Test** dialog box displays. Click **OK** to start the test.

The test takes 10 seconds. When it concludes, you are returned to the **Security** dialog box.



**NOTE:** Enabling screen saver mode disconnects the user from a server; no server is selected. The status flag displays **Free**.

## Exiting Screen Saver Mode

To exit screen saver mode and return to the **Main** dialog box, press any key or move your mouse.

To turn off the screen saver:

- 1 In the **Security** dialog box, clear the **Enable Screen Saver** box.
- 2 Click **OK**.

To immediately turn on the screen saver, press <Print Screen>, then press <Pause>.

## Clearing a Lost or Forgotten Password

When the iKVM password is lost or forgotten, you can reset it to the iKVM factory default, and then change the password. You can reset the password using either the CMC Web interface or RACADM.

To reset a lost or forgotten iKVM password using the CMC Web interface:

- 1 Log in to the CMC Web interface.
- 2 Select **iKVM** from the Chassis submenu.
- 3 Click the **Setup** tab. The **iKVM Configuration** page displays.
- 4 Click **Restore Default Values**.

You can then change the password from the default using OSCAR. See "Setting or Changing the Password" on page 236.

To reset a lost or forgotten password using RACADM, open a Telnet/SSH text console to the CMC, log in, and type:

```
racadm racresetcfg -m kvm
```



**NOTE:** Using the **racresetcfg** command resets the Front Panel Enable and Dell CMC Console Enable settings, if they are different from the default values.

For more information about the **racresetcfg** subcommand, see "racresetcfg" on page 330.

### Changing the Language

Use the **Language** dialog box to change the OSCAR text to display in any of the supported languages. The text immediately changes to the selected language on all of the OSCAR screens.

To change the OSCAR language:

- 1 Press <Print Screen>. The **Main** dialog box appears.
- 2 Click **Setup** and then **Language**. The **Language** dialog box appears.
- 3 Click the radio button for the desired language, and then click **OK**.

### Displaying Version Information

Use the **Version** dialog box to display the iKVM firmware and hardware versions, and to identify the language and keyboard configuration.

To display version information:

- 1 Press <Print Screen>. The **Main** dialog box appears.
- 2 Click **Commands** and then **Display Versions**. The **Version** dialog box appears.  
The top half of the **Version** dialog box lists the subsystem versions in the appliance.
- 3 Click  or press <Esc> to close the **Version** dialog box.

## Scanning Your System

In scan mode, the iKVM automatically scans from slot to slot (server to server). You can scan up to 16 servers by specifying which servers you want to scan and the number of seconds that each server is displayed.

To add servers to the scan list:

- 1 Press <Print Screen>. The **Main** dialog box appears.
- 2 Click **Setup** and then **Scan**. The **Scan** dialog box appears, listing of all servers in the chassis.
- 3 Select the box next to the servers you wish to scan.  
or  
Double-click the server name or slot.  
or  
Press <Alt > and the number of the server you wish to scan. You can select up to 16 servers.
- 4 In the **Time** field, enter the number of seconds (3 through 99) that you want iKVM to wait before the scan moves to the next server in the sequence.
- 5 Click the **Add/Remove** button, and then click **OK**.

To remove a server from the **Scan** list:

- 1 In the **Scan** dialog box, select the box next to the server to be removed.  
or  
Double-click the server name or slot.



or

Click the **Clear** button to remove all servers from the **Scan** list.

- 2 Click the **Add/Remove** button, and then click **OK**.

To start Scan mode:

- 1 Press <Print Screen>. The **Main** dialog box appears.
- 2 Click **Commands**. The **Command** dialog box appears.
- 3 Select the **Scan Enable** box.
- 4 Click **OK**. A message appears indicating that the mouse and keyboard have been reset.
- 5 Click  to close the message box.

To cancel scan mode:

- 1 If OSCAR is open and the **Main** dialog box is displayed, select a server in the list.

or

If OSCAR is *not* open, move the mouse or press any key on the keyboard. Scanning stops at the currently selected server.

or

Press <Print Screen>. The **Main** dialog box appears; select a server in the list.

- 2 Click the **Commands** button. The **Commands** dialog box appears.
- 3 Clear the **Scan Enable** box.

## Broadcasting to Servers

You can simultaneously control more than one server in the system to ensure that all selected servers receive identical input. You can choose to broadcast keystrokes and/or mouse movements independently.



**NOTE:** You can broadcast up to 16 servers at a time.

To broadcast to servers:

- 1 Press <Print Screen>. The **Main** dialog box appears.
- 2 Click **Setup** and then **Broadcast**. The **Broadcast** dialog box appears.



**NOTE:** Broadcasting keystrokes: When using keystrokes, the keyboard state must be identical for all servers receiving a broadcast for the keystrokes to be interpreted identically. Specifically, the <Caps Lock> and <Num Lock> modes must be the same on all keyboards. While the iKVM attempts to send keystrokes to the selected servers simultaneously, some servers may inhibit and thereby delay the transmission.



**NOTE:** Broadcasting mouse movements: For the mouse to work accurately, all servers must have identical mouse drivers, desktops (such as identically placed icons), and video resolutions. The mouse also must be in exactly the same place on all screens. Because these conditions are extremely difficult to achieve, broadcasting mouse movements to multiple servers may have unpredictable results.

- 3 Enable mouse and/or keyboard for the servers that are to receive the broadcast commands by selecting the boxes.

or

Press the up or down arrow keys to move the cursor to a target server. Then press <Alt><K> to select the keyboard box and/or <Alt><M> to select the mouse box. Repeat for additional servers.

- 4 Click **OK** to save the settings and return to the **Setup** dialog box. Click  or press <Escape> to return to the **Main** dialog box.
- 5 Click **Commands**. The **Commands** dialog box appears.
- 6 Click the **Broadcast Enable** box to activate broadcasting. The **Broadcast Warning** dialog box appears.
- 7 Click **OK** to enable the broadcast.

To cancel and return to the **Commands** dialog box, click  or press <Esc>.

- 8 If broadcasting is enabled, type the information and/or perform the mouse movements you want to broadcast from the management station. Only servers in the list are accessible.

To turn broadcasting off:

From the **Commands** dialog box, clear the **Broadcast Enable** box.

# Managing iKVM From the CMC

## Enabling or Disabling the Front Panel

To enable or disable access to the iKVM from the front panel using RACADM, open a Telnet/SSH text console to the CMC, log in, and type:

```
racadm config -g cfgKVMInfo -o cfgKVMFrontPanelEnable <value>
```

where *<value>* is 1 (enable) or 0 (disable).

For more information about the **config** subcommand, see "config" on page 290.

To enable or disable access to the iKVM from the front panel using the Web interface:

- 1 Log in to the CMC Web interface.
- 2 Select iKVM in the system tree. The **iKVM Status** page displays.
- 3 Click the **Setup** tab. The **iKVM Configuration** page displays.
- 4 To enable, select the **Front Panel USB/Video Enabled** check box.  
To disable, clear the **Front Panel USB/Video Enabled** check box.
- 5 Click **Apply** to save the setting.

## Enabling the Dell CMC Console via iKVM

To enable the iKVM to access the Dell CMC console using RACADM, open a Telnet/SSH text console to the CMC, log in, and type:

```
racadm config -g cfgKVMInfo -o  
cfgKVMAccessToCMCEnable 1
```

To enable the Dell CMC console using the Web interface:

- 1 Log in to the CMC Web interface.
- 2 Select iKVM in the system tree. The **iKVM Status** page displays.
- 3 Click the **Setup** tab. The **iKVM Configuration** page displays.
- 4 Select the **Allow access to CMC CLI from iKVM** check box.
- 5 Click **Apply** to save the setting.

## Viewing the iKVM Status and Properties

The local access KVM module for your Dell M1000e server chassis is called the Avocent® Integrated KVM Switch Module, or iKVM.

For more information about iKVM, see "Using the iKVM Module" on page 225.

To view the status of the iKVM:

- 1 Log in to the CMC Web interface.
- 2 Select **iKVM** in the system tree.
- 3 Click the **Properties** tab.
- 4 Click the **Status** sub-tab. The **iKVM Status** page displays.

Table 9-5 provides descriptions of the information provided on the **iKVM Status** page.

**Table 9-5. iKVM Status Information**

<b>Item</b>	<b>Description</b>
Presence	Indicates whether the iKVM module is <b>Present</b> or <b>Absent</b> .
Power State	Indicates the power status of the iKVM: <b>On</b> , <b>Off</b> , or <b>N/A</b> (Absent).
Name	Displays the product name of the iKVM.
Service Tag	Displays the service tag of the iKVM. The service tag is a unique identifier provided by the manufacturer for support and maintenance.
Manufacturer	Displays in the manufacturer of the iKVM.
Part Number	Displays the part number for the iKVM. The part number is a unique identifier provided by the vendor.
Firmware Version	Indicates the firmware version of the iKVM.
Hardware Version	Indicates the hardware version of the iKVM.
Front Panel Connected	Indicates whether the monitor is <b>connected</b> to the front panel VGA connector ( <b>Yes</b> or <b>No</b> ). This information is provided to the CMC so it can determine whether a local user has front-panel access to the chassis.

**Table 9-5. iKVM Status Information (continued)**

Item	Description
Rear Panel Connected	Indicates whether the monitor is <b>connected</b> to the rear panel VGA connector ( <b>Yes</b> or <b>No</b> ). This information is provided to the CMC so it can determine whether a local user has rear-panel access to the chassis.
Tiering Port Connected	The iKVM supports seamless tiering with external KVM appliances from Dell and Avocent using built-in hardware. When the iKVM is tiered, the servers in the chassis can be accessed through the screen display of the external KVM switch from which the iKVM is tiered.
Front Panel USB/Video Enabled	Displays whether the front panel VGA connector is enabled ( <b>Yes</b> or <b>No</b> ).
Allow access to CMC from iKVM	Indicates whether the CMC command console through iKVM is enabled ( <b>Yes</b> or <b>No</b> ).

## Updating the iKVM Firmware

You can update the iKVM firmware using the CMC Web interface or RACADM.

To update the iKVM firmware using the CMC Web interface:

- 1 Log in to the CMC Web interface.
- 2 Click **Chassis** in the system tree.
- 3 Click the **Update** tab. The **Updatable Components** page displays.
- 4 Click **iKVM**. The **Firmware Update** page displays.
- 5 In the **Value** field, type the path on your management station or shared network where the firmware image file resides, or click **Browse** to navigate to the file location.  
 **NOTE:** The default iKVM firmware image name is **ikvm.bin**; however, you can rename the iKVM firmware image.
- 6 Click **Update**. A dialog box appears asking you to confirm the action.
- 7 Click **Yes** to continue.

-  **NOTE:** The update may take up to a minute.

When the update is complete, iKVM resets.

To update the iKVM firmware using RACADM, open a Telnet/SSH text console to the CMC, log in, and type:

```
racadm fwupdate -g -u -a <TFTP server IP address> -d  
<filepath/filename> -m kvm
```

For example:

```
racadm fwupdate -gua 192.168.0.10 -d ikvm.bin -m kvm
```

For more information about the **fwupdate** subcommand, see "fwupdate" on page 296.

## Troubleshooting



**NOTE:** If you have an active console redirection session and a lower resolution monitor is connected to the iKVM, the server console resolution may reset if the server is selected on the local console. If the server is running a Linux operating system, an X11 console may not be viewable on the local monitor. Pressing <Ctrl><Alt><F1> at the iKVM will switch Linux to a text console.

**Table 9-6. Troubleshooting iKVM**

<b>Problem</b>	<b>Likely Cause and Solution</b>
The message "User has been disabled by CMC control" appears on the monitor connected to the front panel.	<p>The front panel connection has been disabled by the CMC.</p> <p>You can enable the front panel using either the CMC Web interface or RACADM.</p> <p>To enable the front panel using the Web interface:</p> <ol style="list-style-type: none"><li>1 Log in to the CMC Web interface.</li><li>2 Select iKVM in the system tree.</li><li>3 Click the <b>Setup</b> tab.</li><li>4 Select the <b>Front Panel USB/Video Enabled</b> check box.</li><li>5 Click <b>Apply</b> to save the setting.</li></ol> <p>To enable the front panel using RACADM, open a Telnet/SSH text console to the CMC, log in, and type:</p> <pre>racadm config -g cfgKVMInfo -o cfgKVMAccessToCMCEnable 1.</pre>
The rear panel access does not work.	<p>The front panel setting is enabled by the CMC, and a monitor is currently connected to the front panel.</p> <p>Only one connection is allowed at a time. The front panel connection has precedence over ACI and the rear panel. For more information about connection precedence, see "iKVM Connection Precedences" on page 226.</p>

**Table 9-6. Troubleshooting iKVM (continued)**

<b>Problem</b>	<b>Likely Cause and Solution</b>
The message "User has been disabled as another appliance is currently tiered" appears on the monitor connected to the rear panel.	<p>A network cable is connected to the iKVM ACI port connector and to a secondary KVM appliance.</p> <p>Only one connection is allowed at a time. The ACI tiering connection has precedence over the rear panel monitor connection. The precedence order is front panel, ACI, and then rear panel.</p>
The iKVM's amber LED is blinking.	<p>There are three possible causes:</p> <p><b>There is problem with the iKVM</b>, for which the iKVM requires reprogramming. To fix the problem, follow the instructions for updating iKVM firmware (see "Updating the iKVM Firmware" on page 245).</p> <p><b>The iKVM is reprogramming the CMC Console Interface.</b> In this case, the CMC Console is temporarily unavailable and represented by a yellow dot in the OSCAR interface. This process takes up to 15 minutes.</p> <p><b>The iKVM firmware has detected a hardware error.</b> For additional information, view the iKVM status.</p> <p>To view iKVM status using the Web interface:</p> <ol style="list-style-type: none"><li>1 Log in to the CMC Web interface.</li><li>2 Select iKVM in the system tree, and then click <b>Properties</b>.</li></ol> <p>To view iKVM status using RACADM, open a Telnet/SSH text console to the CMC, log in, and type:</p> <pre>racadm getkvminfo</pre>



**Table 9-6. Troubleshooting iKVM (continued)**

<b>Problem</b>	<b>Likely Cause and Solution</b>
<p>My iKVM is tiered through the ACI port to an external KVM switch, but all of the entries for the ACI connections are unavailable.</p> <p>All of the states are showing a yellow dot in the OSCAR interface.</p>	<p>The front panel connection is enabled and has a monitor connected. Because the front panel has precedence over all other iKVM connections, the ACI and rear panel connectors are disabled.</p> <p>To enable your ACI port connection, you must first disable front panel access or remove the monitor connected to the front panel. The external KVM switch OSCAR entries will become active and accessible.</p> <p>To disable the front panel using the Web interface:</p> <ol style="list-style-type: none"><li>1 Log in to the CMC Web interface.</li><li>2 Select iKVM in the system tree.</li><li>3 Click the <b>Setup</b> tab.</li><li>4 Clear (un-check) the <b>Front Panel USB/Video Enabled</b> check box.</li><li>5 Click <b>Apply</b> to save the setting.</li></ol> <p>To disable the front panel using RACADM, open a Telnet/SSH text console to the CMC, log in, and type:</p> <pre>racadm config -g cfgKVMInfo - o cfgKVMFrontPanelEnable 0</pre>

**Table 9-6. Troubleshooting iKVM (continued)**

Problem	Likely Cause and Solution
In the OSCAR menu, the Dell CMC connection is displaying a red X, and I cannot connect to the CMC.	<p>There are two possible causes:</p> <p><b>The Dell CMC console has been disabled.</b> In this case, you can enable it using either the CMC Web interface or RACADM.</p> <p>To enable the Dell CMC console using the Web interface:</p> <ol style="list-style-type: none"><li>1 Log in to the CMC Web interface.</li><li>2 Select <b>iKVM</b> in the system tree.</li><li>3 Click the <b>Setup</b> tab.</li><li>4 Select the <b>Allow access to CMC CLI from iKVM</b> check box.</li><li>5 Click <b>Apply</b> to save the setting.</li></ol>
The slot name for a server is displayed as "Initializing" in OSCAR, and I cannot select it.	<p>To enable the Dell CMC connection using RACADM, open a Telnet/SSH text console to the CMC, log in, and type:</p> <pre>racadm config -g cfgKVMInfo -o cfgKVMAccessToCMCEnable 1</pre> <p><b>The CMC is unavailable because it is initializing, switching over to the standby CMC, or reprogramming.</b> In this case, simply wait until the CMC finishes initializing.</p> <p>Either the server is initializing or the iDRAC on that server failed initialization.</p> <p>First, wait 60 seconds. If the server is still initializing, the slot name will appear as soon as initialization is complete, and you can select the server.</p> <p>If, after 60 seconds, OSCAR still indicates that the slot is initializing, remove and then re-insert the server in the chassis. This action will allow iDRAC to re-initialize.</p>

# I/O Fabric Management

The chassis can hold up to six I/O modules (IOMs), each of which can be pass-through or switch modules.

The IOMs are classified into three groups: A, B, and C. Each group has two slots: Slot 1 and Slot 2. The slots are designated with letters, from left to right, across the back of the chassis: A1 | B1 | C1 | C2 | B2 | A2. Each server has slots for two mezzanine cards (MCs) to connect to the IOMs. The MC and the corresponding IOM must have the same fabric.

The chassis supports three fabric or protocol types. The IOMs in a group must have the same or compatible fabric types.

- **Group A** is always connected to the servers' on-board Ethernet adapters; the fabric type of Group A will always be Ethernet.
- **Group B** connects to the first MC on each server.
- **Group C** connects to the second MC on each server.

In addition, each MC can support two external links. For example, in the first MC, the first link is permanently connected to slot 1 of Group B, and the second link is permanently connected to slot 2 of Group B.



**NOTE:** In the CMC CLI, IOMs are referred to by the convention `switchn`: A1=switch1, A2=switch2, B1=switch3, B2=switch4, C1=switch5, and C2=switch6.

## Fabric Management

Fabric management helps you avoid and take care of any electrical-, configuration-, or connectivity-related problems due to installation of an IOM that has a different fabric from the server or its MCs. Invalid hardware configurations could cause electric or functional problems to the chassis or its components. However, not all valid configurations are necessarily supported configurations. Fabric management will only prevent invalid configurations from powering on.

Figure 10-1 shows the location of IOMs in the chassis. The location of each IOM in the chassis is indicated by its group number (A, B, or C) and slot number (1 or 2). On the chassis, the IOM slot names are marked A1, A2, B1, B2, C1, or C2.

**Figure 10-1. Rear View of a Chassis, Showing the Location of the IOMs**

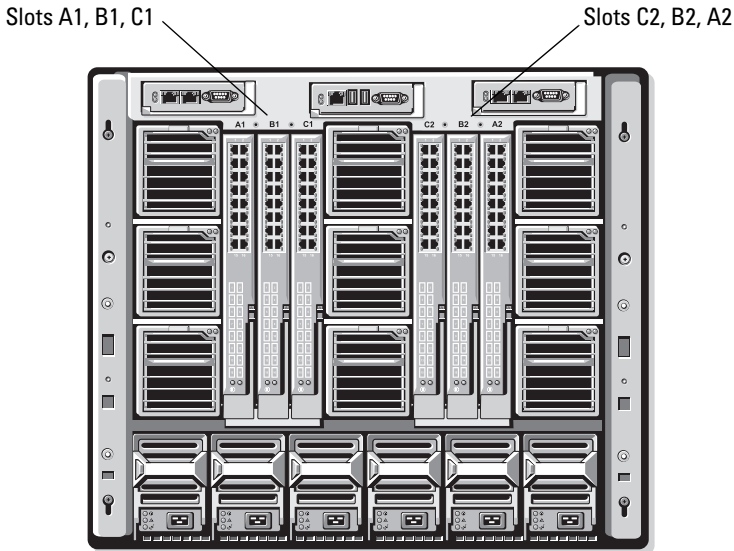

The CMC creates entries in both the hardware log and CMC logs for invalid hardware configurations.

For example:

- An Ethernet MC connected to a Fibre Channel IOM is an invalid configuration. However, an Ethernet switch and a pass-through IOM installed to the same IOM group is a valid configuration.
- A Fibre Channel pass-through IOM and a fibre channel switch IOM in slots B1 and B2 is a valid configuration if the first MCs on all of the servers are also fibre channel. In this case, the CMC will power-on the IOMs and the servers. However, certain fibre channel redundancy software may not support this configuration.



**NOTE:** Fabric verification for server MCs is performed only when the chassis is powered on. When the chassis is on standby power, the iDRACs on the server modules remain powered off and thus are unable to report the server's MC fabric type. The MC fabric type may not be reported in the CMC user interface until the iDRAC on the server is powered on.

## Invalid Configurations

There are three types of invalid configurations:

- Invalid MC configuration, where a newly installed MC fabric is different from the existing IOM fabric
- Invalid IOM-MC configuration, where the newly installed IOM and MC fabric does not match or is incompatible
- Invalid IOM-IOM configuration, where a newly installed IOM has a different or incompatible fabric type from an IOM already installed in its group

### Invalid MC Configuration

An invalid MC configuration occurs when a single server's MC is not supported by its corresponding IOM. In this case, all the other servers in the chassis can be running.

### Invalid IOM-MC Configuration

The mismatched IOM will be held in the power-off state. The CMC adds an entry to the CMC and hardware logs noting the invalid configuration and specifying the IOM name. The CMC will also cause the error LED on the offending IOM to blink. If the CMC is configured to send alerts, it sends e-mail and/or SNMP alerts for this event.

For information about the CMC and hardware logs, see "Viewing the Event Logs" on page 273.

### Invalid IOM-IOM Configuration

The CMC holds a newly installed IOM in powered-off state, causes the IOM's error LED to blink, and creates entries in the CMC and hardware logs about the mismatch.

For information about the CMC and hardware logs, see "Viewing the Event Logs" on page 273.

## Fresh Power-up Scenario

When the chassis is plugged in and powered up, the I/O modules have priority over the servers. The first IOM in each group is allowed to power up before the others. At this time, no verification of their fabric types is performed. If there is no IOM on the first slot of a group, the module on the second slot of that group powers up. If both slots have IOMs, the module in the second slot is compared for consistency against the one in the first.

After the IOMs power up, the servers power up, and the CMC verifies the servers for fabric consistency.

A pass-through module and switch are allowed in the same group as long as their fabric is identical. Switches and pass-through modules can exist in the same group even if they were manufactured by different vendors.





## Monitoring IOM Health

To view the health status of all IOMs:

- 1 Log in to the CMC Web interface.
- 2 Select **I/O Modules** in the **Chassis** menu in the system tree.
- 3 Click the **Properties** tab.
- 4 Click the **Status** sub-tab. The **I/O Modules Status** page displays.

Table 10-1 provides descriptions of the information provided on the **I/O Modules Status** page.

**Table 10-1. I/O Modules Health Status Information**

Item	Description
Present	Indicates whether the IOM is <b>Present</b> or <b>Absent</b> .
Health	 <b>OK</b> Indicates that the IOM is present and communicating with the CMC. In the event of a communication failure between the CMC and the server, the CMC cannot obtain or display health status for the IOM.
	 <b>Informational</b> Displays information about the IOM when no change in health status (OK, Warning, Severe) has occurred.
	 <b>Warning</b> Indicates that only warning alerts have been issued, and <b>corrective action must be taken within the time frame set by the administrator</b> . If corrective actions are not taken within the administrator-specified time, it could lead to critical or severe failures that can affect the integrity of the IOM.
	<p>Examples of conditions causing Warnings: IOM fabric mismatch with the server's mezzanine card fabric; invalid IOM configuration, where the newly installed IOMs do not match the existing IOM on the same group.</p>
	 <b>Severe</b> Indicates at least one Failure alert has been issued. Severe status represents a system failure on the IOM, and <b>corrective action must be taken immediately</b> .
	<p>Examples of conditions causing Severe status: Failure in IOM detected; IOM was removed.</p>
	<p><b>NOTE:</b> Any change in health is logged to both the hardware and CMC log. For more information, see "Viewing the Event Logs" on page 273.</p>
Slot	Indicates the location of the IOM in the chassis by group number (A, B, or C) and slot number (1 or 2). Slot names: <b>A1, A2, B1, B2, C1,C2</b> .
Name	Displays the IOM product name.

**Table 10-1. I/O Modules Health Status Information (continued)**

<b>Item</b>	<b>Description</b>
Power Status	Indicates the power status of the IOM: <b>On</b> , <b>Off</b> , or <b>N/A (Absent)</b> .
Service Tag	Displays the service tag for the IOM. The service tag a unique identifier provided by Dell for support and maintenance.  Any change in health is logged to both the hardware and CMC log. For more information, see "Viewing the Event Logs" on page 273.  <b>NOTE:</b> Passthroughs do not have service tags. Only switches have service tags.

### **Viewing the Health Status of an Individual IOM**

The **I/O Module Status** page (separate from the *I/O Modules Status* page) provides an overview of an individual IOM.

To view the health status of an individual IOM:

- 1** Log in to the CMC Web interface.
- 2** Expand **I/O Modules** in the system tree. All of the IOMs (1–6) appear in the expanded **I/O Modules** list.
- 3** Click the IOM you want to view in the **I/O Modules** list in the system tree.
- 4** Click the **Status** sub-tab. The **I/O Modules Status** page displays.





Table 10-2 provides descriptions of the information provided on the **I/O Module Status** page.

**Table 10-2. I/O Module Health Status Information**

<b>Item</b>	<b>Description</b>
Name	Displays name of the IOM.
Present	Indicates whether the IOM is <b>Present</b> or <b>Absent</b> .



**Table 10-2. I/O Module Health Status Information (continued)**

Item	Description
Health	<p data-bbox="329 292 370 323"> OK</p> <p data-bbox="535 284 999 427">Indicates that the IOM is present and communicating with the CMC. In the event of a communication failure between the CMC and the server, the CMC cannot obtain or display health status for the IOM.</p> <p data-bbox="329 443 370 483"> Informational</p> <p data-bbox="385 443 999 531">Displays information about the IOM when no change in health status (OK, Warning, Severe) has occurred.</p> <p data-bbox="535 547 999 627">Examples of conditions causing Informational status: the IOM presence was detected; a user requested IOM power cycle.</p> <p data-bbox="329 643 370 683"> Warning</p> <p data-bbox="385 643 999 850">Indicates that only warning alerts have been issued, and <b>corrective action must be taken within the time frame set by the administrator</b>. If corrective actions are not taken within the administrator-specified time, it could lead to critical or severe failures that can affect the integrity of the IOM.</p> <p data-bbox="535 866 999 1034">Examples of conditions causing Warnings: IOM fabric mismatch with the server's mezzanine card fabric; invalid IOM configuration, where the newly installed IOMs do not match the existing IOM on the same group.</p> <p data-bbox="329 1050 370 1090"> Severe</p> <p data-bbox="535 1050 999 1169">Indicates at least one Failure alert has been issued. Severe status represents a system failure on the IOM, and <b>corrective action must be taken immediately</b>.</p> <p data-bbox="535 1185 999 1232">Examples of conditions causing Severe status: Failure in IOM detected; IOM was removed.</p>

**NOTE:** Any change in health is logged to both the hardware and CMC log. For information on viewing logs, see "Viewing the Hardware Log" on page 273 and "Viewing the CMC Log" on page 275.

**Table 10-2. I/O Module Health Status Information (continued)**

<b>Item</b>	<b>Description</b>
Location	Indicates the location of the IOM in the chassis by group number (A, B, or C) and slot number (1 or 2). Slot names: <b>A1, A2, B1, B2, C1, or C2</b> .
Power Status	Indicates the power status of the IOM: <b>On, Off, or N/A (Absent)</b> .
Service Tag	Displays the service tag for the IOM. The service tag a unique identifier provided by Dell for support and maintenance.
Fabric	Indicates the type of fabric for the IOM: Gigabit Ethernet, 10GE XAUI, 10GE KR, 10GE XAUI KR, FC 4 Gbps, FC 8 Gbps, SAS 3 Gbps, SAS 6 Gbps, Infiniband SDR, Infiniband DDR, Infiniband QDR, PCIe Bypass Generation 1, PCIe Bypass Generation 2. <b>NOTE:</b> Knowing the fabric types of the IOMs in your chassis is critical in preventing IOM mismatches within the same group. For information about I/O fabric, see "I/O Fabric Management" on page 251.
MAC Address	Displays the MAC address for the IOM. The MAC address is a unique address assigned to a device by the hardware vendor as a means for identification. <b>NOTE:</b> Passthroughs do not have MAC addresses. Only switches have MAC addresses.

# Troubleshooting and Recovery

## Overview

This section explains how to perform tasks related to recovering and troubleshooting a problems on the remote system using the CMC Web interface.

- Managing power on a remote system
- Viewing chassis information
- Viewing the event logs
- Using the Diagnostic Console
- Troubleshooting network problems
- Troubleshooting alerting problems

## Chassis Monitoring Tools

### Configuring LEDs to Identify Components on the Chassis

You can set component LEDs for all or individual components (chassis, servers, and IOMs) to blink as a means of identifying the component on the chassis.



**NOTE:** To modify these settings, you must have **Chassis Configuration Administrator** privilege.

### Using the Web Interface

To enable blinking for one, multiple, or all component LEDs:

- 1 Log in to the CMC Web interface.
- 2 Click **Chassis** in the system tree.
- 3 Click the **Troubleshooting** tab.
- 4 Click the **Identify** sub-tab. The **Identify** page displays, featuring a list of all components on the chassis.

- 5 Select the component or components for which you want to enable LED blinking.
- 6 Click **Apply**.

### Using RACADM

Open a Telnet/SSH text console to the CMC, log in, and type:

```
racadm settled -m <module> [-1 <ledState>]
```

where *<module>* specifies the module whose LED you want to configure.

Configuration options:

- `server-n` where  $n=1-16$
- `switch-n` where  $n=1-6$
- `cmc-active`

and *<ledState>* specifies whether the LED should blink.

Configuration options:

- 0 — no blinking (default)
- 1 — blinking

### Configuring SNMP Alerts

Simple network management protocol (SNMP) traps, or *event traps*, are similar to e-mail event alerts. They are used by a management station to receive unsolicited data from the CMC.

You can configure the CMC to generate event traps. Table 11-1 provides an overview of the events that trigger SNMP and e-mail alerts. For information on e-mail alerts, see "Configuring E-mail Alerts" on page 265.

**Table 11-1. Chassis Events That Can Generate SNMP and E-mail Alerts**

Event	Description
Fan Probe Failure	A fan is running too slow or not at all.
Battery Probe Warning	A battery has stopped functioning.
Temperature Probe Warning	The temperature is approaching excessively high or low limits.

**Table 11-1. Chassis Events That Can Generate SNMP and E-mail Alerts (continued)**

<b>Event</b>	<b>Description</b>
Temperature Probe Failure	The temperature is either too high or too low for proper operation.
Redundancy Degraded	Redundancy for the fans and/or power supplies has been reduced.
Redundancy Lost	No redundancy remains for the fans and/or power supplies.
Power Supply Warning	The power supply is approaching a failure condition.
Power Supply Failure	The power supply has failed.
Power Supply Absent	An expected power supply is not present.
Hardware Log Failure	The hardware log is not functioning.
Hardware Log Warning	The hardware log is almost full.
Server Absent	An expected server is not present.
Server Failure	The server is not functioning.
KVM Absent	An expected KVM is not present.
KVM Failure	The KVM is not functioning.
IOM Absent	An expected IOM is not present.
IOM Failure	The IOM is not functioning.

You can add and configure SNMP alerts using the Web interface or RACADM.

### Using the Web Interface



**NOTE:** To add or configure SNMP alerts, you must have **Chassis Configuration Administrator** and **Network Administrator** privileges.



**NOTE:** For added security, Dell strongly recommends that you change the default password of the root (User 1) account. The root account is the default administrative account that ships with the CMC. To change the default password for the root account, click User ID 1 to open the **User Configuration** page. Help for that page is available through the **Help** link at the top right corner of the page.

- 1 Log in to the CMC Web interface.
- 2 Select **Chassis** in the system tree.

- 3 Click the **Alert Management** tab. The **Chassis Events** page appears.
- 4 Enable alerting:
  - a Select the check boxes of the events for which you want to enable alerting. To enable all events for alerting, select the **Select All** check box.
  - b Click **Apply** to save your settings.
- 5 Click the **Traps Settings** sub-tab. The **Chassis Event Alert Destinations** page displays.
- 6 Type a valid IP address in an empty **Destination IP Address** field.
- 7 Type the **SNMP Community String** to which the destination management station belongs.



**NOTE:** The community string on the **Chassis Event Alert Destinations** page differs from the community string on the **Chassis**→ **Network/Security**→ **Services** page. The SNMP traps community string is the community that the CMC uses for outbound traps destined to management stations. The community string on the **Chassis**→ **Network/Security**→ **Services** page is the community string that management stations use to query the SNMP daemon on the CMC.

- 8 Click **Apply** to save your changes.

To test an event trap for an alert destination:

- 1 Log in to the CMC Web interface.
- 2 Select **Chassis** in the system tree.
- 3 Click the **Alert Management** tab. The **Chassis Events** page appears.
- 4 Click the **Traps Settings** tab. The **Chassis Event Alert Destinations** page displays.
- 5 Click **Send** in the **Test Trap** column beside the destination.

### Using RACADM

- 1 Open a Telnet/SSH text console to the CMC and log in.



**NOTE:** Only one filter mask may be set both SNMP and e-mail alerting. You may skip step 2 if you have already selected filter mask.

- 2 Enable alerting by typing:

```
racadm config -g cfgAlerting -o cfgAlertingEnable 1
```

- 3 Specify the events for which you want the CMC to generate by typing:

```
racadm config -g cfgAlerting -o  
cfgAlertingFilterMask <mask value>
```

where *<mask value>* is a hex value between 0x0 and 0x003ffff.

To obtain the mask value, use a scientific calculator in hex mode and add the second values of the individual masks (1, 2, 4, etc.) using the *<OR>* key.

For example, to enable trap alerts for Battery Probe Warning (0x2), Power Supply Failure (0x1000), and KVM failure (0x80000), key 2 *<OR>* 1000 *<OR>* 200000 and press the *<=>* key.

The resulting hex value is 208002, and the mask value for the RACADM command is 0x208002.

**Table 11-2. Event Traps Filter Masks**

<b>Event</b>	<b>Filter Mask Value</b>
Fan Probe Failure	0x1
Battery Probe Warning	0x2
Temperature Probe Warning	0x8
Temperature Probe Failure	0x10
Redundancy Degraded	0x40
Redundancy Lost	0x80
Power Supply Warning	0x800
Power Supply Failure	0x1000
Power Supply Absent	0x2000
Hardware Log Failure	0x4000
Hardware Log Warning	0x8000
Server Absent	0x10000

**Table 11-2. Event Traps Filter Masks (continued)**

Event	Filter Mask Value
Server Failure	0x20000
KVM Absent	0x40000
KVM Failure	0x80000
IOM Absent	0x100000
IOM Failure	0x200000

- 4 Enable traps alerting by typing:

```
racadm config -g cfgTraps -o cfgTrapsEnable 1 -i <index>
```

where *<index>* is a value 1–4. The index number is used by the CMC to distinguish up to four configurable IP destinations for traps alerts.

- 5 Specify a destination IP address to receive the traps alert by typing:

```
racadm config -g cfgTraps -o cfgTrapsAlertDestIPAddr <IP address> -i <index>
```

where *<IP address>* is a valid IP address, and *<index>* is the index value you specified in step 4.

- 6 Specify the community name by typing:

```
racadm config -g cfgTraps -o cfgTrapsCommunityName <community name> -i <index>
```

where *<community name>* is the SNMP community to which the chassis belongs, and *<index>* is the index value you specified in steps 4 and 5.

You can configure up to four destination IP addresses to receive traps alerts. To add more IP addresses, repeat steps 2–6.



**NOTE:** The commands in steps 2–6 will overwrite any existing settings configured for the index you specify (1–4). To determine whether an index has previously configured values, type: `racadm get config -g cfgTraps -i <index>`. If the index is configured, values will appear for the `cfgTrapsAlertDestIPAddr` and `cfgTrapsCommunityName` objects.



To test an event trap for an alert destination:

```
racadm testtrap -i <index>
```

where <index> is a value 1-4 representing the alert destination you want to test. If you are unsure of the index number, type:

```
racadm testtrap -i <index>
```

## Configuring E-mail Alerts

When the CMC detects a chassis event, such as an environmental warning or a component failure, it can be configured to send an e-mail alert to one or more e-mail addresses.

Table 11-1 provides an overview of the events that trigger e-mail and SNMP alerts. For information on SNMP alerts, see "Configuring SNMP Alerts" on page 260.

You can add and configure e-mail alerts using the Web interface or RACADM.

### Using the Web Interface



**NOTE:** To add or configure e-mail alerts, you must have **Chassis Configuration Administrator** and **Network Administrator** privileges.

- 1 Log in to the CMC Web interface.
- 2 Select **Chassis** in the system tree.
- 3 Click the **Alert Management** tab. The **Chassis Events** page appears.
- 4 Enable alerting:
  - a Select the check boxes of the events for which you want to enable alerting. To enable all events for alerting, select the **Select All** check box.
  - b Click **Apply** to save your settings.
- 5 Click the **Email Alert Settings** sub-tab. The **Email Alert Destinations** page displays.
- 6 Specify the e-mail address(es) that will receive the alerts:
  - a Type a valid e-mail address in an empty **Destination Email Address** field.
  - b Click **Apply** to save your settings.

- 7 Click the **Network/Security** tab. The **Network Configuration** page appears.
- 8 Specify the SMTP server IP address:
  - a Locate the **SMTP (Email) Server IP Address** field, and then type the SMTP address.
  -  **NOTE:** You must configure the SMTP e-mail server to accept relayed e-mails from the CMC's IP address, a feature which is normally turned off in most mail servers due to security concerns. For instructions as to how to accomplish this in a secure manner, refer to the documentation that came with your SMTP server.
  - b Type the name of the party who will receive the alert (optional).
  - c Click **Apply Changes** to save your changes.

To send a test e-mail to an e-mail alert destination:

- 1 Log in to the CMC Web interface.
- 2 Select **Chassis** in the system tree.
- 3 Click the **Alert Management** tab. The **Chassis Events** page appears.
- 4 Click the **Email Alert Settings** sub-tab. The **Email Alert Destinations** page displays.
- 5 Click **Send** in the **Destination Email Address** column beside the destination.

### Using RACADM

- 1 Open a Telnet/SSH text console to the CMC and log in.
- 2 Enable alerting by typing:

```
racadm config -g cfgAlerting -o cfgAlertingEnable 1
```

-  **NOTE:** Only one filter mask may be set by both SNMP and e-mail alerting. You may skip step 3 if you have already set a filter mask.
- 3 Specify the events for which you want the CMC to generate by typing:

```
racadm config -g cfgAlerting -o  
cfgAlertingFilterMask <mask value>
```

where *<mask value>* is a hex value between 0x0 and 0x003ffffd.

Table 11-2 provides filter masks for each event type. For instructions on calculating the hex value for the filter mask you want to enable, see step 3 on "Using RACADM" on page 262.

- 4 Enable e-mail alerting by typing:

```
racadm config -g cfgEmailAlert -o  
cfgEmailAlertEnable 1 -i <index>
```

where *<index>* is a value 1–4. The index number is used by the CMC to distinguish up to four configurable destination e-mail addresses.

- 5 Specify a destination e-mail address to receive the e-mail alerts by typing:

```
racadm config -g cfgEmailAlert -o  
cfgEmailAlertAddress <e-mail address> -i <index>
```

where *<e-mail address>* is a valid e-mail address, and *<index>* is the index value you specified in step 4.

- 6 Specify the name of the party receiving the e-mail alert by typing:

```
racadm config -g cfgTraps -o  
cfgEmailAlertEmailName <e-mail name> -i <index>
```

where *<e-mail name>* is the name of the person or group receiving the e-mail alert, and *<index>* is the index value you specified in steps 4 and 5. The e-mail name can contain up to 32 alphanumeric characters, dashes, underscores, and periods. Spaces are not valid.

You can configure up to four destination e-mail addresses to receive e-mail alerts. To add more e-mail addresses, repeat steps 2–6.



**NOTE:** The commands in steps 2–6 will overwrite any existing settings configured for the index you specify (1–4). To determine whether an index has previously configured values, type: `racadm get config -g cfgEmailAlert -i <index>`. If the index is configured, values will appear for the `cfgEmailAlertAddress` and `cfgEmailAlertEmailName` objects.

## First Steps to Troubleshooting a Remote System

The following questions are commonly used to troubleshoot high-level problems in the managed system:

- 1 Is the system powered on or off?
- 2 If powered on, is the operating system functioning, crashed, or just frozen?
- 3 If powered off, did the power turn off unexpectedly?

## Monitoring Power and Executing Power Control Commands on the Chassis

You can use the Web interface or RACADM to:

- View the system's current power status.
- Perform an orderly shutdown through the operating system when rebooting, and power the system on or off.

For information about power management on the CMC and configuring power budget, redundancy, and power control, see "Power Management" on page 197.

### Viewing Power Budget Status

For instructions on viewing power budget status for the chassis, servers, and PSUs using either the Web interface or RACADM, see "Viewing Power Budget Status" on page 207.

### Executing a Power Control Operation

For instructions on powering on, powering off, resetting, or power-cycling the system using the CMC Web interface or RACADM, see "Executing Power Control Operations on the Chassis" on page 221, "Executing Power Control Operations on an IOM" on page 222, and "Executing Power Control Operations on a Server" on page 223.

## Viewing Chassis Summaries

The CMC provides rollup overviews of the chassis, primary and standby CMCs, iKVM, fans, temperature sensors, and I/O modules (IOMs).

## Using the Web Interface

To view summaries of the chassis, CMCs, iKVM, and IOMs:

- 1 Log in to the CMC Web interface.
- 2 Select **Chassis** in the system tree.
- 3 Click the **Properties** tab. The **Chassis Summary** page displays.

Table 11-3, Table 11-4, Table 11-5, and Table 11-6 describe the information provided.

**Table 11-3. Chassis Summary**

Item	Description
<b>Name</b>	Displays the name of the chassis. The name identifies the chassis on the network. For information on setting the name of the chassis, see "Editing Slot Names" on page 91.
<b>Model</b>	Displays the chassis model or manufacturer. For example, PowerEdge 2900.
<b>Service Tag</b>	Displays the service tag of the chassis. The service tag is a unique identifier provided by the manufacturer for support and maintenance.
<b>Asset Tag</b>	Displays the asset tag of the chassis.
<b>Location</b>	Displays the location of the chassis.
<b>CMC Failover Ready</b>	Indicates ( <b>Yes</b> , <b>No</b> ) whether the standby CMC (if present) is capable of taking over in the event of a failover condition.

**Table 11-4. CMC Summary**

Item	Description
<b>Primary CMC Information</b>	
<b>Name</b>	Displays the name of the CMC. For example, Primary CMC or Standby CMC.
<b>Description</b>	Provides a brief description of the purpose of the CMC.
<b>Date/Time</b>	Indicates the date and time set on the active or primary CMC.

**Table 11-4. CMC Summary (continued)**

<b>Item</b>	<b>Description</b>
<b>CMC Firmware Version</b>	Indicates the firmware version of the active or primary CMC.
<b>Firmware Last Updated</b>	Indicates when the firmware was last updated. If no updates have occurred, this property displays as N/A.
<b>CMC Hardware Version</b>	Indicates the hardware version of the active or primary CMC.
<b>IP Address</b>	Indicates the IP address of the CMC NIC.
<b>Gateway</b>	Indicates the gateway of the CMC NIC.
<b>Subnet Mask</b>	Indicates the subnet mask of the CMC NIC.
<b>MAC Address</b>	Indicates the MAC address for the CMC NIC. The MAC address is a unique identifier for the CMC over the network.
<b>Use DHCP (for NIC IP Address)</b>	Indicates whether the CMC is enabled to request and obtain automatically an IP address from the Dynamic Host Configuration Protocol (DHCP) server ( <b>Yes</b> or <b>No</b> ). The default setting for this property is <b>No</b> .
<b>Standby CMC Information</b>	
<b>Present</b>	Displays ( <b>Yes</b> , <b>No</b> ) whether a second (standby) CMC is installed.
<b>Standby Firmware Version</b>	Displays the CMC firmware version installed on the standby CMC.

**Table 11-5. iKVM Summary**

<b>Item</b>	<b>Description</b>
<b>Presence</b>	Indicates whether the iKVM module is present ( <b>Yes</b> or <b>No</b> ).
<b>Name</b>	Displays the name of the iKVM. The name identifies the iKVM on the network.
<b>Service Tag</b>	Displays the service tag of the chassis. The service tag is a unique identifier provided by the manufacturer for support and maintenance.
<b>Manufacturer</b>	Displays the iKVM model or manufacturer.

**Table 11-5. iKVM Summary (continued)**

<b>Item</b>	<b>Description</b>
<b>Part Number</b>	Displays the part number for the iKVM. The part number is a unique identifier provided by the vendor. Part number naming conventions differ from vendor to vendor.
<b>Firmware Version</b>	Indicates the firmware version of the iKVM.
<b>Hardware Version</b>	Indicates the hardware version of the iKVM.
<b>Power Status</b>	Indicates the power status of the iKVM: <b>On</b> , <b>Off</b> , <b>N/A</b> (Absent).
<b>Front Panel Enabled</b>	Indicates whether the front panel VGA connector is enabled ( <b>Yes</b> or <b>No</b> ).

**Table 11-6. IOM Summary**

<b>Item</b>	<b>Description</b>
<b>Location</b>	Indicates the slot occupied by the IOMs. Six slots are identified by group name (A, B, or C) and slot number (1 or 2). Slot names: <b>A-1</b> , <b>A-2</b> , <b>B-1</b> , <b>B-2</b> , <b>C-1</b> , or <b>C-2</b> .
<b>Presence</b>	Indicates whether the IOM is present ( <b>Yes</b> or <b>No</b> ).
<b>Name</b>	Displays the name of the IOM.
<b>Fabric</b>	Displays the type of fabric.
<b>Power Status</b>	Indicates the power status of the IOM: <b>On</b> , <b>Off</b> , or <b>N/A</b> (Absent).
<b>Service Tag</b>	Displays the service tag of the IOM. The service tag a unique identifier provided by the manufacturer for support and maintenance.

**Using RACADM**

- 1 Open a Telnet/SSH text console to the CMC and log in.
- 2 To view chassis and CMC summaries, type:
 

```
racadm getsysinfo
```

 To view the iKVM summary, type:
 

```
racadm getkvminfo
```

To view the IOM summary, type:

```
racadm getioinfo
```





## Viewing Chassis and Component Health Status

### Using the Web Interface

To view chassis and component health summaries:

- 1 Log in to the CMC Web interface.
- 2 Select **Chassis** in the system tree. The **Component Health** page displays. Health status for each component is indicated with an icon. Table 11-7 provides descriptions of each icon.

**Table 11-7. Health Status Indicators**

Item	Description
	OK Indicates that the component is present and communicating with the CMC.
	Informational Displays information about the component when there is no change in health status.
	Warning Indicates that only Warning alerts have been issued, and <b>corrective action must be taken within the time frame set by the administrator</b> . If corrective actions are not taken within administrator-specified time, it could lead to a component failure, communication failure between the component and the CMC, and a critical or severe failure that could affect the integrity of the chassis.
	Severe Indicates that at least one failure alert has been issued. This means that the CMC can still communicate with the component and that the health status reported is critical. <b>Corrective action must be taken immediately</b> . Failure to do so may cause the component to fail and stop communicating with the CMC.
	Unknown Displays when the chassis is first powered on. All chassis components initially are indicated as "unknown" until they are fully powered on.



**Table 11-7. Health Status Indicators (continued)**

Item	Description
No Value	Indicates that the component is absent from the slot, or the CMC cannot communicate with the component. <b>NOTE:</b> It is not possible for the chassis to be absent.

### Using RACADM

Open a Telnet/SSH text console to the CMC, log in, and type:

```
racadm modinfo
```

## Viewing the Event Logs

The **Hardware Log** and **CMC Log** pages display system-critical events that occur on the managed system.

### Viewing the Hardware Log

The CMC generates a hardware log of events that occur on the chassis. You can view the hardware log using the Web interface and remote RACADM.



**NOTE:** To clear the hardware log, you must have **Clear Logs Administrator** privilege.



**NOTE:** You can configure the CMC to send e-mail or SNMP traps when specific events occur. For information on configuring CMC to send alerts, see "Configuring SNMP Alerts" on page 260 and "Configuring E-mail Alerts" on page 265.

### Examples of hardware log entries

```
critical System Software event: redundancy lost
```

```
Wed May 09 15:26:28 2007 normal System Software  
event: log cleared was asserted
```

```
Wed May 09 16:06:00 2007 warning System Software  
event: predictive failure was asserted
```

```
Wed May 09 15:26:31 2007 critical System Software  
event: log full was asserted
```

```
Wed May 09 15:47:23 2007 unknown System Software  
event: unknown event
```

## Using the Web Interface

You can view, save a text file version of, and clear the hardware log in the CMC Web interface.

Table 11-8 provides descriptions of the information provided on the **Hardware Log** page in the CMC Web interface.

To view the hardware log:

- 1 Log in to the CMC Web interface.
- 2 Click **Chassis** in the system tree.
- 3 Click the **Logs** tab.
- 4 Click the **Hardware Log** sub-tab. The **Hardware Log** page displays.

To save a copy of the hardware log to your managed station or network:

Click **Save As**. A **Save File As** dialog box opens; select a location for a text file of the log.



**NOTE:** Because the log is saved as a text file, the graphical images used to indicate severity in the user interface do not appear. In the text file, severity is indicated with the words OK, Informational, Unknown, Warning, and Severe. The date and time entries appear in ascending order. If <SYSTEM BOOT> appears in the Date/Time column, it means that the event occurred during shut down or start up of any of the modules, when no date or time is available.





To clear the hardware log:

Click **Clear Log**.



**NOTE:** The CMC creates a new log entry indicating that the log was cleared.

**Table 11-8. Hardware Log Information**

Item	Description
Severity	 OK Indicates a normal event that does not require corrective actions.
	 Informational Indicates an informational entry on an event in which the Severity status has not changed.
	 Unknown Indicates a noncritical event for which <b>corrective actions should be taken soon</b> to avoid system failures.
	 Warning Indicates a critical event requiring immediate corrective actions to avoid system failures.
	 Severe Indicates a critical event that <b>requires immediate corrective actions</b> to avoid system failures.
Date/Time	Indicates the exact date and time the event occurred (for example, Wed May 02 16:26:55 2007). If no date/time appears, then the event occurred at System Boot.
Description	Provides a brief description, generated by the CMC, of the event (for example, Redundancy lost, Server inserted).

### Using RACADM

- 1 Open a Telnet/SSH text console to the CMC and log in.
- 2 To view the hardware log, type:  
`racadm getsel`  
To clear the hardware log, type:  
`racadm clrsel`

### Viewing the CMC Log

The CMC generates a log of chassis-related events.

 **NOTE:** To clear the hardware log, you must have **Clear Logs Administrator** privilege.

## Using the Web Interface

You can view, save a text file version of, and clear the CMC log in the CMC Web interface.

You can re-sort the log entries by Source, Date/Time, or Description by clicking the column heading. Subsequent clicks on the column headings reverse the sort.

Table 11-9 provides descriptions of the information provided on the **CMC Log** page in the CMC Web interface.

To view the CMC log:

- 1 Log in to the CMC Web interface.
- 2 Click **Chassis** in the system tree.
- 3 Click the **Logs** tab.
- 4 Click the **CMC Log** sub-tab. The **CMC Log** page displays.

To save a copy of the CMC log to your managed station or network, click **Save As**. A **Save File As** dialog box opens; select a location for a text file of the log.

**Table 11-9. CMC Log Information**

<b>Command</b>	<b>Result</b>
Source	Indicates the interface (such as the CMC) that caused the event.
Date/Time	Indicates the exact date and time the event occurred (for example, Wed May 02 16:26:55 2007).
Description	Provides a short description of the action, such as a login or a logout, login failure, or clearing the logs. Descriptions are generated by the CMC.

## Using RACADM

- 1 Open a Telnet/SSH text console to the CMC and log in.
- 2 To view the hardware log, type:  
`racadm getraclog`  
To clear the hardware log, type:  
`racadm clrraclog`

# Using the Diagnostic Console

The **Diagnostic Console** page enables an advanced user, or a user under the direction of technical support, to diagnose issues related to the chassis hardware using CLI commands.



**NOTE:** To modify these settings, you must have **Debug Command Administrator** privilege.

To access the **Diagnostic Console** page:

- 1 Log in to the CMC Web interface.
- 2 Click **Chassis** in the system tree.
- 3 Click the **Troubleshooting** tab.
- 4 Click the **Diagnostics** sub-tab. The **Diagnostic Console** page displays.

To execute a diagnostic CLI command, type the command into the **Enter RACADM Command** field, and then click **Submit** to execute the diagnostic command. A diagnostic results page appears.

To update the contents diagnostic results page, click **Refresh**.

To return to the **Diagnostic Console** page, click **Go Back to Diagnostic Console Page**.

The Diagnostic Console supports the commands listed in Table 11-10.

**Table 11-10. Supported Diagnostic Commands**

Command	Result
arp	Displays the contents of the address resolution protocol (ARP) table. ARP entries may not be added or deleted.
ipconfig	Displays the contents of the network interface table.
netstat	Prints the contents of the routing table.
ping <IP address>	Verifies that the destination <IP address> is reachable from the CMC with the current routing-table contents. You must type a destination IP address in the field to the right of this option. An Internet control message protocol (ICMP) echo packet is sent to the destination IP address based on the current routing-table contents.

**Table 11-10. Supported Diagnostic Commands (continued)**

Command	Result
gettracelog	Displays the trace log (may take a few seconds to display the log). The <code>gettracelog -i</code> command returns the number of records in the trace log. The <code>gettracelog -A</code> command returns the trace log without the record numbers. <b>NOTE:</b> This command is for Dell internal use only. <b>NOTE:</b> For more information about the <code>gettracelog</code> command, see "gettracelog" on page 322.

## Interpreting LED Colors and Blinking Patterns

The LEDs on the chassis provide information by color and blinking/no blinking:

- Steadily glowing, green LEDs indicate that the component is powered on. If the green LED is blinking, it indicates a critical but routine event, such as a firmware upload, during which the unit is not operational. It does not indicate a fault.
- A blinking amber LED on a module indicates a fault on that module.
- Blue, blinking LEDs are configurable by the user and used for identification (see "Configuring LEDs to Identify Components on the Chassis" on page 259).

Table 11-11 lists common LED patterns on the chassis.

**Table 11-11. LED Color and Blinking Patterns**

Component	LED Color, Blinking Pattern	Meaning
CMC	Green, glowing steadily	Powered on
	Green, blinking	Firmware is being uploaded
	Green, dark	Powered off
	Blue, glowing steadily	Master/primary
	Blue, blinking	User-enabled module identifier
	Amber, glowing steadily	Not used
	Amber, blinking	Fault

**Table 11-11. LED Color and Blinking Patterns (continued)**

<b>Component</b>	<b>LED Color, Blinking Pattern</b>	<b>Meaning</b>
iKVM	Blue, dark	Slave/standby
	Green, glowing steadily	Powered on
	Green, blinking	Firmware is being uploaded
	Green, dark	Powered off
	Amber, glowing steadily	Not used
	Amber, blinking	Fault
Server	Amber, dark	No fault
	Green, glowing steadily	Powered on
	Green, blinking	Firmware is being uploaded
	Green, dark	Powered off
	Blue, glowing steadily	Normal
	Blue, blinking	User-enabled module identifier
	Amber, glowing steadily	Not used
IOM (Common)	Amber, blinking	Fault
	Blue, dark	No fault
	Green, glowing steadily	Powered on
	Green, blinking	Firmware is being uploaded
	Green, dark	Powered off
	Blue, glowing steadily	Normal/stack master
	Blue, blinking	User-enabled module identifier
	Amber, glowing steadily	Not used
	Amber, blinking	Fault
Blue, dark	No fault/stack slave	

**Table 11-11. LED Color and Blinking Patterns (continued)**

<b>Component</b>	<b>LED Color, Blinking Pattern</b>	<b>Meaning</b>
IOM (Pass through)	Green, glowing steadily	Powered on
	Green, blinking	Not used
	Green, dark	Powered off
	Blue, glowing steadily	Normal
	Blue, blinking	User-enabled module identifier
	Amber, glowing steadily	Not used
	Amber, blinking	Fault
	Blue, dark	No fault
Fan	Green, glowing steadily	Fan working
	Green, blinking	Not used
	Green, dark	Powered off
	Amber, glowing steadily	Fan type not recognized, update CMC firmware
	Amber, blinking	Fan fault; tachometer out of range
	Amber, dark	Not used
PSU	(Oval) Green, glowing steadily	AC OK
	(Oval) Green, blinking	Not used
	(Oval) Green, dark	AC Not OK
	Amber, glowing steadily	Not used
	Amber, blinking	Fault
	Amber, dark	No fault
	(Circle) Green, glowing steadily	DC OK
	(Circle) Green, dark	DC Not OK



# Troubleshooting a Non-responsive CMC

 **NOTE:** It is not possible to log in to the standby CMC using a serial console.

If you cannot log in to the CMC using any of the interfaces (the Web interface, Telnet, remote RACADM, or serial), you can verify CMC functionality by observing the LEDs on the CMC, obtaining recovery information using the DB-9 serial port, or recovering the CMC firmware image.

## Observing the LEDs to Isolate the Problem

Facing the front of the CMC as it is installed in the chassis, you will see two LEDs on the left side of the card.

Top LED — The top green LED indicates power. If it is NOT on:

- 1 Verify that you have AC present to at least one power supply.
- 2 Verify that the CMC card is seated properly. You can release/pull on the ejector handle, remove the CMC, reinstall the CMC making sure the board is inserted all the way and the latch closes correctly.

Bottom LED — The bottom LED is multi-colored. When the CMC is active and running, and there are no problems, the bottom LED is blue. If it is amber, a fault was detected. The fault could be caused by any of the following three events:

- A core failure. In this case, the CMC board must be replaced.
- A self-test failure. In this case, the CMC board must be replaced.
- An image corruption. In this case, you can recover the CMC by uploading the CMC firmware image.

 **NOTE:** A normal CMC boot/reset takes over a minute to fully boot into its OS and be available for login. The blue LED is enabled on the active CMC. In a redundant, two-CMC configuration, only the top green LED is enabled on the standby CMC.

## Obtain Recovery Information From the DB-9 Serial Port

If the bottom LED is amber, recovery information should be available from the DB-9 serial port located on the front of the CMC.

To obtain recovery information:

- 1 Install a NULL modem cable between the CMC and a client machine.
- 2 Open a terminal emulator of your choice (such as HyperTerminal or Minicom). Set up: 8 bits, no parity, no flow control, baud rate 115200. A core memory failure will display an error message every 5 seconds.
- 3 Press <Enter>. If a **recovery** prompt appears, additional information is available. The prompt will indicate the CMC slot number and failure type. To display failure reason and syntax for a few commands, type

```
recover
```

and then press <Enter>. Sample prompts:

```
recover1[self test] CMC 1 self test failure
```

```
recover2[Bad FW images] CMC2 has corrupted images
```

- If the prompt indicates a self test failure, there are no serviceable components on the CMC. The CMC is bad and must be returned to Dell.
- If the prompt indicates **Bad FW Images**, then follow the steps in "Recovering the Firmware Image" on page 282 to fix the problem.

## Recovering the Firmware Image

The CMC enters recover mode when a normal CMC OS boot is not possible. In recover mode, a small subset of commands are available that allow you to reprogram the flash devices by uploading the firmware update file, **firmimg.cmc**. This is the same firmware image file used for normal firmware updates. The recovery process displays its current activity and boots to the CMC OS upon completion.

When you type `recover` and then press <Enter> at the **recovery** prompt, the recover reason and available sub-commands display. An example recover sequence may be:

```
recover getniccfg
```

```
recover setniccfg 192.168.0.120 255.255.255.0  
192.168.0.1
```

```
recover ping 192.168.0.100
```

```
recover fwupdate -g -a 192.168.0.100
```



**NOTE:** Connect the network cable to the left most RJ45



**NOTE:** In recover mode, you cannot ping the CMC normally because there is no active network stack. The **recover ping <TFTP server IP>** command allows you to ping to the TFTP server to verify the LAN connection. You may need to use the **recover reset** command after **setniccfg** on some systems.

## Troubleshooting Network Problems

The internal CMC Trace Log allows you to debug CMC alerting and networking. You can access the trace log using the CMC Web interface (see "Using the Diagnostic Console" on page 277) or RACADM (see "Using the RACADM Command Line Interface" on page 65 and "gettracelog" on page 322).

The trace log tracks the following information:

- DHCP — Traces packets sent to and received from a DHCP server.
- IP — Traces IP packets sent and received.
- DDNS — Traces dynamic DNS update requests and responses.

The trace log may also contain CMC firmware-specific error codes that are related to the internal CMC firmware, not the managed system's operating system.



**NOTE:** The CMC will not echo an ICMP (ping) with a packet size larger than 1500 bytes.

## Troubleshooting Alerting

Use logged SNMP trap information to troubleshoot a particular type of CMC alert. SNMP trap deliveries are logged in the Trace Log by default. However, since SNMP does not confirm delivery of traps, use a network analyzer or a tool such as Microsoft's **snmputil** to trace the packets on the managed system.

You can configure SNMP alerts using the Web interface. For information, see "Configuring SNMP Alerts" on page 260.



# RACADM Subcommands

## ? and ? <command>

 **NOTE:** To use this subcommand, you must have **CMC Login User** privilege.

### Description

? lists all of the subcommands you can use with the **racadm** command and a one-line description of each subcommand.

? <command> displays the syntax for the specified command.

 **NOTE:** You can also use the **help** and **help <command>** commands to obtain the same information.

### Usage

```
racadm ?
```

```
racadm ? <command>
```

### Examples

 **NOTE:** The following output example shows only part of the actual output for the **racadm ?** command. Descriptions shown in this example may vary slightly from the descriptions in your **racadm** session.

- racadm ?
 

```

help                -- list racadm subcommand
description
help <subcommand> -- display usage summary for a
subcommand
?                  -- list racadm subcommand
description
? <subcommand>   -- display usage summary for a
subcommand
arp                -- display the networking arp table
chassisaction     -- execute chassis or switch
power-up/down/cycle or KVM powercycle
```

```

clrraclog      -- clear the CMC log
clrssel       -- clear the System Event Log (SEL)
cmcchangeover -- Changes the redundant state of
the CMC from active to standby and vice versa
config        -- modify CMC configuration
properties
LEDs on a module
...
setniccfg     -- modify network configuration
properties
setractime    -- set the time on the CMC
setslotname   -- sets the name of the slot in the
chassis
setsysinfo    -- set the chassis name and chassis
location
sslcertview   -- display a CA/server certificate
in the CMC
sslcsrgen     -- generate a certificate CSR from
the CMC
testemail     -- test CMC e-mail notifications
testtrap     -- test CMC SNMP trap notifications

```

- racadm ? getsysinfo

```

getsysinfo -- display general CMC and system
information

```

Usage:

```

getsysinfo [-d] [-c] [-A]

```

```

-d : show cmc information

```

```

-c : show chassis information

```

```

-A : do not show headers or labels

```

## arp



**NOTE:** To use this subcommand you must have **Administrator** privilege.

### Description

Display the Address Resolution Protocol (ARP) table. This table stores the mapping of IP numbers to MAC addresses of the NICs in the chassis.

## Example

- `racadm arp`

Address		HWtype	HWaddress	Flags
Mask	Iface			
143.166.152.3	eth0	ether	00:07:84:A7:CE:BC	C
143.166.152.2	eth0	ether	00:07:84:7B:9F:FC	C
143.166.152.1	eth0	ether	00:00:0C:07:AC:0A	C
143.166.152.113	eth0	ether	00:15:C5:48:9C:1D	C

## chassisaction



**NOTE:** To use this subcommand, you must have **Chassis Control Administrator** privilege.

### Description

Executes a power action on the chassis, iKVM, or a server.

### Usage

```
racadm chassisaction [-m <module>] <action>
```

### Options

Table A-1 describes `chassisaction` subcommand options.

**Table A-1. chassisaction Subcommand Options**

Option	Description
<code>-m &lt;module&gt;</code>	Specifies the module on which you want the action carried out. <code>&lt;module&gt;</code> may be one of the following: <ul style="list-style-type: none"><li>• <code>chassis</code></li><li>• <code>switch-n</code> where <code>n=1-6</code></li><li>• <code>kvm</code></li></ul>

**Table A-1. chassisaction Subcommand Options (continued)**

Option	Description
<action>	Specifies the action you want to execute on the specified module. <action> may be one of the following: <ul style="list-style-type: none"><li>• <code>powerdown</code> — (Chassis only) Powers down the chassis.</li><li>• <code>powerup</code> — (Chassis only) Powers up the chassis.</li><li>• <code>powercycle</code> — Power cycles the module.</li><li>• <code>nongraceshutdown</code> — (Chassis only) Shutdown the chassis non-gracefully.</li><li>• <code>reset</code> — Performs a hard reset of the module.</li></ul>

**Example**

- `racadm chassisaction -m switch-3 reset`  
Module power operation successful.

## clrraclog



**NOTE:** To use this subcommand, you must have **Clear Logs Administrator** privilege.

**Description**

Removes all existing records from the CMC log. A new log entry is added to record the date and time when the log was cleared, and the user who cleared the log.



**NOTE:** To view the CMC log, use `getraclog`. For information about the CMC log, see "Viewing the CMC Log" on page 275.

**Usage**

```
racadm clrraclog
```

**Output**

The CMC log was cleared successfully.



## clrsel

 **NOTE:** To use this subcommand, you must have **Clear Logs Administrator** privilege.

### Description

Removes all existing records from the system events log (SEL, or hardware log). A new log entry is added to record the date and time when the log was cleared, and the user who cleared the log.

 **NOTE:** To view the hardware log, use **getsel**. For information about the hardware log, see "Viewing the Hardware Log" on page 273.

### Usage

```
racadm clrsel
```

### Output

```
The SEL was cleared successfully.
```

## cmcchangeover

 **NOTE:** To use this subcommand, you must have **Administrator** privilege.

### Description

Changes the state of the CMC from active to standby, or vice versa, in a redundant CMC configuration. This subcommand is useful for remote debugging or testing purposes.

 **NOTE:** This command is valid only in redundant CMC environments. For more information, see "Understanding the Redundant CMC Environment" on page 51.

### Usage

```
racadm cmcchangeover
```

### Output

```
CMC failover initiated successfully.
```

# config

 **NOTE:** To use this subcommand, you must have **Chassis Configuration Administrator** privilege.

## Description

Sets the CMC configuration parameters individually or in a batch as part of a configuration file. If the data is different, that CMC object is written with the new value.

## Usage

```
racadm config -g <group> -o <object> <value>
racadm config -g <group> -o <object> -i <index>
<value>
racadm config -f <filename>
```

## Options

Table A-2 describes the **config** subcommand options.

**Table A-2. config Subcommand Options**

Option	Description
-g <group>	Specifies the group containing the object that is to be set. Must be used with the -o option. Table A-3 lists the group names that may be specified with this option.
-o <object>	Specifies the object name that is written with the string <value>. Must be used with the -g option.
-i <index>	Specifies a unique group name. Only valid for indexed groups. The index is specified here by the index value (a decimal integer from 1–16).
<value>	Indicates the value to which you want the specified object set.
-f <filename>	Specifies the file name to use as a configuration source.

## Property Groups



**NOTE:** Appendix B, "CMC Property Database Group and Object Definitions" on page 347, provides details about the property groups. See also "getconfig" on page 299.

Table A-3 lists the property groups that can be specified with the `-g` option.

**Table A-3. RACADM Property Groups**

Group	Description
cfgLanNetworking	Configures network related properties
cfgRemoteHosts	Enables/disables and configures firmware updates and SMTP e-mail alerting
cfgUserAdmin	Configures CMC users
cfgEmailAlert	Configures CMC e-mail alerting
cfgSessionManagement	Sets the maximum number of remote sessions allowed to connect to CMC at a time
cfgSerial	Enables/disables and configures serial console
cfgNetTuning	Configures CMC network tuning
cfgOobSnmpp	Enables/disables and configures SNMP traps for the CMC
cfgTraps	Displays information for and configures delivery of SNMP traps for a specific user
cfgAlerting	Enables or disables SNMP event trap alerting and sets the event filter
cfgRacTuning	Configures CMC tuning parameters
cfgRacSecurity	Configures settings related to the CMC SSL certificate signing request (CSR) feature
cfgActiveDirectory	Configures Microsoft® Active Directory® properties
cfgStandardSchema	Configures the Standard Schema settings for Active Directory
cfgChassisPower	Configures power for the chassis
cfgServerInfo	Configures a server in the chassis
cfgKVMInfo	Displays information for and configures the iKVM

## Output

The **config** subcommand generates error output when it encounters any of the following:

- Invalid syntax, group name, object name, index, or other invalid database members
- Insufficient user privileges
- RACADM CLI failures
- The **config** subcommand returns an indication of how many configuration objects were written out of how many total objects were in the .cfg file.

## Examples

- ```
racadm config -g cfgLanNetworking -o  
cfgNicIpAddress 10.35.10.100
```

Sets the **cfgNicIpAddress** configuration parameter (object) to the value 10.35.10.110. This IP address object is contained in the group **cfgLanNetworking** (see "cfgLanNetworking" on page 349).

- ```
racadm config -f myrac.cfg
```

Configures or reconfigures the CMC. You can create the **myrac.cfg** file using the **getconfig** command. You can also manually edit the **myrac.cfg** file, as long as you adhere to the parsing rules (see "Parsing Rules" on page 83).



**NOTE:** The **myrac.cfg** file does not contain password information. To include this password information in the file, you must input it manually.

## deploy



**NOTE:** To use this subcommand, you must have **Server Administrator** privilege.

## Description

Configures the static IP address, subnet mask, gateway, and password for the root user on the iDRAC for the specified server.

 **NOTE:** This subcommand is valid only if the DHCP option is disabled for the specified server. When DHCP is enabled, the server automatically obtains an IP address, subnet mask, and gateway from the DHCP server. To determine whether DHCP is enabled for the server, use **getniccfg** (see "getniccfg" on page 309). To enable or disable DHCP, use **setniccfg** (see "setniccfg" on page 335).

 **NOTE:** You can also use **setniccfg** to configure static IP address, subnet mask, and gateway, as well as DHCP, speed, and duplex properties. For more information, see "setniccfg" on page 335.

## Usage

```
racadm deploy -m <module> -u root -p <password>  
-s <ipaddress> <subnet> <gateway>
```

## Options

Table A-4 describes the **deploy** subcommand options.

**Table A-4. deploy Subcommand Options**

Option	Description
-u root	Indicates that the <i>&lt;password&gt;</i> will be supplied for the root user on the server. <b>root</b> is a constant parameter, the only value that is valid with the -u option.
-m <module>	Specifies the server you want to configure. <b>Legal values:</b> <b>server-n</b> , where <i>n</i> =1–16
-p <password>	Specifies the password for the root user on the server.
-s <ipaddress subnet gateway>	Sets the IP address, subnet mask, and gateway for the specified server, separated by single spaces. <ul style="list-style-type: none"><li>• <b>ipaddress</b> — A string representing a valid IP address. For example, 192.168.0.20.</li><li>• <b>subnet</b> — A string representing a valid subnet mask. For example, 255.255.255.0.</li><li>• <b>gateway</b> — A string representing a valid subnet mask. For example, 192.168.0.1.</li></ul>

## Example

- `racadm deploy server-8 -s 192.168.0.20  
255.255.255.0 192.168.0.1`

The server was deployed successfully.

## feature



**NOTE:** To use this subcommand, you must have **Chassis Configuration Administrator** privilege.

### Description

Displays all active chassis features. The information displayed includes feature name, date activated, and the serial number of the SD card used to activate the feature.



**NOTE:** The **feature** subcommand must be run while the chassis is powered off to deactivate FlexAddress or the command will return an error.

### Usage

```
racadm feature [-s] [-d -c <featurename>]  
<featurename> = FlexAddress
```

### Options

Table A-5 describes the **feature** subcommand options.

**Table A-5. feature Subcommand Options**

Option	Description
-d -c <featurename>	Deactivates feature.
-s	Lists active features.

### Example

- `racadm feature -d -c flexaddress  
feature FlexAddress is deactivated on the chassis  
successfully`

- `racadm feature -s`  
 Feature = FlexAddress  
 Date Activated = 8 April 2008 - 10:39:40  
 Feature installed from SD card SN = 01122334455

## featurecard



**NOTE:** To use this subcommand, you must have **Chassis Configuration Administrator** privilege.

### Description

Verifies proper SD card installation and displays SD card status. The table below lists the status messages returned by the command.

**Table A-6. Status Messages Returned by featurecard -s Command**

Status Message	Actions
No feature card inserted.	Check the CMC to verify that the SD card was properly inserted. In a redundant CMC configuration, make sure the CMC with the SD feature card installed is the active CMC and not the standby CMC.
The feature card inserted is valid and contains the following feature(s) FlexAddress: The feature card is bound to this chassis	No action required.
The feature card inserted is valid and contains the following feature(s) FlexAddress: The feature card is bound to another chassis, svctag = ABC1234, SD card SN = 01122334455	Remove the SD card; locate and install the SD card for the current chassis.
The feature card inserted is valid and contains the following feature(s) FlexAddress: The feature card is not bound to any chassis	The feature card can be moved to another chassis, or can be reactivated on the current chassis. To reactivate on the current chassis, enter <code>racadm racreset</code> until the CMC module with the feature card installed becomes active.

## Usage

```
racadm featurecard -s
```

## Options

Table A-7 describes the **featurecard** subcommand options.

**Table A-7. featurecard Subcommand Options**

Option	Description
-s	Lists active SD card features and SD card status.

## Example

```
racadm featurecard -s
```

- `racadm featurecard -s`

The feature card inserted is valid and contains the following feature(s) FlexAddress: The feature card is bound to this chassis

# fwupdate



**NOTE:** To use this subcommand, you must have **Chassis Configuration Administrator** privilege.

## Description

Updates the firmware on the active CMC, standby CMC, or iKVM. Also performs updates to iDRAC firmware when the existing firmware is corrupted.



**NOTE:** Running the **fwupdate** subcommand to update the firmware on the primary CMC causes all Telnet and Web connections to be dropped. To monitor the progress of the update, use the **-s** option. During update of all other modules, including the standby CMC, the primary CMC continues to run normally without resetting.



**NOTE:** The **fwupdate** subcommand may only be executed on one device at a time.



## Usage

```
racadm fwupdate -g -u -a <IP address> -d <path>
[-m <module>]
```

```
racadm fwupdate -s
```

## Options

Table A-8 describes the **fwupdate** subcommand options.

**Table A-8. fwupdate Subcommand Options**

Option	Description
-d <path>	Specifies the source path where the firmware image resides. <b>Default:</b> local directory on CMC if '-g' option is absent. If '-g' is used, defaults to directory configured on the TFTP server
-g	Downloads the firmware update using the TFTP server.
-u	Performs firmware update operation (used with -g).
-a <IP address>	Specifies the TFTP server IP address used for the firmware image (used with -g).
-m <module>	Specifies the module to be updated. <module> is one of the following values: <ul style="list-style-type: none"><li>• cmc-active (default)</li><li>• cmc-standby</li><li>• kvm</li><li>• server-n where n = 1-16</li></ul>
-s	Displays the current status of the firmware update.



**NOTE:** Wait for the file to finish transferring from the TFTP server before you check the status of the update.

## Example

- ```
racadm fwupdate -g -u -a 192.168.0.120 -d
firmimg.cmc -m cmc-active
```

TFTP firmware update has been initiated. This update process may take several minutes to complete.

Firmware update complete.

- `racadm fwupdate -s -m cmc-active`

Firmware update in progress.

## getassettag



**NOTE:** To use this subcommand, you must have **CMC Login User** privilege.

### Description

Displays the asset tag for the chassis.

### Usage

```
racadm getassettag [-m <module>]
```

### Options

Table A-9 describes the `getassettag` subcommand options.

**Table A-9. getassettag Subcommand Options**

| Option                         | Description                                                                                                                                                                                                     |
|--------------------------------|-----------------------------------------------------------------------------------------------------------------------------------------------------------------------------------------------------------------|
| <code>-m &lt;module&gt;</code> | Specifies the module whose asset tag you want to view.<br><br>Legal value: <code>chassis</code><br><br>Because there is only one legal value, you can obtain the same output if you do not include this option. |

### Example

- `racadm getassettag -m chassis`

or

```
racadm getassettag
```

```
chassis 78373839-33
```

## getchassisname

 **NOTE:** To use this subcommand, you must have **CMC Login User** privilege.

### Description

Displays the name of the chassis.

### Usage

```
racadm getchassisname
```

### Example

- ```
racadm getchassisname  
PowerEdge 2955
```

## getconfig

 **NOTE:** To use this subcommand, you must have **Chassis Configuration Administrator** privilege.

### Description

Displays CMC configuration parameters and allows you to save CMC configuration groups to a .cfg file.

### Usage

```
racadm getconfig -g <groupName>  
racadm getconfig -g <groupName> -o <object>  
racadm getconfig -g <groupName> -i <index>  
racadm getconfig -u <username>  
racadm getconfig -h  
racadm getconfig -f <filename>
```

## Options

Table A-10 describes the **getconfig** subcommand options.

**Table A-10. getconfig Subcommand Options**

Option	Description
-g <groupName>	Specifies the group containing the object that is to be set. Must be used with the -o option. Table A-11 lists the groups you can specify.
-o <objectName>	Specifies the object name that is written with the string <value>. Must be used with the -g option.
-i <index>	Specifies a unique group name. Only valid for indexed groups. The index is specified by the index value (a decimal integer from 1–16).
-u	Displays the group associated with a specific user.
-h	Displays a list of available configuration groups.
-f <filename>	Saves CMC configuration in a .cfg. file using the specified file name.

## Property Groups



**NOTE:** "CMC Property Database Group and Object Definitions" on page 347, provides details about these property groups. See also "config" on page 290.

Table A-11 lists the property groups that can be specified with the **getconfig** subcommand -g option.

**Table A-11. Property Groups for the getconfig Subcommand**

Property Group	Description
idRacInfo (read only)	Displays version, build number, and product information for the CMC.
cfgLanNetworking	Configures network related properties.
cfgCurrentLanNetworking (read only)	Displays the current CMC NIC properties.
cfgRemoteHosts	Enables/disables and configures firmware updates and SMTP e-mail alerting.

**Table A-11. Property Groups for the getconfig Subcommand (continued)**

<b>Property Group</b>	<b>Description</b>
cfgUserAdmin	Configures CMC users.
cfgEmailAlert	Configures SMTP e-mail alerts.
cfgSessionManagement	Sets the maximum number of remote sessions allowed to connect to CMC at a time.
cfgSerial	Enables/disables and configures serial console.
cfgNetTuning	Configures CMC network tuning.
cfgOobSnmp	Enables/disables and configures SNMP traps for the CMC.
cfgTraps	Configures delivery of SNMP traps for a specific user.
cfgAlerting	Enables or disables SNMP event trap alerting and sets the event filter.
cfgRacTuning	Configures CMC tuning parameters.
cfgRacSecurity	Configures settings related to the CMC SSL certificate signing request (CSR).
cfgActiveDirectory	Configures Microsoft Active Directory properties.
cfgStandardSchema	Configures the Standard Schema settings for Active Directory.
cfgChassisPower	Configures power for the chassis
cfgServerInfo	Configures a server in the chassis
cfgKVMInfo	Displays information for and configures the iKVM

### **Output**

This subcommand generates error output upon encountering either of the following:

- Invalid syntax, group name, object name, index, or other invalid database members
- RACADM CLI transport failures

If errors are not encountered, this subcommand displays the contents of the specified configuration.

### Examples:

- `racadm getconfig -g cfgLanNetworking`  
Displays all of the configuration properties (objects) that are contained in the group `cfgLanNetworking` (see "cfgLanNetworking" on page 349).
- `racadm getconfig -f myrac.cfg`  
Saves all group configuration objects from the CMC to `myrac.cfg`.
- `racadm getconfig -h`  
Displays a list of the available configuration groups on the CMC.
- `racadm getconfig -u root`  
Displays the configuration properties for the user named root.

## getdcinfo



**NOTE:** To use this subcommand, you must have **CMC Login User** privilege.

### Description

Displays general I/O module and daughter card configuration information.



**NOTE:** Fabric verification for server DCs is performed only when the chassis is powered on. When the chassis is on standby power, the iDRACs on the server modules remain powered off and thus are unable to report the server's DC fabric type. The DC fabric type may not be reported in the CMC user interface until the iDRAC on the server is powered on.

### Usage

```
racadm getdcinfo
```

### Example

- `racadm getdcinfo`

```
Group 1 I/O Type : Gigabit Ethernet
Group 2 I/O Type : None
Group 3 I/O Type : None
```

<IO#>	<Type>	<State>
switch-1	Gigabit Ethernet	OK

switch-2	None	OK
switch-3	None	OK
switch-4	None	OK
switch-5	None	OK
switch-6	None	OK

<Server#>	<DC1 Type>	<DC1 State>	<DC2 Type>	<DC2 State>
server-1	Unsupported	Invalid	Unsupported	Invalid
server-2	None	OK	None	OK
server-3	None	OK	None	OK
server-4	None	OK	None	OK
server-5	None	OK	None	OK
server-6	None	OK	None	OK
server-7	None	OK	None	OK
server-8	None	OK	None	OK
server-9	None	OK	None	OK
server-10	None	OK	None	OK
server-11	None	OK	None	OK
server-12	None	OK	None	OK
server-13	None	OK	None	OK
server-14	None	OK	None	OK
server-15	None	OK	None	OK
server-16	None	OK	None	OK

## getflexaddr



**NOTE:** To use this subcommand, you must have **Chassis Configuration Administrator** privilege.

### Description

Displays enabled/disabled status for the entire chassis or on a per slot basis. If used with `-i`, the command allows a slot to be enabled.



**NOTE:** If there are no activated features on the chassis, the command will return an error message. If the slot is empty, the command will return an error message.

### Usage

```
racadm getflexaddr [-i <slot#>]
```

```
<slot#> = 1 to 16
```

## Options

Table A-12 describes the `getflexaddr` subcommand options.

**Table A-12. getflexaddr Subcommand Options**

Option	Description
-i	Allows slots to be selected

### Example

```
• racadm getflexaddr
  <Slot#>  <SlotName>  <Status>
    1      slot-1     enabled
    2      slot-2     enabled
    3      slot-3     disabled
    4      slot-4     disabled
    5      slot-5     disabled
    6      slot-6     disabled
    7      slot-7     disabled
    8      slot-8     disabled
    9      slot-9     disabled
   10     slot-10    disabled
   11     slot-11    disabled
   12     slot-12    disabled
   13     slot-13    disabled
   14     slot-14    disabled
   15     slot-15    disabled
   16     slot-16    disabled

  <Fabric>  <Type>      <Status>
```



```

Fabric-A  ethernet      disabled
Fabric-B  iSCSI           enabled
Fabric-C  fiber channel  enabled

```

- `racadm getflexaddr -i 1`  
Slot-1 flexaddress enabled = 1

```

<Fabric> <Server-Assigned>          <Chassis-Assigned>
slot1-A1 00:1A:A0:FF:CE:8C          00:18:8B:FF:D9:BB(active)
          00:1A:A0:FF:CE:8D          00:18:8B:FF:D9:BC(active)
slot1-A2 00:1A:A0:FF:CE:8E          00:18:8B:FF:D9:BD(active)
          00:1A:A0:FF:CE:8F          00:18:8B:FF:D9:BE(active)
slot1-B1 00:1D:09:71:AF:20          00:18:8B:FF:D9:BF(active)
          00:1D:09:71:AF:21          00:18:8B:FF:D9:C0(active)
slot1-B2 00:1D:09:71:AF:22          00:18:8B:FF:D9:C1(active)
          00:1D:09:71:AF:23          00:18:8B:FF:D9:C2(active)
slot1-C1 10:00:00:00:C9:63:52:6C    20:01:00:18:8B:FF:D9:C3(active)
slot1-C2 10:00:00:00:C9:63:52:6B    20:02:00:18:8B:FF:D9:C3(active)

```

## getioinfo

 **NOTE:** To use this subcommand, you must have **CMC Login User** privilege.

### Description

Displays general information about the I/O modules on the chassis.

 **NOTE:** The fabric type may be any supported I/O fabric type, such as Ethernet, Fiber Channel, and Infiniband.

### Usage

```
racadm getioinfo
```

### Example

```
racadm getioinfo
```

```

<IO>      <Name>          <Type>          <presence>
<POST>    <Power>
switch-1  Ethernet Passthrough  Gigabit Ethernet  Present

```

OK		ON		
switch-2	N/A		None	Not Present
N/A		N/A		
switch-3	N/A		None	Not Present
N/A		N/A		
switch-4	N/A		None	Not Present
N/A		N/A		
switch-5	N/A		None	Not Present
N/A		N/A		
switch-6	N/A		None	Not Present
N/A		N/A		

## getkvminfo



**NOTE:** To use this subcommand, you must have **CMC Login User** privilege.

### Description

Displays iKVM module information.

### Usage

```
racadm getkvminfo
```

### Example

```
racadm getkvminfo
```

```
<module>  <presence>      <model>                <FW Version>  <status>
KVM        Present          Avocent iKVM Switch    00.05.00.04   Ready
```

## getled



**NOTE:** To use this subcommand, you must have **CMC Login User** privilege.

### Description

Displays the LED settings on a module: blinking, not blinking, or unknown (for empty slots).

### Usage

```
racadm getled -m <module>
```

Table A-13 describes the `getled` subcommand options.

**Table A-13. getled Subcommand Options**

Option	Description
<code>-m &lt;module&gt;</code>	Specifies the module whose LED settings you want to view.  <module> can be one of the following: <ul style="list-style-type: none"><li>• <code>server-n</code> where <math>n=1-16</math></li><li>• <code>switch-n</code> where <math>n=1-6</math></li><li>• <code>chassis</code></li><li>• <code>cmc-active</code></li></ul>

### Examples

- ```
racadm getled -m server-10  
  <module>      <state>  
  server-10     Blinking
```
- ```
racadm getled -m chassis  
  <module>      <state>  
  server-10     Not blinking
```

## getmacaddress



**NOTE:** To use this subcommand, you must have **CMC Login User** privilege.

### Description

Displays the MAC addresses for all modules or for a specified module.

### Usage

```
racadm getmacaddress [-m <module>]
```

### Options

Table A-14 describes the `getmacaddress` subcommand options.

**Table A-14. getmacaddress Subcommand Options**

Option	Description
-m <module>	Specifies the module whose MAC address you want to view. <module> may be one of the following: <ul style="list-style-type: none"><li>• chassis</li><li>• server-<i>n</i> where <i>n</i>=1-16</li><li>• switch-<i>n</i> where <i>n</i>=1-6</li></ul>

**Example**

```
racadm getmacaddress -m server-1
```

```
<Name>          <BMC MAC Address>          <NIC1 MAC Address>
ss>          <NIC2 MAC Address>
server-
1           00:01:44:56:22:CC          00:18:8B:FC:60:40
           00:18:8B:FC:60:42
```

## getmodinfo



**NOTE:** To use this subcommand, you must have **CMC Login User** privilege.



The service tag field is blank for modules that do not have service tags.

### Description

Displays configuration and status information for all modules or a specified module (server, switch, CMC, fan unit, or power supply unit) in the chassis.

### Usage

```
racadm getmodinfo [-m <module>] [-A]
```

### Options

Table A-15 describes the **getmodinfo** subcommand options.

**Table A-15. getmodinfo Subcommand Options**

Option	Description
-m <module>	<p>Specifies the module whose configuration and status information you want to view. The default command (no options) displays information about all major components in the chassis.</p> <p>&lt;module&gt; may be any of the following values:</p> <ul style="list-style-type: none"> <li>• server-<i>n</i> where <i>n</i>=1-16</li> <li>• switch-<i>n</i> where <i>n</i>=1-6</li> <li>• CMC-<i>n</i> where <i>n</i>=1 (primary), 2 (standby)</li> <li>• fan-<i>n</i> where <i>n</i>=1-9</li> <li>• ps-<i>n</i> where <i>n</i>=1-6</li> <li>• kvm</li> <li>• chassis</li> </ul>
-A	Suppresses headers and labels in the output.

**Example**

```
racadm getmodinfo -m switch-1
```

```

<module>          <presence>          <pwrState>          <health>
<svcTag>
Switch-
1                Present                ON                OK
                ABC1234

```

**getniccfg**

**NOTE:** To use this subcommand, you must have **CMC Login User** privilege.

**Description**

Displays network settings for a server, switch, or the chassis.



**NOTE:** The **getniccfg** subcommand will display an error message if the operation is not successful.

## Usage

```
racadm getniccfg [-m <module>]
```

## Options

Table A-16 describes the `getniccfg` subcommand options.

**Table A-16. getniccfg Subcommand Options**

Option	Description
-m <module>	Specifies the module whose network settings you want to view. <module> may be any of the following: <ul style="list-style-type: none"><li>• chassis</li><li>• server-<i>n</i> where <i>n</i>=1-16</li><li>• switch-<i>n</i> where <i>n</i>=1-6</li></ul> Default: chassis

## Examples

```
racadm getniccfg
```

```
NIC Enabled           = 1
DHCP Enabled          = 1
Static IP Address      = 192.168.0.120
Static Subnet Mask     = 255.255.255.0
Static Gateway         = 192.168.0.1
Current IP Address     = 10.35.155.160
Current Subnet Mask    = 255.255.255.0
Current Gateway        = 10.35.155.1
Speed                  = Autonegotiate
Duplex                 = Autonegotiate
```

- ```
racadm getniccfg -m server-1
DHCP Enabled          = 0
IP Address             = 192.168.0.135
Subnet Mask            = 255.255.255.0
Gateway                = 192.168.0.1
```

# getpbinfo

 **NOTE:** To use this subcommand, you must have **CMC Login User** privilege.

## Description

Displays power budget status information.

## Usage

```
racadm getpbinfo
```

## Example

```
racadm getpbinfo

[Power Budget Status]
Actual System AC Power Consumption           =
  532 watts
Peak System Power Consumption                =
  2492 watts
Peak System Power Consumption Timestamp      =
  01:08:23 11/27/2007
Minimum System Power Consumption            =
  316 watts
Minimum System Power Consumption Timestamp   =
  20:18:30 11/27/2007
Overall Power Health                         = OK
Redundancy                                   = No
System Max AC Power Limit                    =
  6657 watts
System AC Power Warning Threshold            =
  5991 watts
Server Power Throttling Enabled              = Yes
Redundancy Policy                            = None
Dynamic PSU Engagement Enabled                = No
System DC Max Power Capacity                 =
  6657 watts
DC Redundancy Reserve                         =
  0 watts
```

```

DC Power Allocated to Servers                =
  1315 watts
DC Power Allocated to Chassis Infrastructure  =
  1439 watts
Total DC Power Available for Allocation      =
  4326 watts
Standby DC Power Capacity                   =
  0 watts

```

[Chassis Power Supply Status Table]

| <Name> | <Presence>  | <Power State> | <Capacity> |
|--------|-------------|---------------|------------|
| PS1    | Present     | Online        | 2360 watts |
| PS2    | Present     | Online        | 2360 watts |
| PS3    | Present     | Online        | 2360 watts |
| PS4    | Not Present | Slot Empty    | N/A        |
| PS5    | Present     | Failed(No AC) | 2360 watts |
| PS6    | Not Present | Slot Empty    | N/A        |

[Server Module Power Allocation Table]

| <Slot#> | <Server Name>   | <PowerState> | <Allocation> | <Priority> | <Blade Type>    |
|---------|-----------------|--------------|--------------|------------|-----------------|
| 1       | SLOT-0101234567 | OFF          | 0 watts      | 5          |                 |
| 2       | SLOT-02         | OFF          | 0 watts      | 5          |                 |
| 3       | SLOT-03         | N/A          | N/A          | 5          | N/A             |
| 4       | SLOT-04         | ON           | 203 watts    | 5          |                 |
| 5       | SLOT-05         | ON           | 205 watts    | 5          | PowerEdgeM605   |
| 6       | SLOT-06         | N/A          | N/A          | 5          | N/A             |
| 7       | SLOT-07         | ON           | 300 watts    | 5          |                 |
| 8       | SLOT-08         | ON           | 180 watts    | 5          | PowerEdgeM600   |
| 9       | SLOT-09         | N/A          | N/A          | 5          | N/A             |
| 10      | SLOT-10         | N/A          | N/A          | 5          | N/A             |
| 11      | SLOT-11         | N/A          | N/A          | 5          | N/A             |
| 12      | SLOT-12         | ON           | 229 watts    | 5          |                 |
| 13      | SLOT-13         | N/A          | N/A          | 5          | N/A             |
| 14      | SLOT-14         | N/A          | N/A          | 5          | N/A             |
| 15      | SLOT-15         | ON           | 198 watts    | 5          | Power Edge M600 |
| 16      | SLOT-16         | N/A          | N/A          | 5          | N/A             |



# getraclog

 **NOTE:** To use this subcommand, you must have **CMC Login User** privilege.

## Description

Displays the CMC log entries. The timestamp begins at midnight, January 1 and increases until the system boots. After the system boots, the system's timestamp is used.

## Usage

```
racadm getraclog [-i]
racadm getraclog [-s <start record>] [-c <count>]
[-m]
```

## Options

Table A-17 describes the **getraclog** subcommand options.

**Table A-17. getraclog Subcommand Options**

| Open              | Description                                                                                                                             |
|-------------------|-----------------------------------------------------------------------------------------------------------------------------------------|
| (none)            | Displays the entire CMC log, including the record number, time stamp, source, and description of each event.                            |
| -s <start record> | Specifies the starting record used for the display                                                                                      |
| -c <count>        | Specifies the maximum number of entries to be returned.                                                                                 |
| -i                | Displays the number of entries in the CMC log.                                                                                          |
| -m                | Displays one screen of information at a time and prompts the user to continue to next screen (similar to the UNIX <b>more</b> command). |

## Examples

- ```
racadm getraclog -c 5
Apr 21 10:17:46 cmc : CMC1: active
Apr 21 10:17:46 cmc : CMC1: AC power up
Apr 21 10:17:48 cmc : CMC1: non redundant
Apr 21 12:17:48 cmc : Login success (username =
root)
```

```
Apr 23 23:59:11 cmc : session close PID 3291
succeeds
```

- `racadm getraclog -i`  
Total Records: 171

## getractive

 **NOTE:** To use this subcommand, you must have **CMC Login User** privilege.

### Description

Displays the date and time as currently set on the CMC.

### Usage

```
racadm getractive [-d] [-z]
```

### Options

Table A-18 describes the **getractive** subcommand options.

**Table A-18. getractive Subcommand Options**

Option	Description
(None)	Displays the date and time using the UTC hexadecimal value followed by the offset in signed decimal (default).
-d	Displays the date and time using the same format as the UNIX <sup>®</sup> <b>date</b> command (yyyymmddhhmmss.mmmmmmmsoff).
-z	Displays the time zone. For example, PST8PDT (Western United States), 279 (Seoul), 329 (Sydney).  To see a list of time zones, type: <code>racadm setractive -z *</code>

### Examples

- `racadm getractive`  
Thu Dec 8 20:15:26 2005
- `racadm getractive -z`  
Thu Dec 8 20:15:29 2006 CST6CDT

- `racadm gettractime -d`  
`0051208201542.000000`

## getredundancymode

 **NOTE:** To use this subcommand, you must have **CMC Login User** privilege.

### Description

Displays the redundancy status (Redundant or Non-Redundant) of the CMC.

### Usage

```
racadm getredundancymode
```

### Example

```
racadm getredundancymode
```

```
Redundant
```

## getsel

 **NOTE:** To use this subcommand, you must have **CMC Login User** privilege.

### Description

Displays the system event log (SEL, also called the hardware log) entries. The default output display shows the record number, timestamp, severity, and description of each event.

### Usage

```
racadm getsel [-i]
```

```
racadm getsel [-s <start record>] [-c <count>] [-m]
```

## Options

Table A-19 describes the `getsel` subcommand options.

**Table A-19. `getsel` Subcommand Options**

Option	Description
<code>-s &lt;start record&gt;</code>	Specifies the starting record used for the display
<code>-c &lt;count&gt;</code>	Provides the maximum count of entries to be returned.
<code>-i</code>	Displays the number of entries in the CMC log.
<code>-m</code>	Displays one screen of information at a time and prompts the user to continue to next screen (similar to the UNIX <code>more</code> command).

## Example

- ```
racadm getsel -i
Total Records: 28
```
- ```
racadm getsel -s 1 -c 1
Sun Sep 16 02:51:11 2007 normal Server Blade 12
Presence module sensor for Server Blade, device
inserted was asserted
```

## getsensorinfo



**NOTE:** To use this subcommand, you must have **CMC Login User** privilege.

## Description

Displays status for the specified sensors.

## Usage

```
racadm getsensorinfo
```

## Examples

```
racadm getsensorinfo
```

<senType>	<Num>	<sensorName>	<status>	<reading>	<units>	<lc>	<uc>
FanSpeed	1	Fan-1	OK	4768	rpm	2344	14500
FanSpeed	2	Fan-2	OK	4873	rpm	2344	14500
FanSpeed	3	Fan-3	OK	4832	rpm	2344	14500
FanSpeed	4	Fan-4	OK	4704	rpm	2344	14500
FanSpeed	5	Fan-5	OK	4833	rpm	2344	14500
FanSpeed	6	Fan-6	OK	4829	rpm	2344	14500
FanSpeed	7	Fan-7	OK	4719	rpm	2344	14500
FanSpeed	8	Fan-8	Not OK	1	rpm	2344	14500
FanSpeed	9	Fan-9	OK	4815	rpm	2344	14500

<senType>	<Num>	<sensorName>	<status>	<reading>	<units>	<lc>	<uc>
Temp	1	Ambient_Temp	OK	22	celcius	N/A	40

<senType>	<Num>	<sensorName>	<status>	<AC-OK status>
PWR	1	PS-1	Online	OK
PWR	2	PS-2	Online	OK
PWR	3	PS-3	Online	OK
PWR	4	PS-4	Slot Empty	N/A
PWR	5	PS-5	Failed	OK
PWR	6	PS-6	Slot Empty	N/A

## getslotname



**NOTE:** To use this subcommand, you must have **CMC Login User** privilege.

### Description

Displays the name of a specified slot (indicated by slot number) in the chassis.

### Usage

```
racadm getslotname -i <slot ID>
```

### Options

Table A-20 describes the **getslotname** subcommand options.

**Table A-20. getslotname Subcommand Options**

Option	Description
-i <slot ID>	Specifies the ID of the slot. <b>Legal values:</b> 1-16

**Example**

```
racadm getslotname -i 1  
Webserver-1
```

## getssninfo

 **NOTE:** To use this subcommand, you must have **CMC Login User** privilege.

**Description**

Displays information about an active user session, including user name, IP address (if applicable), and session type (for example, serial, SSH, or Telnet), and login date and time. Options allow you to view a list of currently active or pending users and summary session table information. The summary information provides the total number of sessions in each defined Session Manager state:

- Valid
- Available

**Usage**

```
racadm getssninfo [-u <username> | *] [-A]
```

**Options**

Table A-21 describes the getssninfo subcommand options.

**Table A-21. getssninfo Subcommand Options**

Option	Description
-u <username>	Limits the printed output to detailed session records for the specified user.
-u *	If an asterisk (*) is given as the user name, all users are listed. Summary information is not displayed when this option is specified.
-A	Suppresses headers and labels in the output.

### Examples

- racadm getssninfo

```
Type           User           IP Address
Login Date/Time
SSH            root           10.9.72.252
 11/28/2007 23:13:32
KVM            root           169.254.31.30
 11/28/2007 18:44:51
SSH            root           10.9.72.252
 11/28/2007 23:22:37
```

- racadm getssninfo -A

```
\Telnet\root\143.166.174.19\05/01/2007 02:13:59
```

- racadm getssninfo -A -u \*

```
\KVM\root\169.254.31.30\11/28/2007 18:44:51
\SSH\root\10.9.72.252\11/28/2007 23:22:37
```

## getsvctag



**NOTE:** To use this subcommand, you must have **CMC Login User** privilege.

## Description

Displays the service tag information, if present, for one or all modules on the chassis.

## Usage

```
racadm getsvctag [-m <module>]
```

## Options

Table A-22 describes the `getsvctag` subcommand options.

**Table A-22. getsvctag Subcommand Options**

Option	Description
(none)	Displays service tags for all modules on the chassis (including the chassis).
-m <module>	Displays the service tag for the specified module. <module> may be one of the following: <ul style="list-style-type: none"><li>• server-<i>n</i> where <i>n</i>=1-16</li><li>• switch-<i>n</i> where <i>n</i>=1-6</li><li>• chassis</li></ul>

## Examples

- ```
racadm getsvctag
<module>          <Servicetag>
Chassis
switch-1          ABC1234
switch-2
switch-3
switch-4
switch-5
switch-6
server-1
server-2
server-3          N/A
server-4
server-5
```



```

server-6          N/A
server-7          0000014
server-8
server-9          N/A
server-10         N/A
server-11         N/A
server-12
server-13         N/A
server-14
server-15         1234567
server-16         N/A

```

- `racadm getsvctag -m switch-1`  
`<module>`            `<Servicetag>`  
`switch-1`            `ABC1234`

## getsysinfo



**NOTE:** To use this subcommand, you must have **CMC Login User** privilege.

### Description

Displays information related to the CMC.

### Usage

```
racadm getsysinfo [-d] [-c] [-A]
```

### Options

**Table A-23. getsysinfo Subcommand Options**

| Option | Description                                  |
|--------|----------------------------------------------|
| -d     | Displays CMC information.                    |
| -c     | Displays chassis information.                |
| -A     | Suppresses headers and labels in the output. |

## Example

- `racadm getsysinfo -c`  
CMC Information:  
CMC Date/Time =  
Tue, 01 May 2007 02:33:47  
Primary CMC Version = 1.3 (Build 06.12)  
Standby CMC Version =  
Last Firmware Update =  
Thu, 01 May 2007 02:12:43  
Hardware Version = 15  
Current IP Address = 143.166.152.39  
Current IP Gateway = 143.166.152.1  
Current IP Netmask = 255.255.255.0  
DHCP enabled = 1  
MAC Address = 00:11:43:FD:B4:39  
Current DNS Server 1 = 0.0.0.0  
Current DNS Server 2 = 0.0.0.0  
DNS Servers from DHCP = 0  
Register DNS CMC Name = 1  
DNS CMC Name = cmc-51186  
Current DNS Domain =
- `racadm getsysinfo -A`  
"CMC Information:"  
"Tue, 01 May 2007 02:33:47 AM"  
"1.3 (Build 06.12)" " " "Thu, 01 May 2007 02:12:43"  
"15" "143.166.152.39" "143.166.152.1"  
"255.255.255.0" "1" "00:11:43:FD:B4:39" "0.0.0.0"  
"0.0.0.0" "0" "1" "cmc-51186" " "

## gettracelog



**NOTE:** This command is for Dell internal use only.



**NOTE:** To use this subcommand, you must have **CMC Login User** privilege.

## Description

Displays the diagnostic trace log for the CMC. The default output display shows the record number, timestamp, source, and description. The timestamp begins at midnight, January 1 and increases until the system boots. During system boot, the timestamp displays as `<system boot>`. After the system boots, the system's timestamp is used.

## Usage

```
racadm gettracelog [-i]
```

```
racadm gettracelog [-s <start record>] [-c <count>]  
[-m]
```

## Options

Table A-24 describes the `gettracelog` subcommand options.

**Table A-24. gettracelog Subcommand Options**

| Option | Description                                                                                                                                   |
|--------|-----------------------------------------------------------------------------------------------------------------------------------------------|
| (none) | Displays the CMC trace log.                                                                                                                   |
| -s     | Specifies the starting record to display.                                                                                                     |
| -c     | Specifies the number of records to display.                                                                                                   |
| -i     | Displays the number of entries in the CMC trace log.                                                                                          |
| -m     | Displays one screen of information at a time and prompts the user to continue to next screen (similar to the UNIX <code>more</code> command). |

## Example

- ```
racadm gettracelog -c 5  
Nov 28 04:40:41 cmc syslogd 1.4.1: restart.  
Nov 28 04:40:41 cmc fupmuxd[150]: Start Status Op:  
priv=0x00000000 ID:[01 01 0x00]  
Nov 28 04:40:41 cmc fupmuxd[150]: Active-CMC  
Status: 0x04000000  
Nov 28 04:40:52 cmc webcgi[28776]: postFWUpload:
```

```
rc = 10, file size = 0
Nov 28 04:40:52 cmc fupmuxd[150]: Start Status Op:
priv=0x00000000 ID:[01 01 0x00]
```

- `racadm gettracelog -i`  
Total Records: 275

## help and help <command>

 **NOTE:** To use this subcommand, you must have **CMC Login User** privilege.

### Description

The `help` command lists all of the subcommands you can use with the `racadm` command and a one-line description of each subcommand.

`help <command>` displays the syntax for the specified command.

 **NOTE:** You can also use the `?` and `? <command>` commands to obtain the same information.

### Usage

```
racadm help
```

```
racadm help <subcommand>
```

### Examples

- `racadm help getsysinfo`  
`getsysinfo -- display general CMC and system information`

Usage:

```
racadm getsysinfo [-d] [-c] [-A]
```

```
-d : show CMC information
-c : show chassis information
-A : do not show headers or labels
```

## ifconfig



**NOTE:** To use this subcommand, you must have **Administrator** privilege.

### Description

Display network interface information.

### Usage

```
racadm ifconfig
```

### Examples

```
racadm ifconfig
```

```
eth0      Link encap:Ethernet  HWaddr 00:55:AB:39:10:
0F
          inet addr:10.35.155.160  Bcast:10.35.155.25
5  Mask:255.255.255.0
          UP BROADCAST RUNNING MULTICAST  MTU:1500  M
etric:1
          RX packets:457405  errors:0  dropped:0  overru
ns:0  frame:0
          TX packets:16321  errors:0  dropped:0  overrun
s:0  carrier:0
          collisions:0 txqueuelen:0
          RX bytes:51383270 (49.0 MiB)  TX bytes:6573
645 (6.2 MiB)
```

## netstat



**NOTE:** To use this subcommand, you must have **Administrator** privilege.

### Description

Display routing table and network statistics.

### Usage

```
racadm netstat
```

## Examples

```
racadm netstat
```

```
Kernel IP routing table
```

Destination	Gateway	Genmask	Flags
MSS Window	irrtt Iface		
10.35.155.0	*	255.255.255.0	U
0 0	0 eth0		
default	10.35.155.1	0.0.0.0	UG
0 0	0 eth0		

## ping



**NOTE:** To use this subcommand, you must have Administrator privilege.

### Description

Send ICMP echo packets to a destination on the network.

### Usage

```
racadm ping <IP address>
```

### Examples

```
racadm ping 10.9.72.252
```

```
PING 10.9.72.252 (10.9.72.252): 56 data bytes
64 bytes from 10.9.72.252: icmp_seq=0 ttl=121 time=2.9
ms
```

```
--- 10.9.72.252 ping statistics ---
1 packets transmitted, 1 packets received, 0 percent
packet loss
round-trip min/avg/max = 2.9/2.9/2.9 ms
```

## racdump



**NOTE:** To use this subcommand, you must have Administrator privilege.

## Description

Displays diagnostic information for the CMC.

## Usage

```
racadm racdump
```

## Example

```
racadm racdump
```

```
=====
=====
General System/RAC Information
=====
=====

CMC Information:
CMC Date/Time           =
  Wed, 28 Nov 2007 11:55:49 PM
Primary CMC Version     = X08
Standby CMC Version     = N/A
Last Firmware Update    = Wed Nov 21 21:37:56 2007
Hardware Version        = 2
Current IP Address      = 10.35.155.160
Current IP Gateway      = 10.35.155.1
Current IP Netmask      = 255.255.255.0
DHCP Enabled            = 1
MAC Address             = 00:55:AB:39:10:0F
Current DNS Server 1    = 0.0.0.0
Current DNS Server 2    = 0.0.0.0
DNS Servers from DHCP   = 0
Register DNS CMC Name   = 0
DNS CMC Name            = cmc-servicetag
Current DNS Domain      =

Chassis Information:
System Model             = PowerEdgeM1000eControlPanel
System AssetTag         = 00000
```

```

Service Tag          =
Chassis Name        = Dell Rack System
Chassis Location     = [UNDEFINED]
Power Status        = ON

```

```

=====
=====
Session Information
=====
=====

```

Type	User	IP Address	Login Date/Time
SSH	root	10.9.72.252	11/28/2007 23:40:53
KVM	root	169.254.31.30	11/28/2007 18:44:51

```

=====
=====
Sensor Information
=====
=====

```

<senType>	<Num>	<sensorName>	<status>	<reading>	<units>	<lc>	<uc>
FanSpeed	1	Fan-1	OK	14495	rpm	7250	14500
FanSpeed	2	Fan-2	OK	14505	rpm	7250	14500
FanSpeed	3	Fan-3	OK	4839	rpm	2344	14500
FanSpeed	4	Fan-4	OK	14527	rpm	7250	14500
FanSpeed	5	Fan-5	OK	14505	rpm	7250	14500
FanSpeed	6	Fan-6	OK	4835	rpm	2344	14500
FanSpeed	7	Fan-7	OK	14521	rpm	7250	14500
FanSpeed	8	Fan-8	Not OK	1	rpm	7250	14500
FanSpeed	9	Fan-9	OK	4826	rpm	2344	14500

<senType>	<Num>	<sensorName>	<status>	<reading>	<units>	<lc>	<uc>
Temp	1	Ambient_Temp	OK	21	celcius	N/A	40

```

<senType> <Num> <sensorName> <status> <AC-OK status>

```



PWR	1	PS-1	Online	OK
PWR	2	PS-2	Online	OK
PWR	3	PS-3	Online	OK
PWR	4	PS-4	Slot Empty	N/A
PWR	5	PS-5	Failed	OK
PWR	6	PS-6	Slot Empty	N/A

## racreset



**NOTE:** To use this subcommand, you must have **Administrator** privilege.

### Description

Issues a soft or hard reset to the CMC. The reset event is written into the CMC log. When this command is executed without the **hard** option, **racreset** executes a soft reset. A hard reset performs a deep reset operation on the CMC. A hard reset should only be performed as a last-case resort to recover the CMC.



**NOTICE:** You must reboot your system after performing a hard reset of the CMC. See "racreset" on page 329.



**NOTICE:** When you issue a **racreset** subcommand, the CMC may require up to one minute to return to a usable state.

### Usage

```
racadm racreset [hard | soft]
```

### Options

Table A-25 describes the **racreset** subcommand options.

**Table A-25. racreset Subcommand Options**

Option	Description
hard	A <i>hard</i> reset performs a deep reset operation on the remote access controller. A hard reset should only be used as a last-case resort for CMC recovery purposes.
soft	A <i>soft</i> reset performs a graceful reboot operation on the CMC.

## Example

- `racadm racreset`  
Executes a soft reset sequence on the CMC.
- `racadm racreset soft`  
Executes a soft reset sequence on the CMC.
- `racadm racreset hard`  
Executes a hard reset sequence on the CMC.

## racresetcfg



**NOTE:** To use this subcommand, you must have **Administrator** privilege.



**NOTE:** Power off the chassis before running this command.

### Description

Removes all database property entries on the CMC or iKVM and restores the default factory configuration. After restoring the database properties, the CMC resets automatically. The iKVM also resets automatically when `racresetcfg` is used to restore its default properties.



**NOTICE:** This command deletes your current CMC configuration and resets the CMC and serial configuration to the original default settings. After reset, the default name and password are `root` and `calvin`, respectively, and the IP address is `192.168.0.120`. If you issue `racresetcfg` from a network client (for example, a supported Web browser or Telnet/SSH), you must use the default IP address.

### Usage

```
racadm racresetcfg [-m <module>]
```

### Options

Table A-26 describes the `racresetcfg` subcommand options.

**Table A-26. racreset Subcommand Options**

Option	Description
-m <i>&lt;module&gt;</i>	Specifies the module whose database properties you want to reset. <i>&lt;module&gt;</i> may be any of the following: <ul style="list-style-type: none"><li>• chassis</li><li>• kvm</li></ul> Default: chassis

### Example

```
racadm racresetcfg -m kvm
```

The configuration has initiated restoration to factory defaults.

## serveraction



**NOTE:** To use this subcommand, you must have **Administrator** privilege.

### Description

Executes a server reset, power-up, power-down, or powercycle on the specified server.

### Usage

```
racadm serveraction -m server-n <action>
```

### Options

Table A-27 describes the `serveraction` subcommand options.

**Table A-27. serveraction Subcommand Options**

Option	Description
-m server- <i>n</i>	Specifies the server by its slot number (1–16) in the chassis. For example, server-2.

**Table A-27. serveraction Subcommand Options (continued)**

Option	Description
<code>&lt;action&gt;</code>	Specifies the action. <code>&lt;action&gt;</code> may be one of the following: <ul style="list-style-type: none"><li>• <code>powerdown</code> — Powers down the server.</li><li>• <code>powerup</code> — Powers up the server.</li><li>• <code>powercycle</code> — Issues a power-cycle operation on the server. The <code>-w &lt;cycleWait&gt;</code> option can be used with <code>powercycle</code>.</li><li>• <code>graceshutdown</code> — Shuts down the server gracefully.</li><li>• <code>hardreset</code> — Performs a reset (reboot) operation on the server.</li><li>• <code>powerstatus</code> — Displays current power status (Online, Off) of the server.</li></ul>

**Example**

```
racadm serveraction -m server-3 powerup
Server power operation successful.
```

## setchassisname



**NOTE:** To use this subcommand, you must have **Administrator** privilege.

**Description**

Sets the name of the chassis in the LCD.

**Usage**

```
racadm setchassisname <name>
```

**Example**

```
racadm setchassisname dellchassis-1
The chassis name was set successfully.
```

# setassettag

 **NOTE:** To use this subcommand, you must have Administrator privilege.

## Description

Sets the N-byte ASCII asset tag for the chassis.

## Usage

```
racadm setassettag -m chassis <asset tag>
```

## Options

Table A-28 describes the `setassettag` subcommand options.

**Table A-28. setassettag Subcommand Options**

Option	Command
<code>-m &lt;module&gt;</code>	Specifies the module whose asset tag you want to set. Legal value: <code>chassis</code> <b>NOTE:</b> Because there is only one legal value, you can obtain the same output if you do not include this option.

## Example

Input:

```
racadm setassettag -m chassis 783839-33
```

or

```
racadm setassettag 783839-33
```

The asset tag was changed successfully.

# setflexaddr

 **NOTE:** To use this subcommand, you must have Chassis Configuration Administrator privilege.

## Description

Enables/disables FlexAddress on a particular slot/fabric.

 **NOTE:** If the fabric type is determined to be Infiniband, the operation is canceled and the command returns an error. If the FlexAddress feature is not activated, the command will return an error.

 **NOTE:** The server must be powered off to change the slot state. All servers must be powered off to change the fabric state.

## Usage

```
racadm setflexaddr [-i <slot#> <state>]  
[-f <fabricName> <state>]
```

<slot#> = 1 to 16

<fabricName> = A, B, C

<state> = 0 or 1

where 0 is disable and 1 is enable

## Options

Table A-29 describes the `setflexaddr` subcommand options.

**Table A-29. setflexaddr Subcommand Options**

Option	Description
<code>-i &lt;slot#&gt;</code> <code>&lt;state&gt;</code>	Enables/disables FlexAddress for the specified slot.
<code>-f</code> <code>&lt;fabricName&gt;</code> <code>&lt;state&gt;</code>	Enables/disables FlexAddress for the specified fabric.

## Example

- `racadm setflexaddr -i 1 0`  
Slot 1 FlexAddress state set successfully
- `racadm setflexaddr -f A 1`  
Fabric A FlexAddress state set successfully

# setled

 **NOTE:** To use this subcommand, you must have **Administrator** privilege.

## Description

Sets the state (blinking or not blinking) of the LED on the specified module.

## Usage

```
racadm setled -m <module> -l <ledState>
```

## Options

Table A-30 describes the **setled** subcommand options.

**Table A-30. setled Subcommand Options**

Option	Description
-m <module>	Specifies the module whose LED you want to configure. <module> can be one of the following: <ul style="list-style-type: none"><li>• server-<i>n</i> where <i>n</i>=1-16</li><li>• switch-<i>n</i> where <i>n</i>=1-6</li><li>• cmc-active</li><li>• chassis</li></ul>
-l <ledstate>	Specifies whether the LED should blink. <ledstate> can be one of the following: <ul style="list-style-type: none"><li>• 0 — no blinking</li><li>• 1 — blinking</li></ul>

## Example

```
racadm setled -m server-3 -l 1
```

LED state was set successfully.

# setnicfg

 **NOTE:** To use this subcommand, you must have **Administrator** privilege.

## Description

Sets the IP configuration for the specified module.

## Usage

```
racadm setniccfg [-m <module>] [-d] [-o] [-s  
<ipaddress> <subnetmask> <gateway>] [-k <speed>  
<duplex>]
```

```
racadm setniccfg [-m <module>] -d
```

```
racadm setniccfg [-m <module>] -s <ipAddress>  
<netmask> <gateway>
```

```
racadm setniccfg [-m <module>] -o
```

```
racadm setniccfg [-m <module>] -k [<speed> <duplex>]
```

## Options

Table A-31 describes the `setniccfg` subcommand options.

**Table A-31. setniccfg Subcommand Options**

Option	Description
-m <module>	Specifies the module for which you want to set the IP configuration.  <module> can be any of the following: <ul style="list-style-type: none"><li>• server-<i>n</i> where <i>n</i>=1-16</li><li>• switch-<i>n</i> where <i>n</i>=1-6</li><li>• chassis</li></ul> If the <b>-m</b> option is excluded, the module defaults to <code>chassis</code> .
-d	Enables DHCP for the Ethernet management port (default is DHCP enabled).
-s	Enables static IP settings by specifying the IP address, subnet mask, and gateway. <ipAddress>, <netmask>, and <gateway> must be typed as dot-separated strings.  If this option is not supplied, the existing static settings are used.



**Table A-31. setniccfg Subcommand Options (continued)**

Option	Description
-o	Disables the Ethernet management port completely.
-k	Specifies the speed and duplex for the NIC. <ul style="list-style-type: none"><li>• Speed: 10, 100, 1000</li><li>• Duplex: half, full</li><li>• (no value supplied): Autonegotiate</li></ul>

### Examples

- ```
racadm setniccfg -s 143.166.152.39 143.166.152.1  
255.255.255.0  
OK
```
- ```
racadm setniccfg -k 100 full  
Speed and Duplex settings modified successfully.
```

## setractime



**NOTE:** To use this subcommand, you must have **Administrator** privilege.

### Description

Sets the date and time on the CMC.

### Usage

```
racadm setractime -d <yyyymmddhhmmss.mmmmmmsoff>  
racadm setractime -l <yyyymmddhhmmss> [-z <zone>]
```

### Options

Table A-32 describes the **setractime** subcommand options.

**Table A-32. setractive Subcommand Options**

<b>Option</b>	<b>Description</b>
-d	Sets the time in the string <i>yyyymmddhhmmss.mmmmmmmsoff</i> where: <ul style="list-style-type: none"><li>• <i>yyyy</i> is a year</li><li>• <i>mm</i> is the month</li><li>• <i>dd</i> is the day</li><li>• <i>hh</i> is the hour</li><li>• <i>mm</i> is the minutes</li><li>• <i>ss</i> is the seconds</li><li>• <i>mmmmmm</i> is the number of microseconds</li><li>• <i>s</i> is a + (plus) sign or a - (minus) sign, which indicates the sign of the offset</li><li>• <i>off</i> is the offset in minutes</li></ul> <p><b>NOTE:</b> The <i>off</i> is the offset in minutes from GMT and must be in 15-minute increments.</p>
-z <zone>	Sets the time zone. For example, PST8PDT (Western United States), 279 (Seoul), 329 (Sydney).  To see a list of time zones, type: <pre>racadm setractive -z *</pre>
-l	Sets the local date and time in the string <i>yyyymmddhhmmss</i> where: <ul style="list-style-type: none"><li>• <i>yyyy</i> is a year</li><li>• <i>mm</i> is the month</li><li>• <i>dd</i> is the day</li><li>• <i>hh</i> is the hour</li><li>• <i>mm</i> is the minute</li><li>• <i>ss</i> is the second</li></ul> <p>This property allows for differences in time due to Daylight Saving Time.</p>

## Example

The `setractime` subcommand supports dates ranging from 1/1/1970 00:00:00 through 12/31/2030 23:59:59. To set the date to October 24, 2007 at 3:02:30 PM PST:

```
racadm setractime -l 20071024150230 -z PST8PDT
```

The time was set successfully.

## setslotname



**NOTE:** To use this subcommand, you must have Administrator privilege.



**NOTE:** See "Editing Slot Names" on page 91 for rules for selecting slot names.

### Description

Sets the name of a slot in the chassis.

### Usage

```
racadm setslotname -i <slotID> <slotname>
```

### Options

Table A-33 describes the `setslotname` subcommand options.

**Table A-33. setslotname Subcommand Options**

Option	Description
<slotID>	Indicates the location of the slot in the chassis. Legal values: 1–16
<slotname>	The new name to assign to the slot.

### Example

```
racadm setslotname -i 3 mserver3
```

The slot name was set successfully.

# setsysinfo

 **NOTE:** To use this subcommand, you must have Administrator privilege.

## Description

Sets the name or location of the chassis.

## Usage

```
racadm setsysinfo [-c chassisname|chassislocation]
<string>
```

## Option

Table A-34 describes the `setsysinfo` subcommand options.

**Table A-34. setsysinfo Subcommand Options**

Option	Description
<i>&lt;string&gt;</i>	Indicates the N-byte ASCII chassis name or location.

## Example

```
racadm setsysinfo -c chassisname "Dell Rack System"
```

The chassis name was set successfully.

# sslcertdownload

 **NOTE:** To use this subcommand, you must have Chassis Configuration Administrator privilege.

## Description

Downloads an SSL certificate from the RAC to the client's file system.

## Usage

```
racadm sslcertdownload -t <type> -f <filename>
```

## Options

Table A-35 describes the `sslcertdownload` subcommand options.

**Table A-35. sslcertdownload Subcommand Options**

Option	Description
-t	Specifies the type of certificate you want to download: 1 — server certificate 2 — Microsoft Active Directory certificate
-f	Specifies the local file path and file name where you want to save the certificate.

## Restrictions

The `sslcertdownload` subcommand can only be executed from a remote client.

## Example

```
racadm sslcertdownload -t 1 -f c:\cert\cert.txt
```

Certificate successfully downloaded from the CMC.

# sslcertupload



**NOTE:** To use this subcommand, you must have **Chassis Configuration Administrator** privilege.

## Description

Uploads a custom SSL server or certificate authority-signed certificate from the client to the CMC.

## Usage

```
racadm sslcertupload -t <type> -f <filename>
```

## Options

Table A-36 describes the **sslcertupload** subcommand options.

**Table A-36. sslcertupload Subcommand Options**

Option	Description
-t <type>	Specifies the type of certificate to upload: 1 — Server certificate 2 — Certificate authority-signed certificate
-f <filename>	Specifies the file name of the certificate to be uploaded.

## Restrictions

The **sslcertupload** subcommand can only be executed from a local client.

## Example

```
racadm sslcertupload -t 1 -f c:\cert\cert.txt
```

Certificate successfully uploaded to the CMC.

# sslcertview



**NOTE:** To use this subcommand, you must have **Administrator** privilege.

## Description

Displays the SSL server or certificate authority-signed certificate that exists on the CMC.

## Usage

```
racadm sslcertview -t <type> [-A]
```

## Options

Table A-37 describes the **sslcertview** subcommand options.

**Table A-37. sslcertview Subcommand Options**

Option	Description
-t <type>	Specifies the type of certificate to view, either the Microsoft Active Directory certificate or server certificate. 1 — server certificate 2 — Microsoft Active Directory certificate
-A	Suppresses headers and labels in the output.

**Restrictions**

The `sslcertupload` subcommand can only be executed from a local client.

**Examples**

```
racadm sslcertview -t 1
```

```
Serial Number           : 00
```

## Subject Information:

```
Country Code (CC)      : US
Locality (L)           : Round Rock
Organization (O)       : Dell Inc.
Organizational Unit (OU) : OpenCMC Group
Common Name (CN)       : CMCdefault
```

## Issuer Information:

```
Country Code (CC)      : US
Locality (L)           : Round Rock
Organization (O)       : Dell Inc.
Organizational Unit (OU) : OpenCMC Group
Common Name (CN)       : CMCdefault
```

```
Valid From             : Nov  6 01:23:03 2007 GMT
Valid To               : Nov  3 01:23:03 2017 GMT
```

# sslcsrgen

 **NOTE:** To use this subcommand, you must have **Chassis Configuration Administrator** privilege.

## Description

Generates and downloads an SSL certificate signing request (CSR) from the CMC to your management station or shared network. You can use the CSR to create a custom SSL certificate for transactions on the CMC.

## Usage

```
racadm sslcsrgen [-g]  
racadm sslcsrgen [-g] [-f <filename>]  
racadm sslcsrgen [-s]
```

## Options

Table A-38 describes the `sslcsrgen` subcommand options.

**Table A-38. sslcsrgen Subcommand Options**

Option	Description
-g	Generates a new CSR. The -g option cannot be used with the -s option.
-s	Returns the status of a CSR generation process: <ul style="list-style-type: none"><li>• CSR was generated successfully.</li><li>• CSR does not exist.</li><li>• CSR generation in progress.</li></ul> The -s option cannot be used with the -g option.
-f <filename>	Specifies the filename where the CSR will be downloaded. Can only be used with the -g option.

 **NOTE:** The -f option is not supported for the serial/Telnet/SSH console.

 **NOTE:** If no options are specified, a CSR is generated and downloaded to the local file system as `sslcsr` by default.



## Restrictions

The `sslcsrgen` subcommand can only be executed from a local client and cannot be used in the serial, Telnet, or SSH interface.

## Example

- `racadm sslcsrgen -s`  
CSR generation in progress.
- `racadm sslcsrgen -g -f c:\csr\csrtest.txt`  
The csr was generated successfully.

# testemail



**NOTE:** To use this subcommand, you must have **Test Alert User** privilege.

## Description

Sends a test e-mail from the CMC to a specified destination.



**NOTE:** This command is valid only if e-mail alerts are enabled on the CMC. For more information about e-mail alerts, see "Configuring E-mail Alerts" on page 265.

## Usage

```
racadm testemail -i <index>
```

## Option

Table A-39 describes the `testemail` subcommand options.

**Table A-39. testemail Subcommand Options**

Option	Description
-i <index>	Specifies the index of the e-mail alert to test.

## Example

```
racadm testemail -i 1
```

Test email sent successfully.

# testtrap

 **NOTE:** To use this subcommand, you must have **Test Alert User** privilege.

## Description

Tests the CMC SNMP trap alerting feature by sending a test trap from the CMC to a specified destination trap listener on the network.

 **NOTE:** This command is valid only if SNMP alerts are enabled on the CMC. For more information about SNMP alerts, see "Configuring SNMP Alerts" on page 260.

## Usage

```
racadm testtrap -i <index>
```

## Options

Table A-40 describes the **testtrap** subcommand options.

**Table A-40. testtrap Subcommand Options**

Option	Description
-i <index>	Specifies the index of the trap configuration to use for the test. Legal values: 1-4

## Example

```
racadm testtrap -i 4
```

Test trap sent successfully.

# B

## CMC Property Database Group and Object Definitions

The CMC property database contains the configuration information for the CMC. Data is organized by associated object, and objects are organized by object group. The IDs for the groups and objects that the property database supports are listed in this section.

Use the group and object IDs with the RACADM subcommands **config** (see "config" on page 290) and **getconfig** (see "getconfig" on page 299) to configure the CMC. The following sections describe each object and indicate whether the object is readable, writable, or both.

All string values are limited to displayable ASCII characters, except where otherwise noted.

### Displayable Characters

Displayable characters include the following set:

abcdefghijklmnopqrstuvwxyz

ABCDEFGHIJKLMNPOQRSTUVWXYZ

0123456789~`!@#\$%^&\*()\_+={ } [ ] | \ : " ; ' < > , . ? /

### idRacInfo (read only)



**NOTE:** Use this object with the **config** or **getconfig** subcommands.



**NOTE:** To use this object property, you must have **CMC Login User** privilege.

#### Description

Displays information for CMC properties. **Read only.**

## Synopsis

```
racadm getconfig -g idRacInfo
```

### #idRacType

Identifies the remote access controller type as the CMC.

### #idRacProductInfo

Uses a text string to identify the product, for example, Chassis Management Controller.

### #idRacDescriptionInfo

A text description of the RAC type.

### #idRacVersionInfo

A string containing the current product firmware version.

### #idRacBuildInfo

The current RAC firmware build version.

### #idRacName

A user-assigned name that identifies the CMC.

## Example

```
racadm getconfig -g idRacInfo
# idRacType=8
# idRacProductInfo=Chassis Management Controller
# idRacDescriptionInfo=This system component provides
a complete set of remote management functions for
blade servers
# idRacVersionInfo=P21
# idRacBuildInfo=200708301525
# idRacName=CMC-1
```

# cfgLanNetworking



**NOTE:** Use this object with the **config** or **getconfig** subcommands.



**NOTE:** To use this object property, you must have **Chassis Configuration Administrator** privilege.



**NOTE:** You can configure any setting that is not preceded by the hash sign (#) in the output. To modify a configurable object, use the **-o** option.

## Description

Displays information for and configures network related properties.

## Synopsis

```
racadm getconfig -g cfgLanNetworking
```

## cfgNicEnable

Enables or disables the CMC NIC. If this property is set to 0 (false), the remote network interfaces to the CMC are not accessible, and the CMC is available only through the serial RACADM interfaces.

- Configuration options: 1 (true), 0 (false)
- Default: 1

## cfgNicIpAddress

Assigns a static IP address to the CMC. This property is used only if **cfgNicUseDhcp** is set to 0 (false).

- Legal value: A string representing a valid IP address. For example, 192.168.0.20.

## cfgNicNetmask

Assigns a static subnet mask for the CMC IP address. This property is used only if **cfgNicUseDhcp** is set to 0 (false).

- Legal value: A string representing a valid subnet mask. For example, 255.255.255.0.

## cfgNicGateway

Assigns a static gateway for the CMC IP address. This property is used only if `cfgNicUseDhcp` is set to 0 (false).

- Legal value: A string representing a valid gateway. For example, 192.168.0.1.

## cfgDNSServersFromDHCP (Read/Write)



**NOTE:** To modify this property, you must have **Configure DRAC 5** permission.

Specifies that the DNS server IP addresses should be assigned from the DHCP server on the network.

- Configuration options: 1 (true), 0 (false)
- Default: 0

## cfgDNSServer1 (Read/Write)



**NOTE:** To modify this property, you must have **Configure DRAC 5** permission.

Specifies the DNS server 1 IP address. This property is only valid if `cfgDNSServersFromDHCP` is set to 0 (false).

- Configuration options: A string representing a valid IP address. For example: "192.168.0.20".



**NOTE:** `cfgDNSServer1` and `cfgDNSServer2` may be set to identical values while swapping addresses.

## cfgDNSServer2 (Read/Write)



**NOTE:** To modify this property, you must have **Configure DRAC 5** permission.

Retrieves DNS server 2 IP address. This parameter is only valid if `cfgDNSServersFromDHCP` is set to 0 (false).

- Configuration options: A string representing a valid IP address. For example: "192.168.0.20".
- Default: 0.0.0.0



**NOTE:** `cfgDNSServer1` and `cfgDNSServer2` may be set to identical values while swapping addresses.

## **cfgDNSRacName**

Displays the CMC name. This parameter is used only if **cfgDNSRegisterRac** is set to 1 (true).

- **Configuration options:** String of up to 63 alphanumeric characters and hyphens; must begin with a letter. For example: `cmc-1, d-345`.
- **Default:** `cmc-<service tag>`

## **cfgDNSDomainName**

Displays the DNS domain name. This parameter displays only if **cfgDNSDomainNameFromDHCP** is set to 0 (false).

- **Configuration options:** String of up to 254 alphanumeric characters and hyphens; *must begin with a letter*. For example: `p45, a-tz-1, rid-`.
- **Default:** `""`

## **cfgDNSDomainNameFromDHCP**

Specifies whether the CMC DNS domain name is assigned by the network DHCP server.

- **Configuration options:** 1 (true), 0 (false)
- **Default:** 0

## **cfgDNSRegisterRac**

Registers the CMC name on the DNS server.

- **Configuration options:** 1 (true), 0 (false)
- **Default:** 0

## **Example**

```
racadm getconfig -g cfgLanNetworking
cfgNicEnable=1
cfgNicIpAddress=192.168.22.101
cfgNicNetmask=255.255.255.0
cfgNicGateway=192.168.22.101
cfgNicUseDhcp=1
#cfgNicMacAddress=00:00:00:00:00:01
cfgDNSServersFromDHCP=0
```

```
cfgDNSServer1=192.168.0.5
cfgDNSServer2=192.168.0.6
cfgDNSRacName=d-345
cfgDNSDomainName=d-
cfgDNSDomainNameFromDHCP=0
cfgDNSRegisterRac=0
```

## cfgCurrentLanNetworking (read only)



**NOTE:** Use this object with the `getconfig` subcommand.

### Description

Displays the current CMC NIC properties.

### Synopsis

```
racadm getconfig [-g] [-o <object name>] [-i <index>]
[-h] cfgCurrentLanNetworking
racadm config [-g] [-o <object name>] [-i <index>]
[-h] cfgCurrentLanNetworking
```

### # cfgNicCurrentIpAddress

Displays the static IP address to the CMC.

### # cfgNicCurrentNetmask

Displays the static subnet mask for the CMC IP address.

### # cfgNicCurrentGateway

Displays the static gateway for the CMC IP address.

### # cfgNicCurrentDhcpWasUsed

Indicates whether DHCP is used to configure the NIC:

1 — address is static.

0 — address was obtained from the DHCP server.



### # **cfgDNSCurrentServer1**

Displays the IP address for DNS server 1.

### # **cfgDNSCurrentServer2**

Displays the IP address for DNS server 2.

### # **cfgDNSCurrentDomainName**

Displays the DNS domain name.

#### **Example**

```
racadm getconfig -g cfgCurrentLanNetworking
# cfgNicCurrentIpAddress=143.166.152.116
# cfgNicCurrentNetmask=255.255.255.0
# cfgNicCurrentGateway=143.166.152.1
# cfgNicCurrentDhcpWasUsed=0
# cfgDNSCurrentServer1=192.168.0.5
# cfgDNSCurrentServer2=192.168.0.6
# cfgDNSCurrentDomainName=MYDOMAIN
```

## **cfgRemoteHosts**



**NOTE:** Use this object with the **config** or **getconfig** subcommands.



**NOTE:** To use this object property, you must have **Chassis Configuration Administrator** privilege.

#### **Description**

Enables/disables and configures firmware updates and SMTP e-mail alerting.

### **cfgRhostsFwUpdateTftpEnable**

Enables or disables CMC firmware updates from a network TFTP server.

- Configuration options: 1 (true), 0 (false)
- Default: 1

## cfgRhostsFwUpdateIpAddr

The IP address of the network SMTP server. The SMTP server transmits e-mail alerts from the CMC (if the alerts are configured and enabled).

Configuration options: A string representing a valid SMTP server IP address. For example, 192.168.0.55.

Default: 0.0.0.0

## cfgRhostsFwUpdatePath

Specifies the TFTP path where the CMC firmware image file exists on the TFTP server. The TFTP path is relative to the TFTP root path on the TFTP server.



**NOTE:** The server may still require you to specify the drive (for example, C).

Legal value: String of up to 255 characters.

## cfgRhostsSmtServerIpAddr

Specifies the IP address of the network SMTP server, which transmits e-mail alerts from the CMC if the alerts are configured and enabled.

Legal value: A string representing a valid TFTP server IP address. For example, 192.168.0.55.

Default: 0.0.0.0

### Example

```
racadm getconfig -g cfgRemoteHosts
cfgRhostsFwUpdateTftpEnable=1
cfgRhostsFwUpdateIpAddr=127.0.0.1
cfgRhostsFwUpdatePath=m13_0417.bin
cfgRhostsSmtServerIpAddr=localhost.localdomain
```

## cfgUserAdmin



**NOTE:** In the current CMC firmware version, the objects **cfgUserAdminEnable** and **cfgUserAdminPrivilege** are interrelated; changing the value of one property causes the value of the other property to change. For example, if a user does not have login privilege, the user is disabled by default. When you enable the user by changing the

value of **UserAdminEnable** to 1, the right most digit of the **UserAdminPrivilege** will also become 1. On the other hand, if you change the right most digit of the **UserAdminPrivilege** to 0, the value of **UserAdminEnable** will become 0.



**NOTE:** Use this object with the **config** or **getconfig** subcommands.



**NOTE:** To use this object property, you must have **Chassis Configuration Administrator** privilege.



**NOTE:** You can configure any setting that is not preceded by the hash sign (#) in the output. To modify a configurable object, use the **-o** option.

## Description

Displays information for and configures CMC users.

### # **cfgUserAdminIndex**

Read only. Displays the index name.

### **cfgUserAdminEnable**

Enables or disables an individual user.

Configuration options: 1 (true), 0 (false)

Default: 0

### **cfgUserAdminUserName**

Displays/sets the name of the user for the specified index name. The user index is created by writing a string into this name field if the index is empty. Writing a string of double quotation marks ("" ) deletes the user at that index. To change the name, you must delete and then re-create the name. The string cannot contain "/" (forward slash), "\" (backslash), "." (period), "@" ("at") or quotations marks.

Legal value: String of up to 16 characters

### # **cfgUserAdminPassword**

Write only. Displays the password for this user index as a series of asterisks (\*). It cannot be seen or displayed after this property is written.

## cfgUserAdminPrivilege

Specifies the role-based authority privileges for the user. The value is represented as a bitmask that allows for any combination of privileges values. Table B-1 describes the allowed bit masks. Table B-2 provides sample privileges bit masks for users with one or more privileges.

**Configuration options:** 0x0000000–0x00001ff, and 0x0

**Default:** 0x0000000

### Example

```
racadm getconfig -g cfgUserAdmin -i 2

# cfgUserAdminIndex=1
cfgUserAdminEnable=1
cfgUserAdminUserName=root
# cfgUserAdminPassword=***** (Write-Only)
cfgUserAdminPrivilege=0x00000fff
```

**Table B-1. Bit Masks for User Privileges**

User Privilege	Privilege Bit Mask
CMC Login User	0x0000001
Chassis Configuration Administrator	0x0000002
User Configuration Administrator	0x0000004
Clear Logs Administrator	0x0000008
Chassis Control Administrator	0x0000010
Super User	0x0000020
Server Administrator	0x0000040
Test Alert User	0x0000080
Debug Command Administrator	0x0000100
Fabric A Administrator	0x0000200
Fabric B Administrator	0x0000400
Fabric C Administrator	0x0000800

**Table B-2. Sample Bit Masks for User Privileges**

User Privilege	Privilege Bit Mask
The user is not allowed to access the CMC.	0x00000000
The user can only log in to the CMC and view CMC and server configuration information.	0x00000001
The user can log in to and configure the CMC.	0x00000001 + 0x00000002 = 0x00000003

## cfgEmailAlert



**NOTE:** Use this object with the **config** or **getconfig** subcommands.



**NOTE:** To use this object property, you must have **Chassis Configuration Administrator** privileges.



**NOTE:** You can configure any setting that is not preceded by the hash sign (#) in the output. To modify a configurable object, use the **-o** option.

### Description

Configures CMC e-mail alerting.

### # cfgEmailAlertIndex

**Read only.** Displays the unique index of an alert instance. **Configuration range:** 1–4

**Default:** This parameter is populated based on the existing instances.

### cfgEmailAlertEnable

Enables or disables CMC e-mail alerting. **Configuration options:** 1 (enable), 0 (disable)

**Default:** 0 (disabled)

## # cfgEmailAlertAddress

Read only. Indicates the destination e-mail address for the e-mail alerts.

**Configuration options:** E-mail address format, with a maximum length of 64 ASCII characters.

**Default:** [null]

## cfgEmailAlertEmailName

Specifies the name or other identifier associated with the destination e-mail address. The e-mail name can refer to an individual, group, location, department, etc. **Configuration options:** String of up to 32 characters.

**Default:** [null]

### Example

```
racadm getconfig -g cfgEmailAlert -i 2
# cfgEmailAlertIndex=1
cfgEmailAlertEnable=1
cfgEmailAlertAddress=kfulton@dell.com
cfgEmailAlertName=Kevin Fulton
```

## cfgSessionManagement



**NOTE:** Use this object with the `config` or `getconfig` subcommands.



**NOTE:** To use this object property, you must have **Chassis Configuration Administrator** privilege.

### Description

Displays current settings for and configures idle timeout properties for Web server, Telnet, SSH, and RACADM sessions. Changes to idle timeout settings take effect at the next login. To disable idle timeout for a connection, set this property to 0.

## Objects

### **cfgSsnMgtWebserverTimeout**

Specifies the number of seconds after which an idle connection to the Web server is automatically terminated. **Configuration range:** 60–1920 seconds

**Default:** 300 seconds

### **cfgSsnMgtTelnetIdleTimeout**

Specifies the number of seconds after which an idle Telnet session is automatically terminated. **Configuration options:** 0 (no timeout); 60–1920 seconds

**Default:** 300 seconds

### **cfgSsnMgtSshIdleTimeout**

Specifies the number of seconds after which an idle Secure Shell session is automatically terminated. **Configuration options:** 0 (no timeout); 60–1920 seconds

**Default:** 300 seconds

### **cfgSsnMgtRacadmTimeout**

Specifies the number of seconds after which an idle remote RACADM connection is automatically terminated. **Configuration range:** 10–1920 seconds

**Default:** 30 seconds

### **Example**

```
racadm getconfig -g cfgSessionManagement  
cfgSsnMgtWebserverTimeout=0  
cfgSsnMgtTelnetIdleTimeout=0  
cfgSsnMgtSshIdleTimeout=300  
cfgSsnMgtRacadmTimeout=0
```

# cfgSerial



**NOTE:** Use this object with the **config** or **getconfig** subcommands.



**NOTE:** To use this object property, you must have **Chassis Configuration Administrator** privilege.

## Description

Displays information for and configures serial parameters.

## Objects

### cfgSerialBaudRate

Sets the baud rate on the CMC serial port.

**Configuration options:** 9600, 19200, 28800, 38400, 57600, 115200

**Default:** 115200

### cfgSerialConsoleEnable

Enables or disables the CMC serial console interface.

**Configuration options:** 1 (true), 0 (false)

**Default:** 1

### cfgSerialConsoleQuitKey

Specifies the key or key combination that terminates the serial text console. The value can be represented by one of the following:

- Decimal value — For example: 95
- Hexidecimal value — For example: 0x12
- Octal value — For example: 007
- ASCII value — For example: <Ctrl>a

ASCII values may be represented using the following Escape Key codes:

**a** <Ctrl> with any alphabetic character (a-z, A-Z)

**b** <Ctrl> with one of the following special characters: [ ] \ ^ \_

**Legal value:** String of up to 4 characters

**Default:** <Ctrl><\>



### **cfgSerialConsoleIdleTimeout**

The maximum number of seconds to wait before an idle serial session is disconnected.

**Configuration options:** 0 (no timeout), 60–1920

**Default:** 300

cfgSerialConsoleNoAuth

Enables or disables the CMC serial console login authentication.

**Configuration options:** 0 (enabled), 1 (disabled)

**Default:** 0

### **cfgSerialConsoleCommand**

Specifies a serial command that is executed after a user logs in to the serial console interface.

**Example:** `"connect server-1"`

**Default:** " "

### **cfgSerialConsoleHistorySize**

Specifies the maximum size of the serial history buffer.

**Configuration range:** 0–8192

**Default:** 8192

### **cfgSerialTelnetEnable**

Enables or disables the Telnet console interface on the CMC.

**Configuration options:** 1 (true), 0 (false)

**Default:** 0

### **cfgSerialSshEnable**

Enables or disables the secure shell (SSH) interface on the CMC.

**Configuration options:** 1 (true), 0 (false)

**Default:** 1

## Example

```
racadm getconfig -g cfgSerial

cfgSerialBaudRate=115200
cfgSerialConsoleEnable=1
cfgSerialConsoleQuitKey=^\
cfgSerialConsoleIdleTimeout=1920
cfgSerialConsoleNoAuth=0
cfgSerialConsoleCommand="connect server-1"
cfgSerialHistorySize=1000
cfgSerialTelnetEnable=0
cfgSerialSshEnable=1
```

## cfgNetTuning



**NOTE:** Use this object with the `config` or `getconfig` subcommands.



**NOTE:** To use this object property, you must have **Chassis Configuration Administrator** privilege.

### Description

Displays and configures CMC network tuning parameters.

### cfgNetTuningNicSpeed

Specifies the speed for the CMC NIC. This property is used only if `cfgNetTuningNicAutoNeg` is set to 0 (disabled). **Configuration options:** 10, 100, 1000

**Default:** 1000

### cfgNetTuningNicFullDuplex

Specifies the duplex setting for the CMC NIC. This property is used only if `cfgNetTuningNicAutoNeg` is set to 0 (disabled). **Configuration options:** 0 (half duplex), 1 (full duplex)

**Default:** 1

## cfgNetTuningNicMtu

Specifies the size in bytes of the maximum transmission unit used by the CMC NIC. **Configuration range:** 576–1500

**Default:** 1500

## cfgNetTuningNicAutoneg

Enables auto-negotiation of physical link speed and duplex. When enabled, auto-negotiation takes priority over values set in the `cfgNetTuningNicSpeed` and `cfgNetTuningNicFullDuplex` objects. **Configuration options:** 1 (enabled), 0 (disabled)

**Default:** 1

### Example

```
racadm getconfig -g cfgNetTuning
cfgNetTuningNicSpeed=100
cfgNetTuningNicFullDuplex=1
cfgNetTuningNicMtu=1500
cfgNetTuningNicAutoneg=1
```

## cfgOobSnmp



**NOTE:** Use this object with the `config` or `getconfig` subcommands.



**NOTE:** To use this object property, you must have **Chassis Configuration Administrator** privilege.



**NOTE:** You can configure any setting that is not preceded by the hash sign (#) in the output. To modify a configurable object, use the `-o` option.

### Description

Enables or disables SNMP traps for the CMC.

## cfgOobSnmpAgentEnable

Enables or disables the SNMP agent in the CMC.

**Configuration options:** 1 (true), 0 (false)

**Default:** 0

## cfgOobSnmAgentCommunity

Sets the community string (identical to the community name) used for authentication. The community string acts as a password shared between different hosts over the network. This community string value must match with that of the other hosts for any kind of communication through SNMP.

### Example

```
racadm getconfig -g cfgOobSnm  
cfgOobSnmTrapsEnable=1  
cfgOobSnmAgentCommunity=public
```

## cfgTraps



**NOTE:** Use this object with the **config** or **getconfig** subcommands.



**NOTE:** To use this object property, you must have **Chassis Configuration Administrator** privilege.



**NOTE:** You can configure any setting that is not preceded by the hash sign (#) in the output. To modify a configurable object, use the **-o** option.

### Description

Displays information for and configures delivery of SNMP traps for a specific user.

### # cfgTrapsIndex

**Read only.** Indicates the unique index of an alert instance.

### cfgTrapsEnable

Enables or disables event traps on the CMC.

**Configuration options:** 1 (true), 0 (false)

### cfgTrapsAlertDestIpAddr

Sets the IP address that will receive the alert.

**Configuration options:** A string representing a valid IP address. For example, 192.168.0.20.

## cfgTrapsCommunityName

Sets the community string (identical to the community name) used for authentication. The community string acts as a password shared between different hosts over the network. This community string value must match with that of the other hosts for any kind of communication through SNMP.

### Example

```
racadm getconfig -g cfgTraps -i 2
# cfgTrapsIndex=2
cfgTrapsEnable=1
cfgTrapsAlertDestIpAddr=
cfgTrapsCommunityName=public
```

## cfgAlerting



**NOTE:** Use this object with the **config** or **getconfig** subcommands.



**NOTE:** To use this object property, you must have **Chassis Configuration Administrator** privilege.

### Description

Enables or disables SNMP event trap alerting and sets the event filter.

### cfgAlertingEnable

Enables or disables event traps on the CMC.

**Configuration options:** 1 (true), 0 (false)

### cfgAlertingFilterMask

**Configuration options:** Hex values 0x0–0x003fffff. For information on hex values for events, see Table 11-2.

**Default:** 0x3ff8db

### Examples

- ```
racadm getconfig -g cfgAlerting -o
  cfgAlertingEnable
  0x003fffff
```

- `racadm config -g cfgAlerting -o cfgAlertingEnable 1`

Object value modified successfully.

## cfgRacTuning



**NOTE:** Use this object with the `config` or `getconfig` subcommands.



**NOTE:** To use this object property, you must have **Chassis Configuration Administrator** privilege.



**NOTE:** You can configure any setting that is not preceded by the hash sign (#) in the output. To modify a configurable object, use the `-o` option.

### Description

Configures CMC tuning parameters.

### cfgRacTuneRemoteRacadmEnable

Enables or disables the Remote RACADM interface in the CMC.

Configuration options: 1 (true), 0 (false)

Default: 1

### cfgRacTuneWebserverEnable

Enables and disables the CMC Web server. If this property is set to 0 (FALSE, or disabled), you cannot access the CMC through client Web browsers or remote RACADM. This property has no effect on the Telnet/SSH/serial or local RACADM interfaces.

Configuration options: 1 (true), 0 (false)

Default: 1

### cfgRacTuneHttpPort

Specifies the port number to use for HTTP network communication with the CMC.

Configuration range: 10–65535

Default: 80

### **cfgRacTuneHttpsPort**

Specifies the port number to use for HTTPS network communication with the CMC.

Configuration range: 10–65535

Default: 443

### **cfgRacTuneTelnetPort**

Specifies the port number used for the CMC telnet interface.

Configuration range: 10–65535

Default: 23

### **cfgRacTuneSshPort**

Specifies the port number used for the CMC SSH interface.

Configuration range: 10–65535

Default: 22

### **cfgRacTuneIpRangeEnable**

Enables or disables the IP address Range validation feature of the CMC.

Configuration options: 1 (true), 0 (false)

Default: 0

### **cfgRacTuneIpRangeAddr**

Specifies the acceptable IP address bit pattern in positions determined by the 1's in the range mask property (**cfgRacTuneIpRangeMask**).

Configuration options: IP address-formatted string. For example, 192.168.0.44.

Default: 192.168.1.1

### **cfgRacTunelpRangeMask**

Specifies the IP range mask property.

**Configuration options:** A bitmask value that is applied left-justified bits. For example, 255.255.255.0.

**Default:** 255.255.255.0

### **cfgRacTunelpBlkEnable**

Enables or disables the IP address blocking feature of the CMC.

**Configuration options:** 1 (true), 0 (false)

**Default:** 0

### **cfgRacTunelpBlkFailCount**

Sets the maximum number of login failures to occur in the window before the login attempts from the IP address are rejected.

**Configuration range:** 2–16

**Default:** 5

### **cfgRacTunelpBlkFailWindow**

Defines the time span in seconds within which the failed attempts are counted. When the failure attempts age to this limit, the failures are dropped from the count.

**Configuration range:** 2–65535

**Default:** 60

### **cfgRacTunelpBlkPenaltyTime**

Defines the time span in seconds during which session requests from an IP address with excessive failures are rejected.

**Configuration range:** 2–65535

**Default:** 300



## cfgRacTuneTimezoneOffset

Specifies the number of seconds' difference from Coordinated Universal Time (UTC)/Greenwich Mean Time (GMT). This value is negative if current time zone is west of Greenwich.

## cfgRacTuneDaylightOffset

Specifies the number of seconds of Daylight Savings included in the current time zone. This value is 0 if the time zone is not a Daylight Saving time zone.

### Example

```
racadm getconfig -g cfgRacTuning

cfgRacTuneRemoteRacadmEnable=1
cfgRacTuneWebserverEnable=1
cfgRacTuneHttpPort=80
cfgRacTuneHttpsPort=443
cfgRacTuneTelnetPort=23
cfgRacTuneSshPort=22
cfgRacTuneIpRangeEnable=0
cfgRacTuneIpRangeAddr=192.168.1.1
cfgRacTuneIpRangeMask=255.255.255.0
cfgRacTuneIpBlkEnable=0
cfgRacTuneIpBlkFailCount=5
cfgRacTuneIpBlkFailWindow=60
cfgRacTuneIpBlkPenaltyTime=300
cfgRacTuneTimezoneOffset=0
cfgRacTuneDaylightOffset=0
```

## cfgRacSecurity



**NOTE:** Use this object with the `config` or `getconfig` subcommands.



**NOTE:** To use this object property, you must have **Chassis Configuration Administrator** privilege.

### Description

Configures settings related to the CMC SSL certificate signing request (CSR) feature.



**NOTE:** You must configure the properties in this group before you can generate a CSR from the CMC.

For more information on generating certificate signing requests using RACADM, see "sslcsrgen" on page 344.

### **cfgRacSecCsrKeySize**

Specifies the SSL asymmetric key size for the CSR.

Configuration options: 512, 1024, 2048

Default: 1024

### **cfgRacSecCsrCommonName**

Specifies the CSR Common Name (CN).

Configuration options: String of up to 254 characters.

Default: [null]

### **cfgRacSecCsrOrganizationName**

Specifies the CSR Organization Name (O).

Legal value: String of up to 254 characters.

Default: [null]

### **cfgRacSecCsrOrganizationUnit**

Specifies the CSR Organization Unit (OU).

Legal value: String of up to 254 characters.

Default: [null]

### **cfgRacSecCsrLocalityName**

Specifies the CSR Locality (L).

Legal value: String of up to 254 characters.

Default: [null]

### **cfgRacSecCsrStateName**

Specifies the CSR State Name (S).

**Legal value:** String of up to 254 characters.

**Default:** [null]

### **cfgRacSecCsrCountryCode**

Specifies the CSR Country Code (CC).

**Legal value:** String of up to 254 characters.

**Default:** [null]

### **cfgRacSecCsrEmailAddr**

Specifies the CSR e-mail address.

**Legal value:** String of up to 254 characters.

**Default:** [null]

### **Example**

```
racadm config -g cfgRacSecurity
cfgRacSecCsrKeySize=1024
cfgRacSecCommonName=
cfgRacSecOrganizationName=
cfgRacSecOrganizationUnit=
cfgRacSecLocalityName=
cfgRacSecStateName=
cfgRacSecCountryCode=
cfgRacSecEmailAddr=
```

## **cfgActiveDirectory**



**NOTE:** Use this object with the **config** or **getconfig** subcommands.



**NOTE:** To use this object property, you must have **Chassis Configuration Administrator** privilege.



**NOTE:** You can configure any setting that is not preceded by the hash sign (#) in the output. To modify a configurable object, use the **-o** option.

### **Description**

Configures Microsoft® Active Directory® properties.

### **cfgADEnable**

Enables or disables Active Directory user authentication on the CMC. If this property is disabled, local CMC authentication is used for user logins instead.  
**Configuration options:** 1 (true), 0 (false)

**Default:** 0

### **cfgAD RacDomain**

Specifies the Active Directory domain on which the CMC resides.  
**Configuration options:** String of up to 254 characters with no spaces.

**Default:** [null]

### **cfgADRootDomain**

Specifies the root domain of the domain forest. **Configuration options:** String of up to 254 characters with no spaces.

**Default:** [null]

### **cfgAD RacName**

Specifies the name of CMC as recorded in the Active Directory forest. **Configuration options:** String of up to 254 characters with no spaces.

**Default:** [null]

### **cfgADAuthTimeout**

Specifies the number of seconds to wait for Active Directory authentication requests to complete before timing out. **Configuration range:** 15–300

**Default:** 120

### **cfgADType**

Indicates the schema type (extended or standard) to use with Active Directory.

**Configuration options:** 1 (extended), 2 (standard)

**Default:** 1 (extended)

## cfgADSpecifyServerEnable

Allows you to enable/disable and specify an LDAP server or a global catalog server. Use `cfgADDomainController` or `cfgADGlobalCatalog` to specify the IP address.

**Configuration options:** 1 (enabled), 0 (disabled)

**Default:** 0 (disabled)

## cfgADDomainController

Specifies the LDAP server from which you want the CMC to obtain user names. **Must be used with `cfgADSpecifyServerEnable`.**

**Legal value:** Valid IP address or fully qualified domain name (FQDN).

## cfgADGlobalCatalog

Specifies the global catalog server from which you want the CMC to obtain user names. **Must be used with `cfgADSpecifyServerEnable`.**

**Legal value:** Valid IP address or FQDN.

## Example

```
racadm getconfig -g cfgActiveDirectory
cfgADEnable=1
cfgADRacDomain=
cfgADRootDomain=help
cfgADRacName=
cfgADRacAuthTimeout=300
cfgADRacType=0x4
cfgADRacSpecifyServerEnable=1
cfgRacADDomainController=192.168.1.1
cfgRacADGlobalCatalog=127.0.0.1
```

## cfgStandardSchema



**NOTE:** Use this object with the `config` or `getconfig` subcommands.



**NOTE:** To use this object property, you must have **Chassis Configuration Administrator** privilege.



**NOTE:** You can configure any setting that is not preceded by the hash sign (#) in the output. To modify a configurable object, use the **-o** option.

## Description

Configures the Standard Schema settings for Active Directory.

### # **cfgSSADRoleGroupIndex**

**Read only.** Displays the index of the Role Group as recorded in the Active Directory.

**Configuration range:** 1–5

### **cfgSSADRoleGroupName**

Specifies the name of the Role Group as recorded in the Active Directory forest.

**Configuration options:** String of up to 254 characters with no spaces.

**Default:** [null]

### **cfgSSADRoleGroupDomain**

Specifies the Active Directory Domain in which the Role Group resides.

**Configuration options:** String of up to 254 characters with no spaces.

### **cfgSSADRoleGroupPrivilege**

Specifies the bit mask numbers (see Table B-1) to set role-based authority privilege for a Role Group.

**Configuration range:** 0x00000000–0x000001ff

**Default:** [null]

## Example

```
racadm getconfig -g cfgStandardSchema

# cfgSSADRoleGroupIndex=1
cfgSSADRoleGroupName=blsys-1
cfgSSADRoleGroupDomain=
cfgSSADRoleGroupPrivilege=3081
```

# cfgChassisPower



**NOTE:** Use this object with the **config** or **getconfig** subcommands.



**NOTE:** To use this object property, you must have **Chassis Configuration Administrator** privilege.



**NOTE:** You can configure any setting that is not preceded by the hash sign (#) in the output. To modify a configurable object, use the **-o** option.

## Description

Displays information for and configures power for the chassis.

### # cfgChassisActualACPowerConsumption

**Read only.** Indicates the cumulative AC input power consumption data (in watts) captured from all healthy and functional PSUs in the chassis.

### # cfgChassisPeakPowerConsumption

**Read only.** The maximum system level AC power consumption (in watts) since the value was last cleared by a user.

### # cfgChassisPeakPowerConsumptionTimestamp

**Read only.** The timestamp recorded when the peak system power consumption value occurred.

### # cfgChassisMinPowerConsumption

**Read only.** The minimum system level AC power consumption value (in watts) over the time since the value was last cleared.

### # cfgChassisMinPowerConsumptionTimestamp

**Read only.** The timestamp recorded when the minimum system power consumption occurred.

### # cfgChassisPowerStatus

**Read only.** Indicates the power status of the chassis.

**Configuration options:** 1 (other), 2 (unknown), 3 (OK), 4 (non-critical), 5 (critical), 6 (non-recoverable)

### # **cfgChassisRedundantState**

Read only. Enables or disables power redundancy for the chassis.

Values: 0 (none), 1 (full)

### **cfgChassisMaxACPowerLimit**

Indicates the maximum power consumption limit (in watts) for the entire chassis.

Configuration range: 2768–7928 watts

Default: 7928 watts

### **cfgChassisACPowerWarningThreshold**

Indicates the maximum amount of power (in watts) beyond which the CMC takes action to reduce power consumption.

### **cfgChassisServerPowerThrottling**

Enables or disables the CMC to siphon power from lower priority servers when power is needed for the entire chassis. In this case, the servers are allowed to continue operating at a degraded performance level rather than shut down. Configuration options: 0 (disabled), 1 (enabled). Default: 1

### **cfgChassisRedundancyPolicy**

Sets the redundancy policy of the chassis.

Configuration options: 0 (no redundancy), 1 (AC redundancy), 2 (power supply redundancy).

Default: 0 (no redundancy)

### **cfgChassisDynamicPSUEngagementEnable**

Enables or disables dynamic engagement.

Configuration options: 0 (disabled), 1 (enabled)

Default: 0 (disabled)



### **# cfgChassisDCMaxPowerCapacity**

**Read only.** Indicates the total chassis power budget (in watts) available for chassis operation.

### **# cfgChassisDCRedundancyReserve**

**Read only.** Indicates the amount of redundant power (in watts) in reserve that can be utilized in the event of an AC grid or PSU failure. This value is 0 if the Redundancy Policy is set to 0 (no redundancy).

### **# cfgChassisDCPowerServerAllocation**

**Read only.** Indicates (in watts) the cumulative power allocated to servers.

**Default:** 7928

If `cfgChassisDynamicPSUEngagementEnable` is set to 1 (enabled) and the chassis power consumption exceeds the power warning threshold, then the performance of lower priority servers is reduced until total power consumption falls below the threshold.

If `cfgChassisDynamicPSUEngagementSet` is set to 0 (disabled), servers with lower priority may be powered off until total power consumption falls below the threshold.

### **# cfgChassisInfrastructureDCPowerAllocation**

**Read only.** Indicates the estimated cumulative DC output power consumption (in watts), determined from a field replaceable unit (FRU) on the hardware modules in the chassis.

### **# cfgChassisTotalDCPowerAvailable**

**Read only.** Indicates the amount of power (in watts) available for use by the chassis.

### **# cfgChassisStandbyPowerCapacity**

**Read only.** Indicates the amount of power (in watts) available for powering up any hardware modules that are either added to the chassis or powered up (if they are already present in the chassis).

## # cfgChassisPowerConsumptionClear

Write only. To reset `cfgChassisMinPowerConsumption` and `cfgChassisMAXPowerConsumption`, set this object to 1.

## # cfgChassisPowerConsumptionClearTimestamp

Read only.

## cfgChassisPowerButtonEnable

Indicates if the chassis power button is enabled or disabled.

Values: 0 (disabled), 1 (enabled)

## Examples

- ```
racadm getconfig -g cfgChassisPower
# cfgChassisActualACPowerConsumption=0 watts
# cfgChassisPeakPowerConsumption=0 watts
# cfgChassisPeakPowerConsumptionTimestamp=
16:55:48 12/10/2007
# cfgChassisMinPowerConsumption=0 watts
# cfgChassisMinPowerConsumptionTimestamp=16:55:48
12/10/2007
# cfgChassisPowerStatus=5
# cfgChassisRedundantState=0
cfgChassisMaxACPowerLimit=7928 watts
cfgChassisACPowerWarningThreshold=7130 watts
cfgChassisServerPowerThrottling=1
cfgChassisRedundancyPolicy=0
cfgChassisDynamicPSUEngagementEnable=0
# cfgChassisDCMaxPowerCapacity=0 watts
# cfgChassisDCRedundancyReserve=0 watts
# cfgChassisDCPowerServerAllocation=0 watts
# cfgChassisInfrastructureDCPowerAllocation=51
watts
# cfgChassisTotalDCPowerAvailable=0 watts
# cfgChassisStandbyPowerCapacity=0 watts
# cfgChassisPowerConsumptionClear=***** (Write-
Only)
```

- ```
# cfgChassisPowerConsumptionClearTimestamp=
18:00:00 12/31/1969
cfgChassisPowerButtonEnable=1
```
- `racadm config -g cfgChassisPower -o cfgChassisPowerConsumptionClear 1`  
Clears `cfgChassisMinPowerConsumption` and `cfgChassisPeakPowerConsumption`.

## cfgServerInfo



**NOTE:** Use this object with the `config` or `getconfig` subcommands.



**NOTE:** To use this object property, you must have **Chassis Configuration Administrator** privilege.



**NOTE:** You can configure any setting that is not preceded by the hash sign (#) in the output. To modify a configurable object, use the `-o` option.

### Description

Displays information for and configures a server in the chassis.

### # cfgServerInfoIndex

Read only. Displays the index name of the server.

### # cfgServerSlotNumber

Read only. Specifies the location of the specified server (1–16) in the chassis.

### # cfgServerServiceTag

Read only. Displays the service tag of the specified server.

### cfgServerName

Specifies the name of the specified server.

**Configuration options:** String of up to 15 alphanumeric characters, periods, and dashes.

Default: `SLOT-<slot number>`

`# cfgServerBmcMacAddress`

Read only. Displays the BMC MAC address of the specified server.

### **# cfgServerNic1MacAddress**

Read only. Displays the MAC address of the server NIC.

### **# cfgServerNic2MacAddress**

Read only. Displays the MAC address of the server NIC.

### **cfgServerPriority**

Sets the priority level allotted to the server in the chassis for power budgeting purposes.

**Configuration range:** 1–9 in descending priority, where 1 holds the highest priority

**Default:** 1

### **cfgServerNicEnable**

Enables or disables LAN channel.

**Configuration options:** 0 (disable), 1 (enable)

### **cfgServerIPMIOverLanEnable**

Enables or disables IPMI LAN channel.

**Configuration options:** 0 (disable), 1 (enable)

### **Example**

```
racadm getconfig -g cfgServerInfo -i 1
# cfgServerInfoIndex=1
cfgServerSlotNumber=1
# cfgServerServiceTag=JGPRQ61
cfgServerName=Server-1
# cfgServerBmcMacAddress=00:11:43:FD:B7:2A
# cfgServerNic1MacAddress=00:11:43:FD:B7:2A
# cfgServerNic2MacAddress=N/A
```

```
cfgServerPriority=9
cfgServerNicEnable=1
cfgServerIPMIOverLanEnable=1
```

## cfgKVMInfo



**NOTE:** Use this object with the **config** or **getconfig** subcommands.



**NOTE:** To use this object property, you must have **Chassis Configuration Administrator** privilege.



**NOTE:** You can configure any setting that is not preceded by the hash sign (#) in the output. To modify a configurable object, use the **-o** option.

### Description

Displays information for and configures the iKVM.

### cfgKVMAccessToCMCEnable

Enables or disables the Dell CMC Console access on the iKVM.

**Configuration options:** 1 (enable), 0 (disable)

### cfgKVMFrontPanelEnable

Enables or disables front panel access on the iKVM.

**Configuration options:** 1 (enable), 0 (disable)

### Example

```
racadm getconfig -g cfgKVMInfo
cfgKVMAccessToCMCEnable=1
cfgKVMFrontPanelEnable=1
```



# Using the LCD Panel Interface

You can use the LCD panel to perform configuration and diagnostics, and to obtain status information about the chassis and its contents.

## LCD Navigation





Use the buttons to the right of the LCD screen to operate the LCD panel. The up, down, left, and right arrow buttons change the selected menu items or icons on the screen. The selected item is shown with a light blue background or border.

The center button activates the selected item.

When messages displayed on the LCD screen are longer than will fit on the screen, use the left and right arrow buttons to scroll the text left and right.

The icons described in Table C-1 are used in navigating between LCD screens:

**Table C-1. LCD Panel Navigational Icons**

| Icon                                                                                | Description                                                                                                               |
|-------------------------------------------------------------------------------------|---------------------------------------------------------------------------------------------------------------------------|
|    | <b>Back.</b> Highlight and press the center button to return to the previous screen.                                      |
|  | <b>Accept/Yes.</b> Highlight and press the center button to accept a change and return to the previous screen.            |
|  | <b>Skip/Next.</b> Highlight and press the center button to skip any changes and go to the next screen.                    |
|  | <b>Rotate.</b> Highlight and press the center button to switch between the front and rear graphical views of the chassis. |

## Main Menu

From the **Main** menu you can navigate to one of the following screens:

- **LCD Setup Menu** — select the language to use and the LCD screen that displays when no one is using the LCD.

- **Server** — displays status information for servers.
  - **Enclosure** — displays status information for the chassis.
- 1 Use the up and down arrow buttons to highlight an item.
  - 2 Press the center button to activate your selection.

## LCD Setup Menu

The **LCD Setup** menu displays a menu of items that can be configured:

- **Language Setup** — choose the language you want to use for LCD screen text and messages.
  - **Default Screen** — choose the screen that displays when there is no activity on the LCD panel.
- 1 Use the up and down arrow buttons to highlight an item in the menu or highlight the **Back** icon if you want to return to the **Main** menu.
  - 2 Press the center button to activate your selection.

## Language Setup Screen

The **Language Setup** screen allows you to select the language used for LCD panel messages. The currently active language is highlighted with a light blue background.

- 1 Use the up, down, left, and right arrow buttons to highlight the desired language.
- 2 Press the center button. The **Accept** icon appears and is highlighted.
- 3 Press the center button to confirm the change. The **LCD Setup** menu is displayed.

## Default Screen

The **Default Screen** allows you to change the screen that the LCD panel displays when there is no activity at the panel. The factory default screen is the **Main Menu**. You can choose from the following screens to display:

- **Main Menu**
- **Server Status** (front graphical view of the chassis)
- **Module Status** (rear graphical view of the chassis)
- **Custom** (Dell logo with chassis name)



The currently active default screen is highlighted in light blue.

- 1 Use the up and down arrow buttons to highlight the screen you want to set to the default.
- 2 Press the center button. The **Accept** icon is highlighted.
- 3 Press the center button again to confirm the change. The **LCD Setup** menu is displayed.

## Graphical Server Status Screen

The **Graphical Server Status** screen displays icons for each server installed in the chassis and indicates the general health status for each server. The server health is indicated by the color of the server icon:

- Gray — server is off with no errors
- Green — server is on with no errors
- Amber — server has one or more errors
- Black — server is not present

A blinking light blue rectangle around a server icon indicates that the server is highlighted.

To view the **Graphical Module Status** screen:

- 1 Highlight the rotate icon.
- 2 Press the center button.

To view the status screen for a server:

- 1 Use the arrow buttons to highlight the desired server.
- 2 Press the center button. The **Server Status** screen displays.

To return to the Main Menu:

- 1 Use the arrow buttons to highlight the **Back** icon.
- 2 Press the center button.

## Graphical Module Status Screen

The **Graphical Module Status** screen displays all modules installed in the rear of the chassis and provides summary health information for each module. Module health is indicated by the color of each module icon as follows:

- Gray — module is off or on standby with no errors
- Green — module is on with no errors
- Amber — module has one or more errors
- Black — module is not present

A blinking light blue rectangle around a module icon indicates that the module is highlighted.

To view the **Graphical Server Status** screen:

- 1 Highlight the rotate icon.
- 2 Press the center button.

To view the status screen for a module:

- 1 Use the up, down, left, and right arrow buttons to highlight the desired module.
- 2 Press the center button. The **Module Status** screen displays.

To return to the **Main Menu**:

- 1 Use the arrow buttons to highlight the **Back** icon.
- 2 Press the center button. The **Main Menu** displays.

## Enclosure Menu Screen

From this screen you can navigate to the following screens:

- **Module Status** screen
  - **Enclosure Status** screen
  - **IP Summary** screen
  - **Main Menu**
- 1 Use the navigation buttons to highlight the desired item. (Highlight the **Back** icon to return to the **Main Menu**.)
  - 2 Press the center button. The selected screen displays.

## Module Status Screen

The **Module Status** screen displays information and error messages about a module. See "LCD Module and Server Status Information" on page 402 and "LCD Error Messages" on page 392 for messages that can appear on this screen.

Use the up and down arrow keys to move through messages. Use the left and right arrow keys to scroll messages that do not fit on the screen.

Highlight the **Back** icon and press the center button to return to the **Graphical Module Status** screen.

## Server Status Screen

The **Server Status** screen displays information and error messages about a server. See "LCD Module and Server Status Information" on page 402 and "LCD Error Messages" on page 392 for messages that can appear on this screen.

Use the up and down arrow keys to move through messages. Use the left and right arrow keys to scroll messages that do not fit on the screen.

Highlight the **Back** icon and press the center button to return to the **Graphical Server Status** screen.

## IP Summary Screen

The **IP Summary** screen shows IP information for the CMC and the iDRAC of each installed server.

Use the up and down arrow buttons to scroll through the list. Use the left and right arrow buttons to scroll selected messages that are longer than the screen.

Use the up and down arrow buttons to select the **Back** icon and press the center button to return to the **Enclosure** menu.

## Diagnostics

The LCD panel helps you to diagnose problems with any server or module in the chassis. If there is a problem or fault with the chassis or any server or other module in the chassis, the LCD panel status indicator blinks amber. On the **Main Menu** a blinking icon with an amber background displays next to the menu item—Server or Enclosure—that leads to the faulty server or module.

By following the blinking amber icons down through the LCD menu system, you can display the status screen and error messages for the item that has the problem.

Error messages on the LCD panel can be removed by removing the module or server that is the cause of the problem or by clearing the hardware log for the module or server. For server errors, use the iDRAC Web interface or command line interface to clear the server's System Event Log (SEL). For chassis errors, use the CMC Web interface or command line interface to clear the hardware log.

## **LCD Hardware Troubleshooting**

If you are experiencing issues with the LCD in relation to your use of the CMC, use the following hardware troubleshooting items to determine if there is an LCD hardware or connection issue.

**Figure C-1. Removing and Installing the LCD Module**

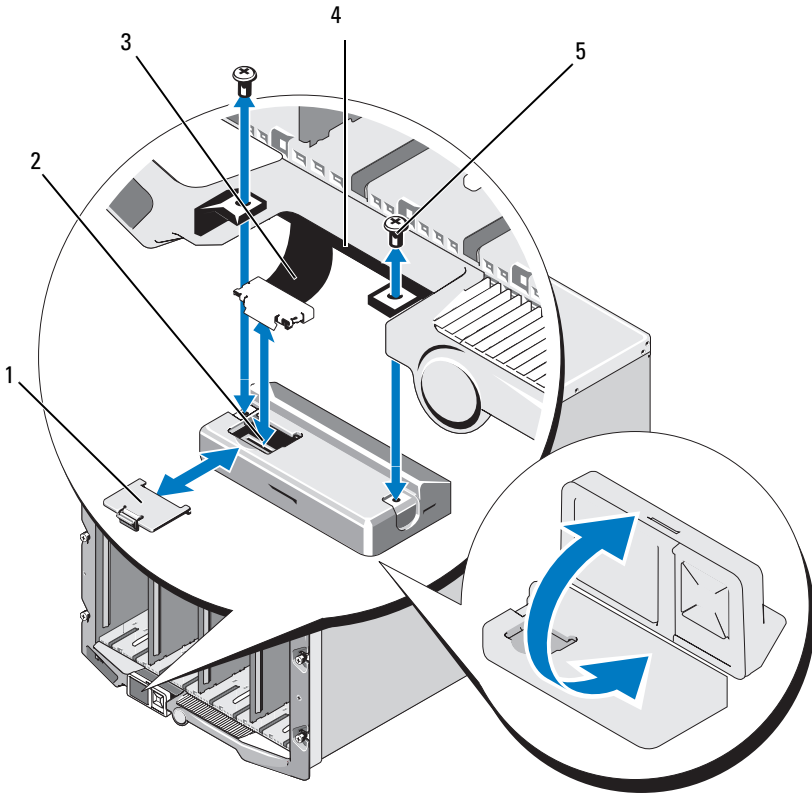

- 1 cable cover
- 3 ribbon cable
- 5 screws (2)

- 2 LCD module
- 4 hinges (2)

| <b>Symptom</b>                                                             | <b>Issue</b>                                                                                                    | <b>Recovery Action</b>                                                                                                                                                                                                    |
|----------------------------------------------------------------------------|-----------------------------------------------------------------------------------------------------------------|---------------------------------------------------------------------------------------------------------------------------------------------------------------------------------------------------------------------------|
| Alert screen message "CMC Not Responding" and LED is blinking amber        | Loss of communication from CMC to the LCD front panel                                                           | Check that the CMC is booting; then, reset the CMC using GUI or RACADM commands                                                                                                                                           |
| Alert screen message "CMC Not Responding" and LED is solid amber or is off | LCD front panel stuck in boot block during a CMC failover                                                       | Disconnect and reconnect the front panel circuit board to the I/O panel cable from front panel. Reset the CMC using GUI or RACADM commands                                                                                |
| LED blinks amber or is blank                                               | The LCD to front panel circuit board cable is not connected properly or is faulty, or the front panel is faulty | Review the hardware log using the GUI or RACADM commands. Look for a message that states:<br><br>Control Panel TFT Cable: Cable sensor for Control Panel, configuration error was asserted<br><br>Replace the front panel |
| Screen text is scrambled                                                   | Defective LCD screen                                                                                            | Replace the front panel                                                                                                                                                                                                   |
| LCD screen message "No CMC Found"                                          | No CMC is present in the chassis                                                                                | Insert a CMC into the chassis or replace existing CMC if present and nonfunctional                                                                                                                                        |

| Symptom               | Issue                                                                                                             | Recovery Action                                                                                                                                                                                                                                                                                                                                              |
|-----------------------|-------------------------------------------------------------------------------------------------------------------|--------------------------------------------------------------------------------------------------------------------------------------------------------------------------------------------------------------------------------------------------------------------------------------------------------------------------------------------------------------|
| Blank LCD and LED off | The front panel circuit board cable or the I/O panel cable are not connected properly, or one or both are faulty. | <p>Review the hardware log using the GUI or RACADM commands. Look for messages that state:</p> <pre>Control Panel FPC Cable: Cable sensor for Control Panel, configuration error was asserted</pre> <pre>Control Panel I/O Cable: Cable sensor for Control Panel, configuration error was asserted</pre> <p>Check that the cables are connected properly</p> |

## Front Panel LCD Messages

This section contains two subsections that list error and status information that is displayed on the front panel LCD.

*Error messages* on the LCD have a format that is similar to the System Event Log (SEL) viewed from the CLI or Web interface. The format is as follows:

```
<Severity> <Sensor Name>: <Sensor Type> sensor for
<Entity>, <Description of event>
```

The tables in the error section list the error and warning messages that are displayed on the various LCD screens and the possible cause of the message. Text enclosed in angled brackets (< >) indicates that the text may vary.

*Status information* on the LCD includes descriptive information about the modules in the chassis. The tables in this section describe the information that is displayed for each component.

# LCD Error Messages

**Table C-2. CMC Status Screens**

| <b>Severity</b> | <b>Message</b>                                                       | <b>Cause</b>                                             |
|-----------------|----------------------------------------------------------------------|----------------------------------------------------------|
| Critical        | CMC <number> Battery: Battery sensor for CMC, failed was asserted    | CMC CMOS battery is missing or no voltage.               |
| Critical        | CMC <number> CPU Temp: Temperature sensor for CMC, failure event     | CMC CPU temperature exceeded the critical threshold.     |
| Critical        | CMC <number> Ambient Temp: Temperature sensor for CMC, failure event | CMC Ambient temperature exceeded the critical threshold. |

**Table C-3. Enclosure/Chassis Status Screen**

| <b>Severity</b> | <b>Message</b>                                                                                        | <b>Cause</b>                                                                                                                                        |
|-----------------|-------------------------------------------------------------------------------------------------------|-----------------------------------------------------------------------------------------------------------------------------------------------------|
| Critical        | Chassis Fan <number> Presence: Fan sensor for Chassis Fan, device removed was asserted                | This fan is required for proper cooling of the enclosure/chassis.                                                                                   |
| Warning         | Power Supply Redundancy: PS Redundancy sensor for Power Supply, redundancy degraded was asserted      | One or more PSU have failed or removed and the system can no longer support full PSU redundancy.                                                    |
| Critical        | Power Supply Redundancy: PS Redundancy sensor for Power Supply, redundancy lost was asserted          | One or more PSU have failed or removed and the system is no longer redundant.                                                                       |
| Critical        | Power Supply Redundancy: PS Redundancy sensor for Power Supply, non-redundant: insufficient resources | One or more PSU have failed or removed and the system lacks sufficient power to maintain normal operations. This could cause servers to power down. |
| Critical        | Control Panel Temp: Temperature sensor for Control Panel, failure event                               | Chassis/Enclosure temperature exceeded the critical threshold.                                                                                      |



**Table C-3. Enclosure/Chassis Status Screen (continued)**

| <b>Severity</b> | <b>Message</b>                                                                                       | <b>Cause</b>                                                                                               |
|-----------------|------------------------------------------------------------------------------------------------------|------------------------------------------------------------------------------------------------------------|
| Critical        | CMC <number> Standalone: Micro Controller sensor for CMC, non-redundant was asserted                 | CMC no longer redundant.<br><b>NOTE:</b> This will only show if the standby CMC was removed or has failed. |
| Critical        | Chassis Eventlog CEL: Event Log sensor for Chassis Eventlog, all event logging disabled was asserted | The CMC cannot log events.                                                                                 |
| Critical        | Chassis Eventlog CEL: Event Log sensor for Chassis Eventlog, log full was asserted                   | Chassis device detects that only one entry can be added to the CEL before it is full.                      |
| Warning         | Chassis Eventlog CEL: Event Log sensor for Chassis Eventlog, log almost full was asserted            | Chassis event log is 75% full.                                                                             |

**Table C-4. Fan Status Screens**

| <b>Severity</b> | <b>Message</b>                                                         | <b>Cause</b>                                                                              |
|-----------------|------------------------------------------------------------------------|-------------------------------------------------------------------------------------------|
| Critical        | Chassis Fan <number> Status: Fan sensor for Chassis Fan, failure event | The speed of the specified fan is not sufficient to provide enough cooling to the system. |

**Table C-5. IOM Status Screens**

| <b>Severity</b> | <b>Message</b>                                                                                                 | <b>Cause</b>                                                                                     |
|-----------------|----------------------------------------------------------------------------------------------------------------|--------------------------------------------------------------------------------------------------|
| Warning         | I/O Module <number> Status: Module sensor for I/O Module, transition to non-critical from OK was asserted      | The IO module was good, but now having fabric mismatch or link tuning mismatch.                  |
| Critical        | I/O Module <number> Status: Module sensor for I/O Module, transition to critical from less severe was asserted | The I/O module has a fault. The same error can also happen if the I/O module is thermal-tripped. |

**Table C-6. iKVM Status Screen**

| <b>Severity</b> | <b>Message</b>                                                                                      | <b>Cause</b>                                   |
|-----------------|-----------------------------------------------------------------------------------------------------|------------------------------------------------|
| Warning         | Local KVM Health: Module sensor for Local KVM, transition to non-critical from OK was asserted      | Minor failure, such as corrupted firmware.     |
| Critical        | Local KVM Health: Module sensor for Local KVM, transition to critical from less severe was asserted | USB host enumeration failure or OSCAR failure. |
| Non-Recoverable | Local KVM Health: Module sensor for Local KVM, transition to non-recoverable was asserted           | Serial RIP failure or USB host chip failure.   |

**Table C-7. PSU Status Screens**

| <b>Severity</b> | <b>Message</b>                                                                           | <b>Cause</b>                           |
|-----------------|------------------------------------------------------------------------------------------|----------------------------------------|
| Critical        | Power Supply PSU <number>: Power Supply sensor for Power Supply, failure was asserted    | The PSU has failed.                    |
| Critical        | Power Supply PSU <number>: Power Supply sensor for Power Supply, input lost was asserted | Loss of AC power or AC cord unplugged. |

**Table C-8. Server Status Screen**

| <b>Severity</b> | <b>Message</b>                                                                  | <b>Cause</b>                                            |
|-----------------|---------------------------------------------------------------------------------|---------------------------------------------------------|
| Warning         | System Board Ambient Temp: Temperature sensor for System Board, warning event   | Server Ambient temperature crossed a warning threshold. |
| Critical        | System Board Ambient Temp: Temperature sensor for System Board, failure event   | Server Ambient temperature crossed a failing threshold. |
| Critical        | System Board CMOS Battery: Battery sensor for System Board, failed was asserted | CMOS battery is not present or has no voltage.          |

**Table C-8. Server Status Screen (continued)**

| <b>Severity</b> | <b>Message</b>                                                                                   | <b>Cause</b>                                   |
|-----------------|--------------------------------------------------------------------------------------------------|------------------------------------------------|
| Warning         | System Board System Level: Current sensor for System Board, warning event                        | Current crossed a warning threshold.           |
| Critical        | System Board System Level: Current sensor for System Board, failure event                        | Current crossed a failing threshold.           |
| Critical        | CPU <number> <voltage sensor name>: Voltage sensor for CPU <number>, state asserted was asserted | Voltage out of range.                          |
| Critical        | System Board <voltage sensor name>: Voltage sensor for System Board, state asserted was asserted | Voltage out of range.                          |
| Critical        | CPU <number> <voltage sensor name>: Voltage sensor for CPU <number>, state asserted was asserted | Voltage out of range.                          |
| Critical        | CPU<number> Status: Processor sensor for CPU<number>, IERR was asserted                          | CPU failure.                                   |
| Critical        | CPU<number> Status: Processor sensor for CPU<number>, thermal tripped was asserted               | CPU overheated.                                |
| Critical        | CPU<number> Status: Processor sensor for CPU<number>, configuration error was asserted           | Incorrect processor type or in wrong location. |
| Critical        | CPU<number> Status: Processor sensor for CPU<number>, presence was de-asserted                   | Required CPU is missing or not present.        |
| Critical        | System Board Video Riser: Module sensor for System Board, device removed was asserted            | Required module was removed.                   |

**Table C-8. Server Status Screen (continued)**

| <b>Severity</b> | <b>Message</b>                                                                                       | <b>Cause</b>                                                                                                                                             |
|-----------------|------------------------------------------------------------------------------------------------------|----------------------------------------------------------------------------------------------------------------------------------------------------------|
| Critical        | Mezz B <slot number> Status: Add-in Card sensor for Mezz B <slot number>, install error was asserted | Incorrect Mezzanine card installed for I/O fabric.                                                                                                       |
| Critical        | Mezz C <slot number> Status: Add-in Card sensor for Mezz C <slot number>, install error was asserted | Incorrect Mezzanine card installed for I/O fabric.                                                                                                       |
| Critical        | Backplane Drive <number>: Drive Slot sensor for Backplane, drive removed                             | Storage Drive was removed.                                                                                                                               |
| Critical        | Backplane Drive <number>: Drive Slot sensor for Backplane, drive fault was asserted                  | Storage Drive failed.                                                                                                                                    |
| Critical        | System Board PFault Fail Safe: Voltage sensor for System Board, state asserted was asserted          | This event is generated when the system board voltages are not at normal levels.                                                                         |
| Critical        | System Board OS Watchdog: Watchdog sensor for System Board, timer expired was asserted               | The iDRAC watchdog timer expires and no action is set.                                                                                                   |
| Critical        | System Board OS Watchdog: Watchdog sensor for System Board, reboot was asserted                      | The iDRAC watchdog detected that the system has crashed (timer expired because no response was received from Host) and the action is set to reboot.      |
| Critical        | System Board OS Watchdog: Watchdog sensor for System Board, power off was asserted                   | The iDRAC watchdog detected that the system has crashed (timer expired because no response was received from Host) and the action is set to power off.   |
| Critical        | System Board OS Watchdog: Watchdog sensor for System Board, power cycle was asserted                 | The iDRAC watchdog detected that the system has crashed (timer expired because no response was received from Host) and the action is set to power cycle. |

**Table C-8. Server Status Screen (continued)**

| <b>Severity</b> | <b>Message</b>                                                                                | <b>Cause</b>                                                                          |
|-----------------|-----------------------------------------------------------------------------------------------|---------------------------------------------------------------------------------------|
| Critical        | System Board SEL: Event Log sensor for System Board, log full was asserted                    | The SEL device detects that only one entry can be added to the SEL before it is full. |
| Warning         | ECC Corr Err: Memory sensor, correctable ECC (<DIMM Location>) was asserted                   | Correctable ECC errors reach a critical rate.                                         |
| Critical        | ECC Uncorr Err: Memory sensor, uncorrectable ECC (<DIMM Location>) was asserted               | An uncorrectable ECC error was detected.                                              |
| Critical        | I/O Channel Chk: Critical Event sensor, I/O channel check NMI was asserted                    | A critical interrupt is generated in the I/O Channel.                                 |
| Critical        | PCI Parity Err: Critical Event sensor, PCI PERR was asserted                                  | Parity error was detected on the PCI bus.                                             |
| Critical        | PCI System Err: Critical Event sensor, PCI SERR (<Slot number or PCI Device ID>) was asserted | PCI error detected by device.                                                         |
| Critical        | SBE Log Disabled: Event Log sensor, correctable memory error logging disabled was asserted    | Single bit error logging is disable when too many SBE get logged.                     |
| Critical        | Logging Disabled: Event Log sensor, all event logging disabled was asserted                   | All error logging is disabled.                                                        |
| Non-Recoverable | CPU Protocol Err: Processor sensor, transition to non-recoverable was asserted                | The processor protocol entered a non-recoverable state.                               |
| Non-Recoverable | CPU Bus PERR: Processor sensor, transition to non-recoverable was asserted                    | The processor bus PERR entered a non-recoverable state.                               |
| Non-Recoverable | CPU Init Err: Processor sensor, transition to non-recoverable was asserted                    | The processor initialization entered a non-recoverable state.                         |

**Table C-8. Server Status Screen (continued)**

| <b>Severity</b> | <b>Message</b>                                                                                    | <b>Cause</b>                                                 |
|-----------------|---------------------------------------------------------------------------------------------------|--------------------------------------------------------------|
| Non-Recoverable | CPU Machine Chk: Processor sensor, transition to non-recoverable was asserted                     | The processor machine check entered a non-recoverable state. |
| Critical        | Memory Spared: Memory sensor, redundancy lost (<DIMM Location>) was asserted                      | Memory spare is no longer redundant.                         |
| Critical        | Memory Mirrored: Memory sensor, redundancy lost (<DIMM Location>) was asserted                    | Mirrored Memory is no longer redundant.                      |
| Critical        | Memory RAID: Memory sensor, redundancy lost (<DIMM Location>) was asserted                        | RAID Memory is no longer redundant.                          |
| Warning         | Memory Added: Memory sensor, presence (<DIMM Location>) was deasserted                            | Added memory module was removed.                             |
| Warning         | Memory Removed: Memory sensor presence (<DIMM Location>) was deasserted                           | Memory module was removed.                                   |
| Critical        | Memory Cfg Err: Memory sensor, configuration error (<DIMM Location>) was asserted                 | Memory configuration is incorrect for the system.            |
| Warning         | Mem Redun Gain: Memory sensor, redundancy degraded (<DIMM Location>) was asserted                 | Memory redundancy is down graded but not lost.               |
| Critical        | PCIE Fatal Err: Critical Event sensor, bus fatal error was asserted                               | Fatal error is detected on the PCIE bus.                     |
| Critical        | Chipset Err: Critical Event sensor, PCI PERR was asserted                                         | Chip error is detected.                                      |
| Warning         | Mem ECC Warning: Memory sensor, transition to non-critical from OK (<DIMM Location>) was asserted | Correctable ECC errors have increased from a normal rate.    |

**Table C-8. Server Status Screen (continued)**

| <b>Severity</b> | <b>Message</b>                                                                                                    | <b>Cause</b>                                                          |
|-----------------|-------------------------------------------------------------------------------------------------------------------|-----------------------------------------------------------------------|
| Critical        | Mem ECC Warning: Memory sensor, transition to critical from less severe (<DIMM Location>) was asserted            | Correctable ECC errors have reached a rate.                           |
| Critical        | System Board POST Err: POST sensor for System Board, POST fatal error <additional error information> was asserted | See Hardware Service Manual for BIOS POST addition error information. |
| Critical        | POST Err: POST sensor, No memory installed                                                                        | No memory detected on board                                           |
| Critical        | POST Err: POST sensor, Memory configuration error                                                                 | Memory detected but is not configurable                               |
| Critical        | POST Err: POST sensor, Unusable memory error                                                                      | Memory configured but not usable                                      |
| Critical        | POST Err: POST sensor, Shadow BIOS failed                                                                         | System BIOS shadow failure                                            |
| Critical        | POST Err: POST sensor, CMOS failed                                                                                | CMOS failure                                                          |
| Critical        | POST Err: POST sensor, DMA controller failed                                                                      | DMA controller failure                                                |
| Critical        | POST Err: POST sensor, Interrupt controller failed                                                                | Interrupt controller failure                                          |
| Critical        | POST Err: POST sensor, Timer refresh failed                                                                       | Timer refresh failure                                                 |
| Critical        | POST Err: POST sensor, Programmable interval timer error                                                          | Programmable interval timer error                                     |
| Critical        | POST Err: POST sensor, Parity error                                                                               | Parity error                                                          |
| Critical        | POST Err: POST sensor, SIO failed                                                                                 | SIO failure                                                           |
| Critical        | POST Err: POST sensor, Keyboard controller failed                                                                 | Keyboard controller failure                                           |

**Table C-8. Server Status Screen (continued)**

| <b>Severity</b> | <b>Message</b>                                                                                                  | <b>Cause</b>                                        |
|-----------------|-----------------------------------------------------------------------------------------------------------------|-----------------------------------------------------|
| Critical        | POST Err: POST sensor, System management interrupt initialization failed                                        | System Management Interrupt initialization failure  |
| Critical        | POST Err: POST sensor, BIOS shutdown test failed                                                                | BIOS shutdown test failure                          |
| Critical        | POST Err: POST sensor, BIOS POST memory test failed                                                             | BIOS POST memory test failure                       |
| Critical        | POST Err: POST sensor, Dell remote access controller configuration failed                                       | Dell Remote Access Controller configuration failure |
| Critical        | POST Err: POST sensor, CPU configuration failed                                                                 | CPU configuration failure                           |
| Critical        | POST Err: POST sensor, Incorrect memory configuration                                                           | Incorrect memory configuration                      |
| Critical        | POST Err: POST sensor, POST failure                                                                             | General failure after video                         |
| Critical        | Hdwar version err: Version Change sensor, hardware incompatibility was asserted                                 | Incompatible hardware was detected                  |
| Critical        | Hdwar version err: Version Change sensor, hardware incompatibility (BMC firmware) was asserted                  | Hardware is incompatible with the firmware          |
| Critical        | Hdwar version err: Version Change sensor, hardware incompatibility (BMC firmware and CPU mismatch) was asserted | CPU and firmware not compatible                     |
| Critical        | Mem Overtemp: Memory sensor, correctable ECC <DIMM Location> was asserted                                       | Memory module overheating                           |
| Critical        | Mem Fatal SB CRC: Memory sensor, uncorrectable ECC was asserted                                                 | South bridge memory failed                          |



**Table C-8. Server Status Screen (continued)**

| <b>Severity</b> | <b>Message</b>                                                                                                                      | <b>Cause</b>                                                               |
|-----------------|-------------------------------------------------------------------------------------------------------------------------------------|----------------------------------------------------------------------------|
| Critical        | Mem Fatal NB CRC: Memory sensor, uncorrectable ECC was asserted                                                                     | North bridge memory failed                                                 |
| Critical        | WatchDog Timer: Watchdog sensor, reboot was asserted                                                                                | Watch dog timer cause system to reboot                                     |
| Critical        | WatchDog Timer: Watchdog sensor, timer expired was asserted                                                                         | Watch dog timer expired but no action taken                                |
| Warning         | Link Tuning: Version Change sensor, successful software or F/W change was deasserted                                                | Failed to update link tuning setting for proper NIC operation              |
| Warning         | Link Tuning: Version Change sensor, successful hardware change <device slot number> was deasserted                                  | Failed to update link tuning setting for proper NIC operation              |
| Critical        | LinkT/ FlexAddr: Link Tuning sensor, failed to program virtual MAC address (Bus # Device # Function #) was asserted                 | Flex address could be programmed for this device                           |
| Critical        | LinkT/ FlexAddr: Link Tuning sensor, device option ROM failed to support link tuning or flex address (Mezz <location>) was asserted | Option ROM does not support Flex address or link tuning.                   |
| Critical        | LinkT/ FlexAddr: Link Tuning sensor, failed to get link tuning or flex address data from BMC/iDRAC was asserted                     | Failed to obtain linking tuning or Flex address information from BMC/iDRAC |

# LCD Module and Server Status Information

The tables in this section describe status items that are displayed on the front panel LCD for each type of component in the chassis.

**Table C-9. CMC Status**

| Item             | Description                                                                                                       |
|------------------|-------------------------------------------------------------------------------------------------------------------|
| Name/Location    | Example: CMC1, CMC2                                                                                               |
| Error Messages   | If no error then "No Errors" is shown; otherwise error messages are listed, critical errors first, then warnings. |
| IP Address       | Only shows on active CMC.                                                                                         |
| MAC Address      | Only shows on active CMC.                                                                                         |
| Firmware Version | Only shows on active CMC.                                                                                         |

**Table C-10. Chassis/Enclosure Status**

| Item                | Description                                                                                                       |
|---------------------|-------------------------------------------------------------------------------------------------------------------|
| User Define Name    | Example: "Dell Rack System". This is settable via CMC CLI or Web GUI                                              |
| Error Messages      | If no error then "No Errors" is shown; otherwise error messages are listed, critical errors first, then warnings. |
| Model Number        | Example "PowerEdgeM1000"                                                                                          |
| Power Consumption   | Current power consumption in watts                                                                                |
| Peak Power          | Peak power consume in watts                                                                                       |
| Minimum Power       | Minimum power consume in watts                                                                                    |
| Ambient Temperature | Current ambient temperature in degrees Celsius                                                                    |
| Service Tag         | The factory-assigned service tag                                                                                  |
| CMC redundancy mode | Non-Redundant or Redundant                                                                                        |
| PSU redundancy mode | Non-Redundant, AC Redundant, or DC Redundant                                                                      |

**Table C-11. Fan Status**

| <b>Item</b>    | <b>Description</b>                                                                                                |
|----------------|-------------------------------------------------------------------------------------------------------------------|
| Name/Location  | Example: Fan1, Fan2, etc.                                                                                         |
| Error Messages | If no error then "No Errors" is shown; otherwise error messages are listed, critical errors first, then warnings. |
| RPM            | Current fan speed in RPM                                                                                          |

**Table C-12. PSU Status**

| <b>Item</b>     | <b>Description</b>                                                                                                |
|-----------------|-------------------------------------------------------------------------------------------------------------------|
| Name/Location   | Example: PSU1, PSU2, etc.                                                                                         |
| Error Messages  | If no error then "No Errors" is shown; otherwise error messages are listed, critical errors first, then warnings. |
| Status          | Offline, Online, or Standby                                                                                       |
| Maximum Wattage | Maximum Wattage that PSU can supply to the system                                                                 |

**Table C-13. IOM Status**

| <b>Item</b>    | <b>Description</b>                                                                                                |
|----------------|-------------------------------------------------------------------------------------------------------------------|
| Name/Location  | Example: IOM A1, IOM B1.                                                                                          |
| Error Messages | If no error then "No Errors" is shown; otherwise error messages are listed, critical errors first, then warnings. |
| Status         | Off or On                                                                                                         |
| Model          | Model of the IOM                                                                                                  |
| Fabric Type    | Networking type                                                                                                   |
| Service Tag    | The factory-assigned service tag.                                                                                 |
| IP address     | Only shows if IOM is On. Will be all zero for a pass through type IOM.                                            |
| MAC            | Only shows if IOM is On. Will be all zero for a pass through type IOM.                                            |

**Table C-14. iKVM Status**

| <b>Item</b>       | <b>Description</b>                                                                                                |
|-------------------|-------------------------------------------------------------------------------------------------------------------|
| Name              | iKVM                                                                                                              |
| Error Messages    | If no error then "No Errors" is shown; otherwise error messages are listed, critical errors first, then warnings. |
| Status            | Off or On                                                                                                         |
| Model/Manufacture | A description of the iKVM model.                                                                                  |
| Service Tag       | The factory-assigned service tag.                                                                                 |
| Part Number       | The manufacturer part number.                                                                                     |
| Firmware Version  | The iKVM firmware version.                                                                                        |

**Table C-15. Server Status**

| <b>Item</b>            | <b>Description</b>                                                                                                                                         |
|------------------------|------------------------------------------------------------------------------------------------------------------------------------------------------------|
| Name/Location          | Example: Server 1, Server 2.                                                                                                                               |
| Error Messages         | If no error then "No Errors" is shown; otherwise error messages are listed, critical errors first, then warnings.                                          |
| Slot Name              | CMC slot name. Example SLOT-01. Note: this is settable via CMC CLI or Web GUI.                                                                             |
| Name                   | User settable name of the server. Settable via server BIOS, iDRAC CLI or Web GUI. Only shows if iDRAC finished booting, else shows iDRAC booting messages. |
| Model Number           | Only shows if iDRAC finished booting                                                                                                                       |
| Service Tag            | Only shows if iDRAC finished booting                                                                                                                       |
| iDRAC IP Address       | Only shows if iDRAC finished booting<br>If iDRAC is set for DHCP and has not obtained IP then will show Acquiring                                          |
| iDRAC MAC Address      | Only shows if iDRAC finished booting                                                                                                                       |
| iDRAC Firmware Version | Only shows if iDRAC finished booting                                                                                                                       |

**Table C-15. Server Status (continued)**

| <b>Item</b>                                    | <b>Description</b>                                                                                                      |
|------------------------------------------------|-------------------------------------------------------------------------------------------------------------------------|
| FlexAddress enabled<br>on Fabrics:<br><Fabric> | Only shows if feature is installed. Lists fabrics that are<br>FlexAddress enabled for this server (for example A, B, C) |



# Glossary

## **Active Directory**

Active Directory is a centralized and standardized system that automates network management of user data, security, and distributed resources, and enables interoperation with other directories. Active Directory is designed especially for distributed networking environments.

## **ARP**

Address resolution protocol, a method for finding a host's Ethernet address from its Internet address.

## **ASCII**

American Standard Code for Information Interchange, a code representation used for displaying or printing letters, numbers, and other characters.

## **blade**

Another term for server

## **BIOS**

Basic input/output system, the part of system software that provides the lowest-level interface to peripheral devices and which controls the first stage of the system boot process, including installation of the operating system into memory.

## **CMC**

The Dell Chassis Management Controller, providing remote management capabilities and power control functions for Dell PowerEdge™ systems.

## **bus**

A set of conductors connecting the various functional units in a computer. Busses are named by the type of data they carry, such as data bus, address bus, or PCI bus.

## **CA**

A certificate authority is a business entity that is recognized in the IT industry for meeting high standards of reliable screening, identification, and other important security criteria. Examples of CAs include Thawte and VeriSign. After the CA receives your CSR, they review and verify the information the CSR contains. If the applicant meets the CA's security standards, the CA issues a certificate to the

applicant that uniquely identifies that applicant for transactions over networks and on the Internet.

**CD**

Compact disc

**Certificate Signing Request (CSR)**

A digital request to a certificate authority for a secure server certificate.

**CLI**

Command Line interface

**DHCP**

Dynamic host configuration protocol, a means of dynamically allocating IP addresses to computers on a local area network.

**DLL**

Dynamic link library, a library of small programs, any of which can be called when needed by a larger program that is running in the system. The small program that lets the larger program communicate with a specific device such as a printer or scanner is often packaged as a DLL program (or file).

**DNS**

Domain name system

**iDRAC**

The Dell Integrated Remote Access Controller, a systems management hardware and software solution that provides remote management capabilities, crashed system recovery, and power control functions for Dell PowerEdge systems.

**delay time (OSCAR user interface)**

The number of seconds before the OSCAR Main dialog box is displayed after <Print Screen> is pressed.

**extended schema**

A solution used with Active Directory to determine user access to the CMC; uses Dell-defined Active Directory objects.



**FQDN**

Fully qualified domain name, a domain name that specifies a module's absolute position in the DNS tree hierarchy. Microsoft® Active Directory® only supports an FQDN of 64 bytes or fewer.

**FSMO**

Flexible single master operation, a Microsoft Active Directory domain controller task that guarantees atomicity of an extension operation.

**GMT**

Greenwich Mean Time. GMT is the standard time common to every place in the world. GMT nominally reflects the mean solar time along the prime meridian (0 longitude) that runs through the Greenwich Observatory outside of London, UK.

**GUI**

Graphical user interface, which refers to a computer display interface that uses elements such as windows, dialog boxes, and buttons as opposed to a command prompt interface, in which all user interaction is displayed and typed in text.

**hardware log**

A CMC-generated record of events relating to hardware on the chassis.

**ICMP**

Internet control message protocol, a way for operating systems to send error messages.

**ID**

Identifier, commonly used when referring to a user identifier (user ID) or object identifier (object ID).

**iKVM**

Avocent® Integrated KVM Switch Module, an optional, hot-pluggable module to the chassis providing local access to keyboard, mouse, and video to any of the 16 servers in the chassis, as well as the additional Dell CMC Console option that connects to the chassis' active CMC.

**IP**

Internet Protocol. IP is the network layer for TCP/IP. IP provides packet routing, fragmentation, and reassembly.

**IPMB**

Intelligent platform management bus, which is used in systems management technology.

**Kbps**

Kilobits per second, a data transfer rate.

**LAN**

Local area network

**LDAP**

Lightweight directory access protocol

**LED**

Light-emitting diode

**LOM**

Local area network on motherboard

**MAC**

Media access control, a network sublayer between a network node and the network physical layer.

**MAC address**

Media access control address, a unique address embedded in the physical components of a NIC.

**management station**

A system that remotely accesses the CMC.

**Mbps**

Megabits per second, which is a data transfer rate.

**Microsoft Active Directory**

A centralized, standardized system that automates network management of user data, security, and distributed resources, and enables interoperability with other directories. Active Directory is designed especially for distributed networking environments.

**NIC**

Network interface card, an adapter circuit board installed in a computer to provide a physical connection to a network.

**OID**

Object identifier

**OSCAR**

On Screen Configuration and Reporting, a graphical user interface used for iKVM access.

**PCI**

Peripheral component interconnect, a standard interface and bus technology for connecting peripherals to a system and for communicating with those peripherals.

**POST**

Power-on self-test, a sequence of diagnostic tests that are run automatically by a system when it is powered on.

**RAC**

Remote access controller

**RAM**

Random-access memory. RAM is general-purpose readable and writable memory on systems.

**RAM disk**

A memory-resident program which emulates a hard drive.

**RAC**

Remote access controller

**ROM**

Read-only memory, from which data may be read, but to which data cannot be written.

**RPM**

Red Hat Package Manager, a package-management system for the Red Hat Enterprise Linux operating system. RPM helps installation of software packages. It is similar to an installation program.

**SEL**

System event log

**SMTP**

Simple mail transfer protocol, used to transfer electronic mail between systems—usually over an Ethernet.

**SNMP**

Simple network management protocol, designed to manage nodes on an IP network. iDRACs are SNMP-managed devices (nodes).

**SNMP trap**

A notification (event) generated by the CMC that contains information about state changes on the managed system or about potential hardware problems.

**SSH**

Secure Shell, a network protocol that allows data to be exchanged over a secure channel between two computers.

**SSL**

Secure sockets layer, a protocol that provides secure communications over networks for data transfers.

**standard schema**

A solution used with Active Directory to determine user access to the CMC; uses Active Directory group objects only.

**TCP/IP**

Transmission control protocol/Internet protocol, representing the set of standard Ethernet protocols that includes the network layer and transport layer protocols.

**TFTP**

Trivial file transfer protocol, a simple file transfer protocol used for downloading boot code to diskless devices or systems.

**UPS**

Uninterruptible power supply

**USB**

Universal serial bus, a serial bus standard to interface devices.

**UTC**

Universal Coordinated Time. *See* GMT.

**vKVM**

Virtual keyboard-video-mouse console

**VLAN**

Virtual local area network

**VNC**

Virtual network computing

**VT-100**

Video Terminal 100, which is used by the most common terminal emulation programs.

**WAN**

Wide area network



# Index

## A

ACI, 227

Active Directory, 167-194

- adding CMC users, 180
- configuring access to the CMC, 173
- configuring and managing certificates, 117
- extending schemas, 173
- objects, 169
- schema extensions, 168
- using with standard schema, 187

adding

- SNMP alerts, 260

alerts

- troubleshooting, 283

Analog Console Interface, 225

## C

Certificate Signing Request (CSR)

- about, 124
- generating a new certificate, 125

certificates

- Active Directory, 117
- SSL and digital, 123
- uploading a server certificate, 128
- viewing a server certificate, 128

cfgAlerting, 365

CMC

- configuring, 183, 190
- creating a configuration file, 81
- downloading firmware, 48
- feature sets, 23
- installing, 33
- log, 275
- redundant environment, 51
- setting up, 33

command line console

- features, 53

configuration file

- creating, 81

configuring

- CMC from the LCD panel, 48
- CMC remote RACADM, 46
- power budgeting, 48
- remote RACADM, 46
- SNMP alerts, 260

connect command

- CMC command line connection, 63

## F

fabric management, 251-258

feature sets of CMC, 23

featurecard, 153

- firmware
  - downloading, 48
  - managing, 138
- FlexAddress, 151
  - activating, 152
  - activation verification, 153
  - configuring using CLI, 156
  - deactivating, 155
  - license agreement, 163
  - Linux configuration, 157
  - troubleshooting, 158
  - viewing status using CLI, 156
  - Wake-On-LAN, 157
- frequently asked questions
  - managing and recovering a remote system, 148
  - using the CMC with Active Directory, 194

## H

- hardware log, 273
- hardware specifications, 25

## I

- I/O fabric, 251-258
- iDRAC
  - recovering firmware, 140

- iKVM, 225
- installing CMC, 33

## L

- LDC panel
  - configuring CMC from, 48
- logs
  - CMC, 275
  - hardware, 273

## M

- managed system
  - accessing through the local serial port, 53
- management station
  - configuring terminal emulation, 55
- Microsoft Active Directory, 167-194

## N

- network properties
  - configuring manually, 72
  - configuring using racadm, 72

## O

- OSCAR, 225



## P

- parsing rules, 83
- power budgeting
  - configuring, 48
- power conservation, 201
- property database groups
  - cfgActiveDirectory, 371
  - cfgChassisPower, 375
  - cfgCurrentLanNetworking, 352
  - cfgEmailAlert, 357
  - cfgKVMInfo, 381
  - cfgLanNetworking, 349
  - cfgNetTuning, 362
  - cfgOobSnmp, 363
  - cfgRacSecurity, 369
  - cfgRacTuning, 366
  - cfgRemoteHosts, 353
  - cfgSerial, 360
  - cfgServerInfo, 379
  - cfgSessionManagement, 358
  - cfgStandardSchema, 373
  - cfgTraps, 364
  - cfgUserAdmin, 354
  - displayable characters, 347
  - idRacInfo, 347
- proxy server, 36

## R

### RAC

- see Remote Access Connection, 27

### RACADM

- uninstalling from Linux management station, 35

### RACADM subcommands

- ?, 285
- arp, 286
- chassisaction, 287
- clrraclog, 288
- clrsel, 289
- cmcchangeover, 289
- config, 290
- deploy, 292
- feature, 294
- featurecard, 295
- fwupdate, 296
- getassettag, 298
- getchassisname, 299
- getconfig, 299
- getdcinfo, 302
- getflexaddr, 303
- getioinfo, 305
- getkvminfo, 306
- getled, 306
- getmacaddress, 307
- getmodinfo, 308
- getniccfg, 309
- getpbinfo, 311
- getraclog, 313
- getractime, 314
- getredundancymode, 315
- getsel, 315
- getsensorinfo, 316
- getslotname, 317
- getssninfo, 318
- getsvctag, 319

## RACADM subcommands

(*continued*)

getsysinfo, 321

gettracelog, 322

help, 324

ifconfig, 325

racdump, 326

racreset, 329

racresetcfg, 330

serveraction, 331

setchassisname, 332

setflexaddr, 333

settled, 335

setniccfg, 335

setractime, 337

setslotname, 339

setsysinfo, 340

sslcertdownload, 340

sslcertupload, 341

sslcertview, 342

sslcsrgen, 344

testemail, 345

testtrap, 346

## racadm utility

configuring network

properties, 72

parsing rules, 83

subcommands, 285

## Red Hat Enterprise Linux

configuring for serial console

redirection, 58

redundant environment, 51

remote access connection

(RAC), 27

remote RACADM

configuring, 46

## S

Secure Sockets Layer (SSL)

about, 123

security

using SSL and digital  
certificates, 123

serial console

using, 63

server certificate

uploading, 128

viewing, 128

services

configuring, 130

setting up CMC, 33

slot names

editing, 91

naming rules, 91

setting with RACADM, 339

snap-in

installing the Dell extension, 179

SNMP alerts

adding and configuring, 260

specifications

hardware, 25

sslcertdownload, 340

standard schema

using with Active Directory, 187

## **T**

telnet console  
    using, 63

## **W**

web browser  
    configuring, 35  
    supported browsers, 27  
web interface  
    accessing, 87  
    configuring email alerts, 265  
WS-Management, 28

